

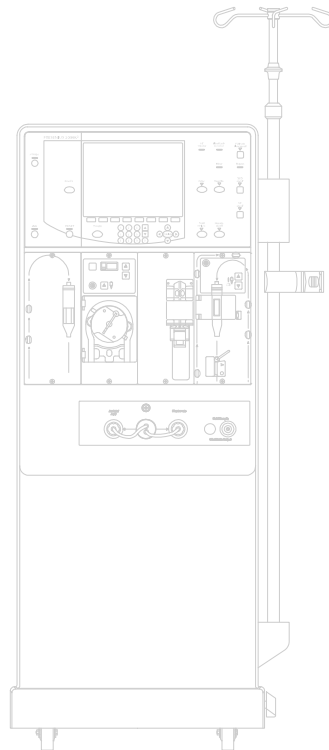

2008K² Hemodialysis Machine

Operator's Manual



P/N 490136 Rev K
For Functional board software ver. 5.40 or later

2008K² Hemodialysis Machine Operator's Manual

© Copyright 2008 - 2018 Fresenius USA, Inc.—All Rights Reserved

This document contains proprietary information of Fresenius Medical Care Renal Therapies Group, LLC and its affiliates (“Fresenius Medical Care”). The contents of this document may not be disclosed to third parties, copied, or duplicated in any form, in whole or in part, without the prior written permission of Fresenius Medical Care.

Fresenius Medical Care, the triangle logo, 2008, Combiset, Twister, NaturaLyte, GranuFlo, Optiflux, DIASAFE and PURISTERIL are trademarks of Fresenius Medical Care Holdings, Inc., and/or its affiliated companies. Citrasate is a registered trademark of Advanced Renal Technologies, Inc. in the United States and used under license from Advanced Renal Technologies, Inc. All other trademarks are the property of their respective owners.

Caution: *US Federal law restricts this device to sale only by or on the order of a physician. Frequency, duration, and parameters of treatment are to be determined by the prescribing physician.*

Note: *Not all features are available in all regions.*

*The 2008K² hemodialysis machine is manufactured by:
Fresenius USA, Inc.
4040 Nelson Avenue
Concord, CA 94520*

Installation, maintenance, calibration and other technical information may be found in the 2008K² Technician's Manual, P/N 490137.

Contact Fresenius Medical Care Technical Support for applicable Field Service Bulletins. The spare parts manual for the model 2008K² and other information may be found on our web site at www.fmcna.com

Indications for use: The 2008K² Hemodialysis Machine is indicated for acute and chronic hemodialysis therapy in a healthcare facility.

Additional therapy options for patients receiving hemodialysis include: Isolated Ultrafiltration, Sustained Low Efficiency Dialysis (SLED), and low volume hemodialysis (patients weighing ≥ 20 kg and ≤ 40 kg). This machine accommodates the use of both low flux and high flux dialyzers. The SLED therapy option is not to be used for patients weighing ≤ 40 kg. The 2008K² Hemodialysis Machine is not to be used for plasma replacement therapies, for patients weighing less than 20 kg, or for renal therapies using substitution fluid.

Contents

About this manual.....	7
Requirements	8
Related Reading	8
Conventions	9
About Hemodialysis.....	11
General Warnings	13
Using a Central Venous Catheter.....	18
CHAPTER 1	
Overview.....	20
Function of the 2008K ² Hemodialysis Machine	20
Organization of the 2008K ² Hemodialysis Machine	20
The Control Panel	23
Control Panel Keys	24
Modules	31
The Dialysate Path	37
IV Pole and Dialyzer Holder.....	40
Moving the Machine	41
CHAPTER 2	
Daily Preparation for Treatment	43
Starting Point	43
Preparing the Dialysis Delivery System	44
Preparing the Extracorporeal Blood Circuit.....	45
Connecting the Extracorporeal Blood Circuit.....	47
Testing the 2008K ² Hemodialysis Machine.....	52
Recirculation and Final Set-Up Procedure.....	55
CHAPTER 3	
Setting Treatment Parameters	57
Recommended Screen Order	57
New Treatment Key.....	58
Entering a Parameter.....	59
Dialysate Screen Settings.....	60
Home Screen Settings	71

Ultrafiltration	75
Sodium Variation System	80
Heparin Screen Settings	84
Test & Options Screen Settings	89
Low Volume Dialysis	91
Blood Pressure Screen Settings	92
Starting Dialysis.....	95
 CHAPTER 4	
Monitoring the Treatment	96
Home Screen Monitoring.....	97
Trends Screen Monitoring	102
Kt/V & Access Flow Monitoring.....	105
Blood Temperature Monitor/ Blood Volume Monitor Screen.....	113
Blood Pressure Screen Monitoring	116
During Treatment.....	117
Blood Recirculation Procedure	118
Power Failure during Dialysis	119
Completion of Dialysis	122
 CHAPTER 5	
Disinfection and Maintenance	125
Cleaning and Disinfection.....	125
Cleaning the Exterior Surface.....	128
Rinse Program.....	130
Acid Clean Program.....	131
Heat Disinfection	132
Chemical/Rinse Program	133
Chemical/Dwell Program.....	135
 CHAPTER 6	
Alarms and Troubleshooting.....	138
Operational Status.....	138
Troubleshooting	142
Replacing the Diasafe Plus Filter.....	187
Replacing the 9-Volt Battery	187
 APPENDIX A	
Single Needle Dialysis (Optional)	189
 APPENDIX B	

Concentrate Types	207
Adding New Concentrates or Changing the Type	209
Creating Custom UF Profiles.....	213
Auto Flow and Idle Mode	214
Auto Heat Disinfect	218
Available Software & Hardware Treatment Options and Default Settings	220
Equipment Storage and Maintenance	225
Machine Specifications.....	226
Manufacturer’s EMC Declaration.....	235
Product Improvement Policy	237
Warranty	237
APPENDIX C	
Glossary	239
Index	244

This page intentionally blank

About this manual...

The purpose of the *2008K² Hemodialysis Machine Operator's Manual* is to instruct qualified patient-care staff in the function, operation, and maintenance of the 2008K² hemodialysis machine. It is not intended as a guide for performing hemodialysis, a medical treatment that should only be performed under the supervision of a licensed physician.

This manual is organized to systematically guide a patient-care specialist through the set up, operation, and clean up of the 2008K² hemodialysis machine in daily use. The book begins with an overview that introduces the operator to the major components and describes how they are organized on the machine. Next, the operator is guided through a daily set-up procedure. Once the machine has been prepared for daily use, a step-by-step guide to preparing the machine for a patient-specific treatment is provided. The operator is then provided a tour of the various treatment screen functions useful in monitoring the treatment, followed by instruction in terminating treatment and post-treatment clean up. Also included are sections on troubleshooting, maintenance, and treatment options.

The organization of the 2008K² Hemodialysis Machine Operator's Manual is as follows:

- **Preface**

Identifies the intended audience, and describes how the manual is organized. It addresses various issues regarding the performance of hemodialysis and product liability, and provides information for contacting Fresenius USA, Inc.

- **Chapter 1—Overview**

Introduces the operator to the 2008K² hemodialysis machine, its features, their functions, and how they are organized on the machine through pictures and descriptions.

- **Chapter 2—Daily Preparation for Treatment**

Provides instructions on the recommended methods of preparing the 2008K² hemodialysis machine for daily, standard-dialysis operation.

- **Chapter 3—Setting Treatment Parameters**

Describes how to enter treatment data, and guides the operator through the relevant, treatment screens to enter patient-specific, treatment parameters in their recommended order. The chapter also covers the procedure for beginning dialysis treatment.

- **Chapter 4—Monitoring and the Completion of Treatment**

Guides the user through the screens used to monitor the dialysis treatment. It explains the features of each screen and describes the information displayed. The screens that provide a general overview of the treatment status are provided first, followed by the screens providing more in-depth data that are narrower in scope. It concludes with a description of the recommended, end-of-treatment procedure.

- **Chapter 5—Cleaning and Disinfection**

Recommendations for scheduled cleaning and disinfection, as well as maintenance procedures that should be performed by the operator are found here.

- **Chapter 6—Alarms and Troubleshooting**

This chapter is indexed by alarm messages to provide the operator a quick-reference guide for determining the cause and remedies for alarms and warning situations.

- **Appendices**

In addition, this manual includes several appendices covering optional hemodialysis treatments such as single-needle hemodialysis, and Sustained Low Efficiency Dialysis (SLED) and provides information on the setup, customizing, storage and specifications of the 2008K² hemodialysis machine.

- **Glossary**

A glossary of terms is included

- **Index**

An index to aid the operator in referencing information is included

Requirements

Operators of the 2008K² hemodialysis machine must be trained to administer hemodialysis at the direction of a physician. In addition, the operator should be:





















- Knowledgeable of hemodialysis methodology and relevant physiology.
- Proficient in healthcare procedures regarding aseptic techniques.
- Thoroughly familiar with the contents of this manual.
- Fully trained and qualified to operate this machine, and able to distinguish between normal and abnormal operation.

Related Reading

The following documents contain information on related to the 2008K² hemodialysis machine:

- 2008K² Technicians Manual (P/N 490137)
- 2008K² Calibration Procedures Manual (P/N 508137)
- 2008K² Preventive Maintenance Procedures Manual (P/N 508138)
- 2008K/K² Troubleshooting Guide (P/N 507298)
- 2008K/K@home/K² Spare Parts Manual (P/N 490124)
- 2008K² Installation Checklist (P/N 490138)
- 2008K² Installation Checklist Instructions (P/N 508136)
- 2008K² Field Service Bulletins may be obtained from the Fresenius Medical Care North America (FMCNA) website: www.FMCNA.com or contact your clinic for more information.
- Comments are available concerning the expected increased recirculation of blood in the extracorporeal circuit during single needle treatment when using the recommended administration sets, dialyzers, catheters, and fistula needles.

Conventions

Symbol	Description
 and 	Warning! A warning is a statement that identifies conditions or actions that could result in personal injury or loss of life. Warnings found in this manual outside of this section are designated with the warning symbol.
 and 	Shock Hazard: A shock hazard warning refers to a risk of a possibly severe electrical shock due to improper use or handling of the equipment.
	Corrosive Substance Hazard: A corrosive substance hazard warning refers to a risk of injury or machine damage due to improper use or handling of the equipment.
	Hot Surface, Fluid, or Vapors Hazard: A hot surface, fluid, or vapors hazard warning refers to risk of burn injury due to improper use or handling of the equipment.
	Caution: A caution is a statement that identifies conditions or actions that could result in damage to the machine.
	Mandatory Action: A command describing required action to maintain safety.
	Note: Notes are advisory comments or recommendations regarding practices or procedures.
	Do not reuse
 and 	ON: This symbol, at the top of the switches on the back of your machine, means the switch is in the ON position.
 and 	OFF: This symbol, at the bottom of the switches on the back of your machine, means the switch is in the OFF position.
	Degree of protection against electric shock: Type B
	Degree of protection against electric shock: Type CF – Blood Pressure Cuff only
	MR Unsafe: An item which poses unacceptable risks to the patient, medical staff or other persons within the MR (Magnetic Resonance) environment.
	Protective ground terminal
	Ground terminal
	Equipotentiality

Name	Description
Button	A button refers to specific fields <u>located in the treatment screens</u> that are used to set treatment parameters or perform an action when selected.
Control Panel	The control panel is located at the top third of the 2008K ² machine and contains the display screen and panel keys used in controlling the treatment.
Display Screen	The area located in the middle of the control console that displays the treatment screens.
Key	A key is a pressure-sensitive, raised pad found on the control panel <u>outside of the treatment screen</u> that is used to enter a value, make a selection, or initiate an action or process.
Screen	The graphic image displayed inside the display screen. There are eight main screens all of which are accessible from any of the other screens.
Subscreen	A smaller screen that can be opened from inside a particular main screen. Subscreens are not accessible from all main screens.

About Hemodialysis...

Indications

Hemodialysis is prescribed by physicians for patients with acute or chronic renal failure, when conservative therapy is judged inadequate. Dialysis therapy may be intermittent or continuous.

Contraindications

There are no absolute contraindications to hemodialysis, but the passing of a patient's blood through an extracorporeal circuit may require anticoagulation to prevent blood clotting. In addition, the parameters of dialysis should be optimized to avoid discomfort to the patient. Many patients are taking medicinal therapy prescribed by their physicians. Due to the dialysis treatment, some of the medication may be removed from the patient's blood thereby lowering the therapeutic level in the blood. In other cases, medications may not be excreted as quickly as expected with patients with renal insufficiency and the level may be higher than expected. Therefore, the prescribing physician should determine the appropriate dosage of the medicine to obtain the desired medicinal response in the patient.

Some Side Effects of Hemodialysis

Dialysis therapy occasionally causes hypovolemia, hypervolemia, hypertension, hypotension and related symptoms, headache, nausea, cramping or other muscular discomfort in some patients. Hypothermia, hyperthermia, itching, anxiety, convulsions, seizure, and other neurologic symptoms associated with dialysis dementia may also be manifested by the patient. These symptoms are thought to occur if the patient's blood volume or electrolyte balance is not maintained within acceptable limits. Other, more serious, complications arising from dialysis, such as hemorrhage, air embolism, or hemolysis, can cause serious patient injury or death. The prescribing physician must understand that prescribing insufficient bicarbonate may contribute to metabolic acidosis; excessive bicarbonate may contribute to metabolic alkalosis. Both conditions are associated with poor patient outcomes, including increased risk of mortality. Proper control of all elements of dialysis may prevent or control these physiological reactions or complications.

Pyrogenic reactions may occur which can result in patient injury. Generally it is thought that these may be controlled by maintaining the dialysate solution within the chemical and bacteriologic limits (see Water Quality on page 227 of the "Machine Specifications" section for more information). Failure to use these standards for water can also lead to accumulated toxic effects. A regular program for disinfection and testing of the water treatment system, piping, inlet lines, filters, concentrate feed containers or system, and the dialysate delivery machine must be established and followed. This program will vary from facility to facility.

Infections or pyrogen reactions may also result from contamination of the extracorporeal circuit or inadequate procedures used to reuse dialyzers.

Allergic reactions to chemical disinfectants may occur if insufficient procedures are used to remove or maintain the residual disinfectant at acceptable levels. Chemical disinfectants are used for dialyzer disinfection, machine disinfection, or for disinfection of water treatment and distribution systems.

All blood connections must be made using aseptic technique.

All tubes and connections must be secured and closely monitored to prevent loss of blood or entry of air into the extracorporeal circuit or errors in the ultrafiltration control system. The patient may require blood transfusion or other medical intervention to prevent respiratory or cardiac disorders if these occur.

The patient's blood pressure and general physical status must be closely monitored during dialysis in order to initiate appropriate remedial measures or therapy. Of particular importance is the control of the patient's serum potassium level to prevent cardiac dysrhythmia and the patient's blood clotting time to prevent clotting disorders.

These instructions are for the 2008K² hemodialysis machine. The machine must only be operated in accordance with these instructions. All operators of this machine must be thoroughly trained and have read this entire manual and any applicable appendices before using the machine. Improper care/use of this device may result in serious patient injury or death.

Blood Pressure Module Contraindications

The following are generally accepted contraindications for using a timed automatic blood pressure instrument utilizing the oscillometric principle:

- Use of a heart lung machine
- Peripheral circulation problems
- Severe arrhythmia
- Ectopic beats
- Convulsions
- Spasms
- Tremors
- Tachycardia

Use of incorrectly sized blood pressure cuffs may result in inaccurate blood pressure readings.

This is a guideline only. Final determination of the suitability of any medical instrument for use with any patient is the responsibility of the treating physician.

General Warnings

This section contains general warnings statements regarding the use and maintenance of the 2008K² hemodialysis machine. It is not a complete summary, and additional warning statements specific to pertinent topics can be found within this manual.

Water



Warning! Connect water inlet according to the specifications for the machine. For further information, see Appendix B, “Machine Specifications.” The correct ionic concentration and bacterial quality can generally be achieved in the dialysate only with treated water that meets water quality standards (see Water Quality and Dialysate Quality on page 227 of the “Machine Specifications” section for more information). Be sure that all specifications are satisfied. The water source must be monitored periodically to detect fluctuations in water composition and quality that could have an adverse effect on the patient or dialysate delivery machine. Particular attention must be taken for chemicals such as aluminum, chlorine, and chloramine, as these chemicals can cause complications in dialysis patients.



Warning! Comply with all local regulations in respect of separation of devices in the water supply in case of back siphonage; an air gap must be created between the machine’s drain line and its drain.

Concentrates



Warning! The specific acid and bicarbonate concentrates, including the sodium, bicarbonate, and electrolyte compositions, must be prescribed by a physician.



Warning! Many concentrate types are available for use in dialysate delivery machines. Concentrates contain various amounts of dextrose, potassium, calcium, sodium, chloride, magnesium, and other components. Most concentrates are designed as a two-part system of acid and bicarbonate solutions which are mixed in the machine with water. Even within the subgroup of bicarbonate type concentrates, there are at least four methods of compounding the solutions. Each of these methods requires special calibrations or setups. Certain methods are not supported. It is mandatory that the acid and bicarbonate types be matched to each other. Be sure to use compatible solutions, labeling, and setups. These setups include machine calibration, special adapters for certain concentrate types, correct setting of concentrate option, and labeling. Failure to use the properly matched solutions and machine calibrations may allow improper dialysate to be delivered to the patient, resulting in patient injury or death. Verify composition, conductivity, and pH after converting to a different type of concentrate.



Warning: Acid concentrate, bicarbonate concentrate, and water must be of the appropriate quality to ensure safety and performance of the final dialysate are met (see Concentrate Quality on page 227 of the “Machine Specifications” section for more information).



Warning! Connection to a central acid or bicarbonate feed system requires the installation of certain mechanical parts. Contact Fresenius USA, Inc. for more information.



Warning! Bicarbonate and acid concentrates intended for other dialysate delivery machines will deliver safe dialysate solution only if the machine is set up for them. The selection of other dialysate concentrate types must be done by a qualified, authorized person. The 2008K² hemodialysis machine can be set up for various concentrate types. Use Table 35 in Appendix B to ensure that you have compatible concentrates and configurations.



Warning! Acid concentrate products are used as one component in mixing dialysate bath. These acid products contain chemical compounds that, after mixing, yield acetate (and citrate in certain products) in the dialysate. (Please refer to the acid concentrate product labeling for specific acetate/citrate amounts.) After diffusion across the dialyzer membrane, acetate (and citrate when present) is metabolized by the liver to serum bicarbonate and adds to the serum bicarbonate that separately results from the diffusion of dialysate bicarbonate across the dialyzer membrane. During dialysis, the dynamic of diffusion and concentration gradients prevent serum bicarbonate concentration from exceeding the dialysate bicarbonate concentration. The bicarbonate concentration of the dialysate is the “bicarbonate” setting on the dialysis machine, and is the bicarbonate dose prescribed by the physician. On the 2008 series hemodialysis machines, the bicarbonate dose may be set in a range between 20 and 40 milliequivalents per liter, but may be set in different ranges in other machines.

When the dialysis session terminates, acetate (and citrate when present) that has not yet metabolized may remain in the blood and will be converted to serum bicarbonate after diffusion ceases, without possibility of diffusion out of the blood. The post dialysis metabolism of acetate (and citrate when present) could thus briefly increase serum bicarbonate concentration above the prescribed bicarbonate concentration of the dialysate. Physicians should consider this possibility in prescribing bicarbonate dose.

Prescription of insufficient bicarbonate may contribute to metabolic acidosis; excessive bicarbonate may contribute to metabolic alkalosis. Both conditions are associated with poor patient outcomes, including increased mortality risk.



Warning! Incorrect composition will result if the acid concentrate nozzle is not connected to the appropriate acid concentrate or the bicarbonate concentrate nozzle is not connected to the appropriate bicarbonate solution. The acid and bicarbonate concentrates must match those selected in the Dialysate screen. Patient injury or death may occur if incorrect dialysate solution is used. Fresenius USA, Inc. recommends the operator use the concentrate containers provided with the machine. These containers, being of different size and shape, help to reduce the chances of mismatching the acid and bicarbonate concentrates.



Warning! The operator should always check conductivity and approximate pH of the dialysate with an independent device *prior* to initiating treatment and whenever concentrates are changed during operation.



Warning! Use of an acid concentrate intended for a 1:44 mix ratio in any 1:34 proportioning dialysate delivery machine may result in a dialysate solution with a normal conductivity but without a physiological buffer. There may be no alarms in this event. Use of this improper dialysate solution may cause patient injury or death.



Warning! The machine must be labeled to indicate the type of concentrate for which it is configured. Check the composition (i.e., Na, Cl, K, Ca, Mg, HCO₃) and pH of the dialysate solution after the machine is installed or after the machine is modified for different concentrate types. Check the conductivity and approximate pH of the dialysate solution with an independent device before initiating dialysis. Improper conductivity or pH could result in patient injury or death.

Machine



Warning! Failure to install, operate, and maintain this equipment according to the manufacturer's instructions may cause patient injury or death.



Warning! Do not use devices emitting strong electromagnetic radiation such as portable phones, radio equipment (walkie-talkies, etc.), radio transmitters, and like equipment near your machine. Improper operation may result.

Cellular phones and WiFi connected devices may be conditionally allowed. However, if any interference is noted, such as false pressure readings that disappear when the external signal is removed, it is recommended to move the cellular phone at least ten feet away from the 2008K² hemodialysis machine when making or receiving phone calls. If a WiFi-connected device (e.g. laptop computers, tablet devices, smartphones) is found to cause interference, it is recommended to use that device at least four feet away from the 2008K² hemodialysis machine.

For exact separation distance recommendation, please refer to the Manufacturer's EMC Declaration statement on page 235.



Warning! Never perform maintenance when a patient is connected to the machine. If possible, remove the machine from the treatment area when it is being serviced. Label the machine to ensure it is not accidentally returned to clinical use before the service work is completed. Disinfect the machine and test the dialysate for acceptable conductivity and pH values before returning the machine to clinical use. Always test the machine when maintenance is completed.



Warning! The electrical source must be single phase, three-conductor type provided with a hospital grade receptacle and a ground fault interrupter at 120 volts, 60 Hz. The proper polarity and ground integrity must be initially checked and maintained. Failure to do so may result in electrical shock or burn to the operator or patient. The machine must be plugged directly into the electrical outlet; extension cords and power strips are prohibited.



Warning! Shock hazard. Do not remove covers. Refer servicing to qualified personnel. Replace fuses only with the same type and rating.



Warning! Do not install the 9-Volt battery backwards in the machine, as it will damage the "No Power" alarm.



Warning! Proper functioning of the machine must be verified prior to initiating treatment. Unidentified malfunctions or alarm failure could potentially expose a patient to a serious health risk. Alarm limits for the arterial pressure monitor, venous pressure monitor, and transmembrane pressure (TMP) monitor are automatically set and delayed for pressure stabilization. Alarm limits for temperature and conductivity are calculated for the dialysate composition and may be somewhat adjusted by the operator. These must be maintained within safe physiological limits as specified by the prescribing physician.



Warning! Transducer protectors should be used between pressure ports and each pressure monitor line of the extracorporeal system to prevent the internal transducer protectors from getting wet. Wet transducer protectors must be replaced, as they will cause inaccurate pressure readings. If the external transducer protector and the internal transducer protector become contaminated with blood, the transducer protectors **must** be replaced and the transducer and associated parts must be disinfected or replaced.



Warning! Possible Explosion Hazard if used in the presence of flammable anesthetics.



Warning! A new, sterile transducer protector should be placed on all the air connections from the drip chambers to the machine pressure monitor ports. This will prevent contamination of the machine and filters air that enters the chambers through the monitor lines. If the transducer protector should get wet and air is not able to pass, replace the transducer protector and clear the monitor line.



Warning! The machine is compatible with a number of venous lines. The Level Detector module must be calibrated for the model venous line being used. In addition, verify that the venous line clamp is capable of fully occluding the model of bloodline that your facility uses.



Warning! To avoid damaging the equipment or personal injury, internal adjustments to the blood pressure module should only be made by a qualified technician.



Warning! Check all bloodlines for leaks after the treatment has started. Keep access sites uncovered and monitored. Improper bloodline connections or needle dislodgements can result in excessive blood loss, serious injury, and death. Machine alarms may not occur in every blood loss situation.



Warning! The dialysate path is a closed fluidics system. Discontinue use immediately if a fluid leak is detected. Do not attempt to administer or continue dialysis treatment with a machine which has a fluid leak, this could result in excessive fluid removal from the patient leading to serious injury or death. System leaks may also pose a slip-and-fall hazard. Clean up spills immediately.



Caution: System leaks may occur. Unattended operation of the machine (for example, during disinfection at night) may result in flooding and can cause property damage. Clean up spills immediately.



Caution: Be careful not to tip the machine when rolling over uneven surfaces. Push the machine from the middle when moving it.



Caution: Do not squeeze the blood pressure cuff when deflating it. Squeezing the blood pressure cuff may damage the machine's internal blood pressure module.



Note: A smoke detector should be properly installed in the room used for dialysis. Follow the manufacturer's instructions. The alarm should be tested according to the manufacturer's instructions. Replace the battery as specified.



Note: You must follow all environmental regulations regarding waste disposal and eventual machine disposal. Contact your clinic for more information. Prior to the disposal of your machine, any possible risk of infection from blood borne pathogens must also be eliminated by appropriate disinfection.



Note: The temperature of the bloodline and the durometer of the tubing affect the ability of the bloodline/blood pump system to prime during setup. Cold tubing may not prime as readily as warm tubing.

Fresenius Medical Care manufactures bloodlines for use with the model 2008K² hemodialysis machine. The performance of bloodlines not manufactured by Fresenius Medical Care cannot be guaranteed by Fresenius Medical Care and are therefore the responsibility of the prescribing physician.



Note: The following materials come into contact with purified water, dialysate, or dialysate concentrate:

Dyflor (PVDF)	Polypropylene 20% glass fiber (PP-GF20)
Ethylene-propylene terpolymer (EPDM)	Radel 10 & 20% glass fiber (PES)
Forafion (PVDF)	Stainless steel (types 300 & 316)
Glass	Silicone (Si)
Lupolen (PE)	Teflon (PTFE)
Makrolon (PC)	Thermocomp (PES)
Polyethersulfone (PES)	Titanium – TiAl 4 V6
Polyphenylene oxide (PPO)	Ultem (PEI)
Polyphenylene oxide 20% glass fiber (PPO-GF20)	Ultradur+ (PBT)
Polypropylene (PP)	Victrex (PEEK)
	Vinyl chloride polymer (PVC)

Using a Central Venous Catheter

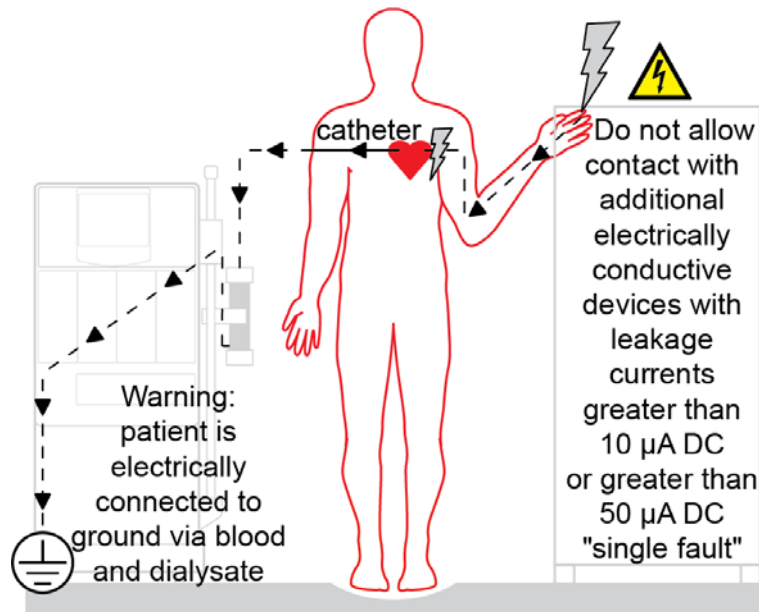

Shock Hazard: Ensure that no conductive electrical devices connected to or near the patient have leakage currents above the maximum CF applied parts limit of 10 µA DC and 50 µA DC in a single fault condition. Failure to follow these precautions may result in serious injury or death.

Maintenance

Assembly, installation, adjustment, or repair is to be performed only by persons authorized by the facility medical director or by Fresenius USA, Inc.

Questions?

For further information regarding the operation, repair, parts, or maintenance of the 2008K² hemodialysis machine, please contact:

Fresenius USA, Inc.

(800) 227-2572

Attention: Service Department
4040 Nelson Avenue
Concord, CA 94520
www.FMCNA.com

This page intentionally blank

Chapter 1

Overview

The 2008K² hemodialysis machine is designed to perform hemodialysis in hospitals and dialysis clinics. It can be used for patients suffering chronic or acute renal failure.

Function of the 2008K² Hemodialysis Machine

The 2008K² hemodialysis machine is designed to provide hemodialysis treatment by controlling and monitoring both the dialysate and extracorporeal blood circuits.

In the extracorporeal blood circuit, the blood is continuously circulated from the patient through a dialyzer, where toxins are filtered out through a semi-permeable membrane, before being returned to the patient. During this process, the extracorporeal blood circuit is monitored for venous and arterial blood pressures, and for the presence of air and blood. The 2008K² hemodialysis machine can also administer heparin evenly throughout the treatment.

In the dialysate circuit, the dialysate concentrates are mixed with purified water, heated, degassed, and delivered to the dialyzer. Balancing chambers ensure that the incoming flow of the dialysate is volumetrically equal to the outgoing flow in order to control ultrafiltration from the patient.

Organization of the 2008K² Hemodialysis Machine

The 2008K² hemodialysis machine is designed for functional efficiency. The back of the machine houses the utility connections such as water source, drain, and electrical connections. By mounting them to the back, the water lines and power cord remain out of the way during treatment.

The front of the machine contains all of the controls the operator needs access to during hemodialysis. It can be broken down into three main sections. The top section contains the control panel and houses the computer that runs the treatment program. The middle section contains the modules used for the safe transmission of the blood to and from the dialyzer. Dialysate is the primary concern of the bottom section of the 2008K² hemodialysis machine. Here the concentrates used to make up the dialysate are mixed and pumped to the dialyzer.

The following pages contain front and rear views of the 2008K² hemodialysis machine and a brief description of the machine's features. You should familiarize yourself with the location and purpose of these features.

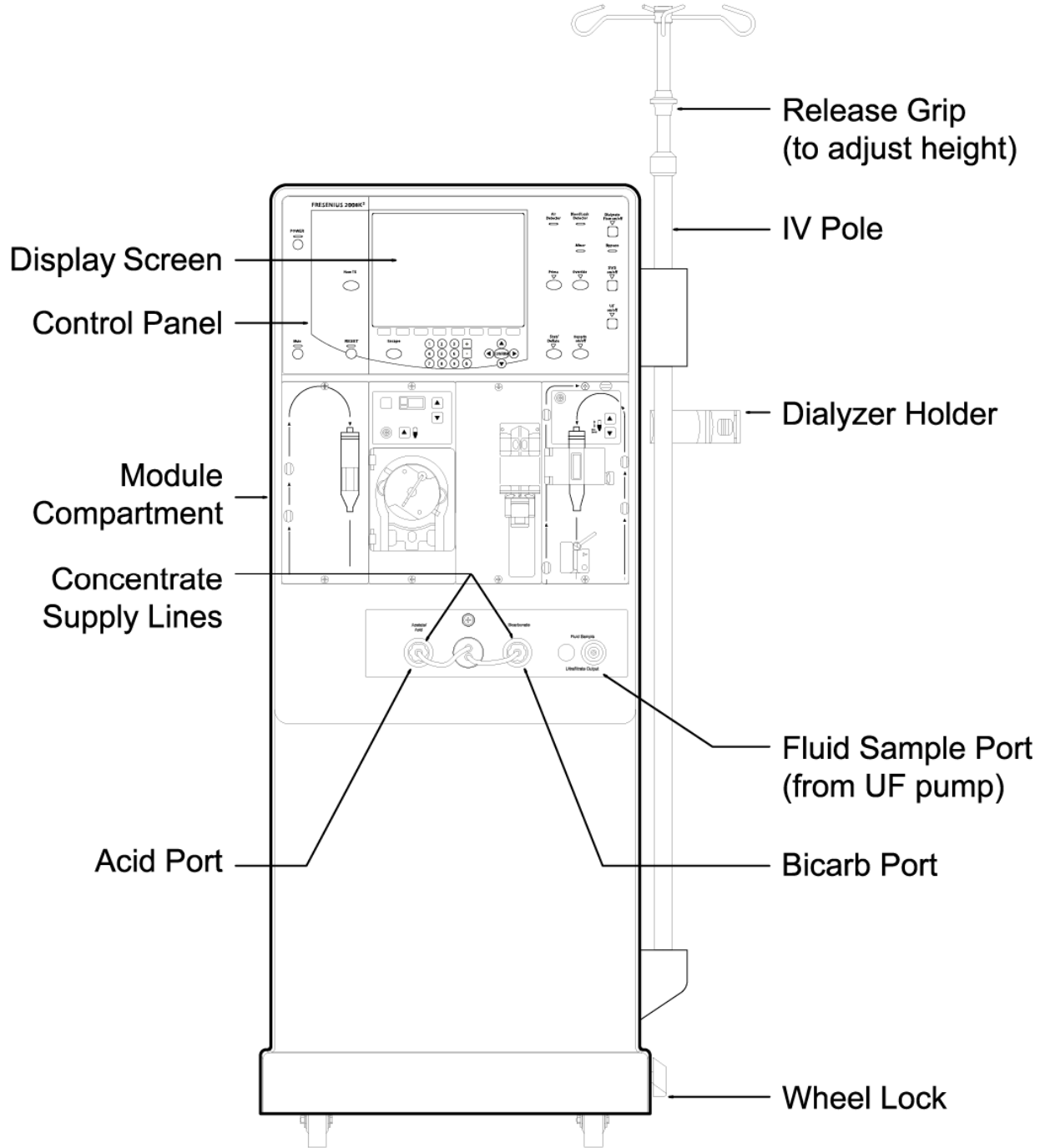

Figure 1 – 2008K² Hemodialysis Machine—Front View

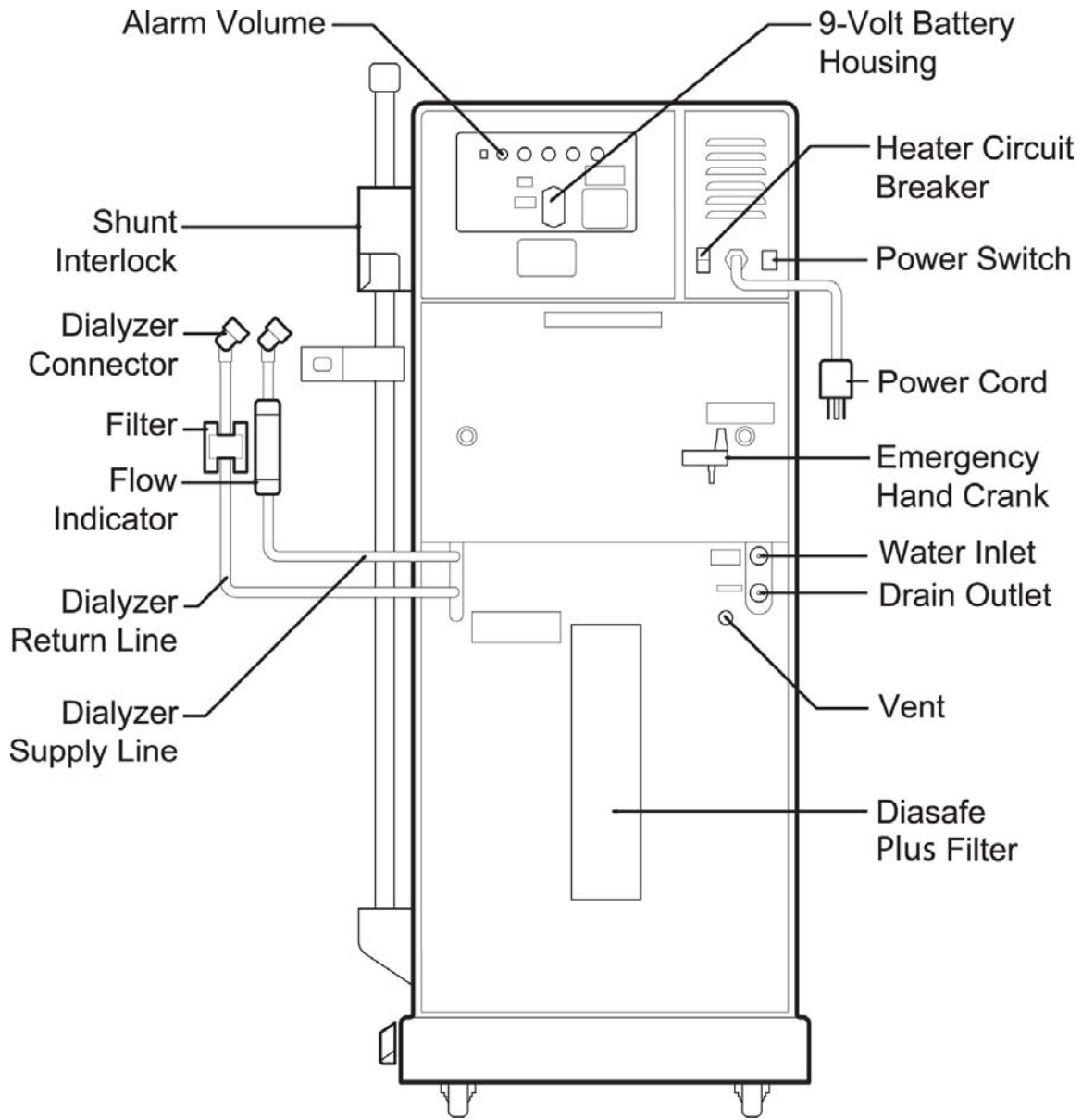

Figure 2 – 2008K² Hemodialysis Machine—Rear View

The Control Panel

The control panel (see Figure 3) is located at the top, front of the 2008K² hemodialysis machine and contains keypads that allow the user to control the operation of the 2008K² hemodialysis machine. Located in the middle of the control panel is the treatment display section that can show a variety of treatment screens which the operator uses to set treatment parameters and monitor the treatment.

The treatment display section provides a means of setting the treatment parameters and monitoring the treatment and patient status during dialysis. The operator can access treatment screens, select the Tx Clock, and set treatment parameters by selecting specific, identified sites (buttons) on the screen. Most numbers and parameters selected on the display screen must then be confirmed by pressing the **CONFIRM** key on the control panel.

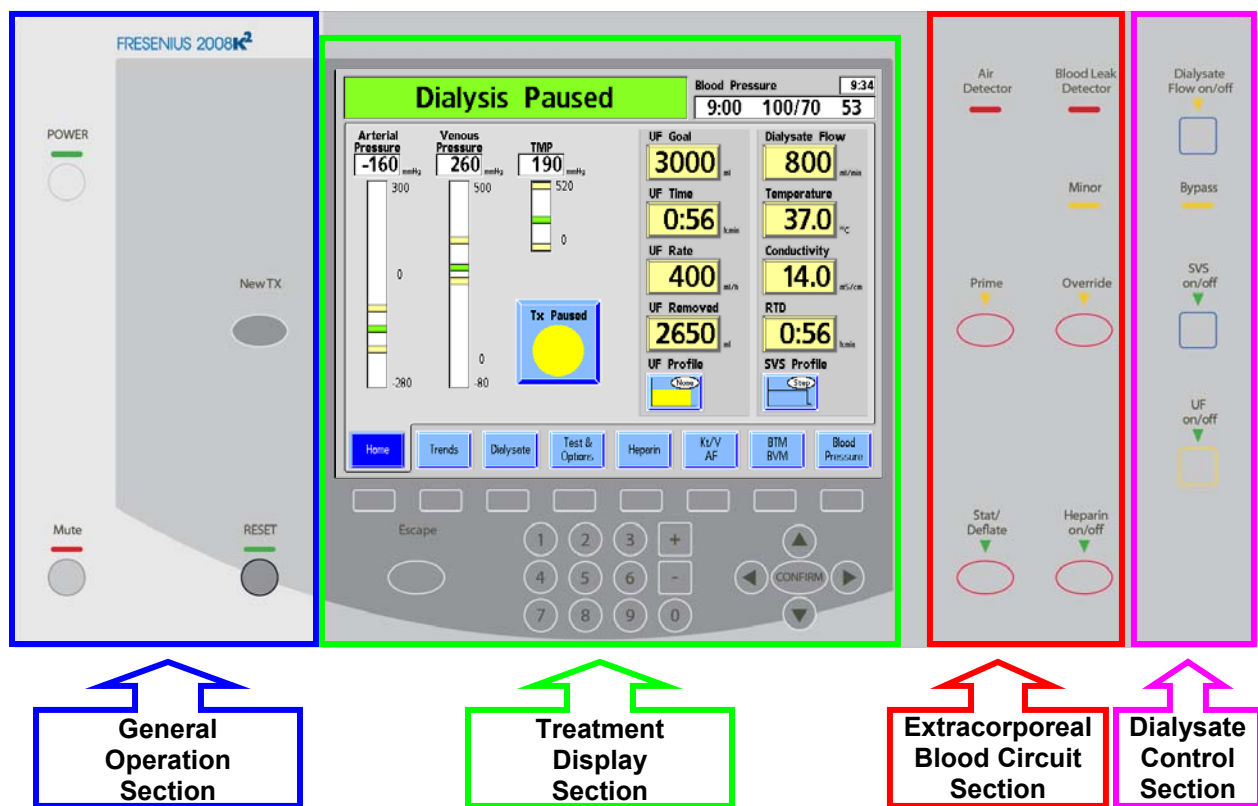

Figure 3 – The Components of the Control Panel

Control Panel Keys

Keys with related functions are grouped into sections on the control panel. The control panel is made up of four sections (see Figure 3). These sections are described in the following pages along with the functions of the keys associated with each.



Caution: Use a finger to press the keys. Use of objects to press the keys may result in damage or premature failure.

General Operation Section

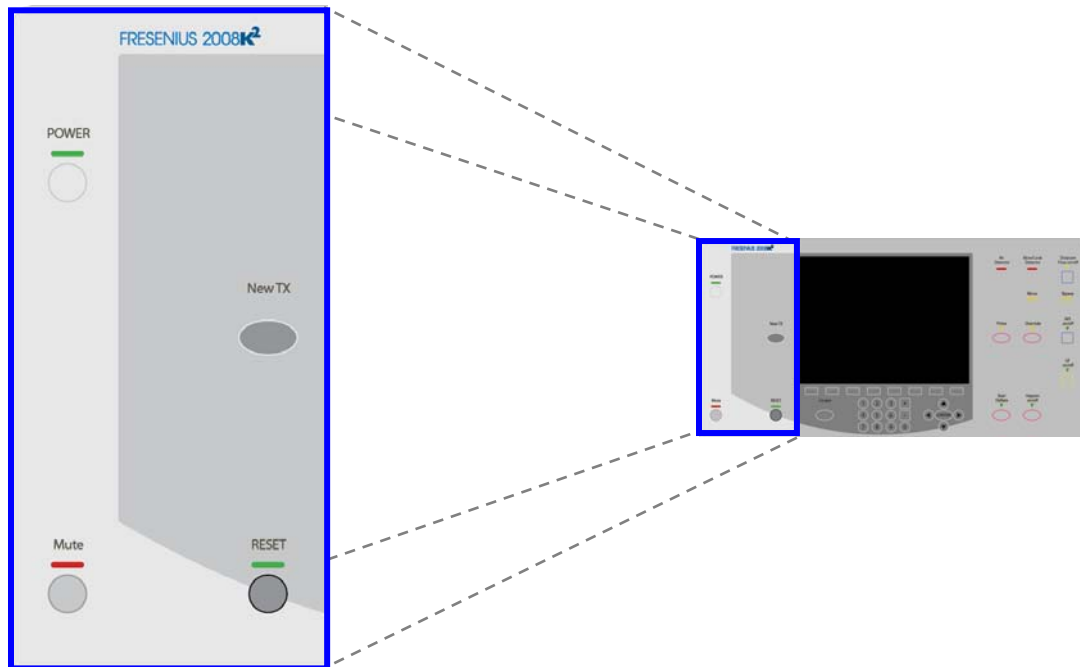





Figure 4 – General Operation Section

The General Operation panel contains four keys associated with starting or stopping the basic power and alarm aspects of any dialysis treatment. The table below lists each key and its function.

Table 1 – General Operation Section Keys

Press ...	To ...
	Turn the machine on. Hold for one second to turn the power off and If blood is sensed, the machine will power down with an audible alarm.

Press ...	To ...
	Silence an alarm for two minutes or until another alarm occurs.
	(New Treatment) Erase the current treatment information and move the summary information to the previous record in the “Trends” screen. Press the CONFIRM key to complete the action. To cancel, press the Escape key.
	Reset the alarms. Press again and hold for one second to set new arterial and venous pressures.

Treatment Display Section

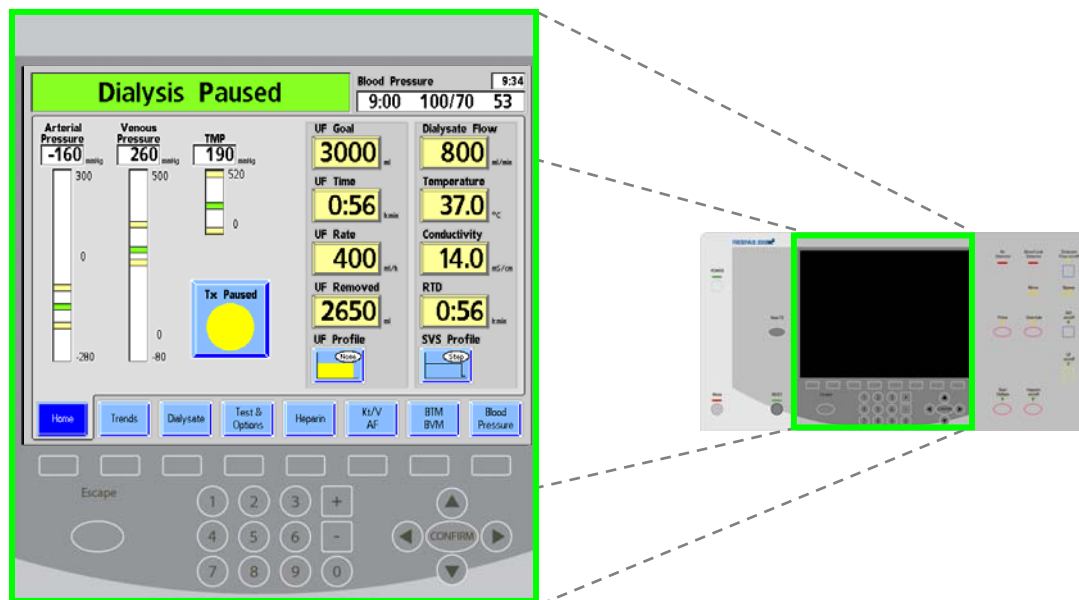

Figure 5 – Treatment Display Section

The Treatment Display section is used to access and set all treatment parameters. It is organized into three subsections: the treatment display screen, the screen access buttons, and the data entry keys (see Figure 6). The treatment screen display contains the area for viewing the various treatment screens. The screen-keys below the display area are used to access the various treatment screens. The data entry keys, at the bottom of the treatment display section, are used to enter treatment parameter values or make selections inside the treatment screen.

The Status Box appears at the top left corner of every treatment screen. During normal operation it displays the operational mode of the machine: Dialysis or SLED. During alarm situations, it displays an informational message. It may also prompt the operator for a specific action in situations when the treatment parameters are being set.

To the right of the Status Box is the Dialogue Box. During normal treatment, the Dialogue Box displays the current time, the time of the last blood pressure reading and the patient's blood pressure and pulse rate at that time.

When attempting to enter a treatment parameter that is outside the range of allowable limits, the Dialogue Box displays an advisory message.

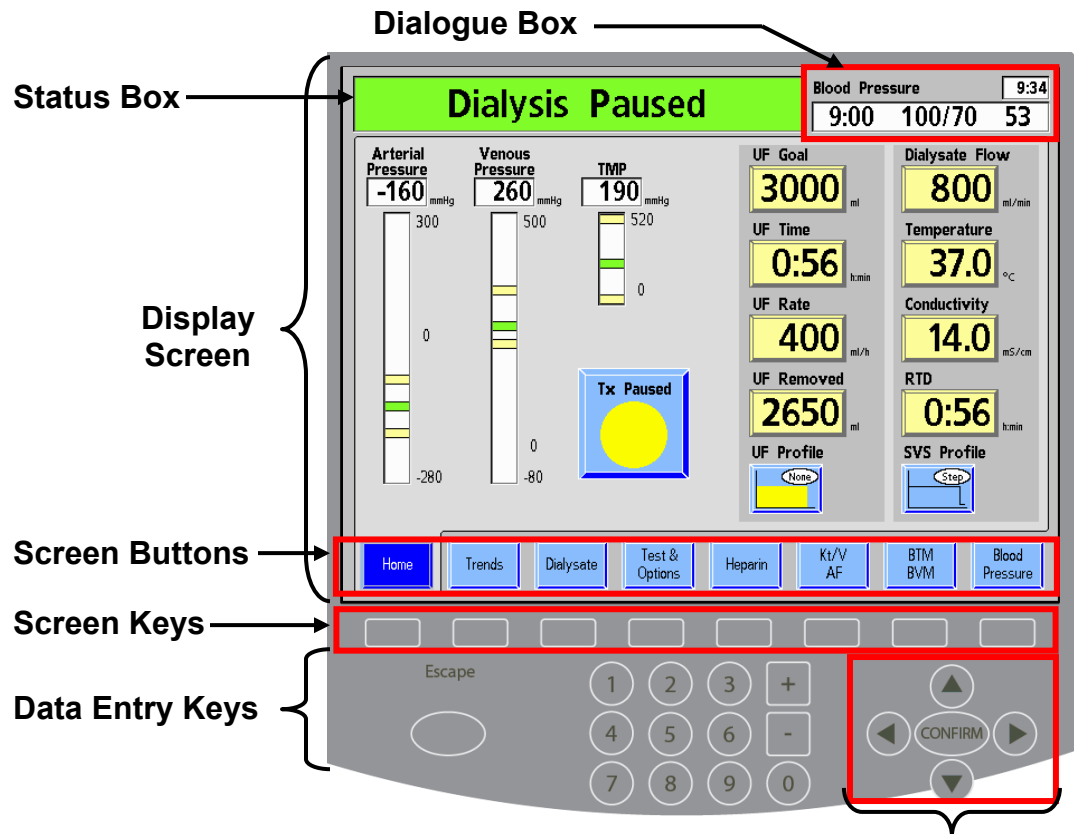

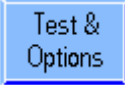
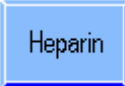











Figure 6 – Control Panel – Treatment Display Section

Navigation Keypad

Table 2 – Treatment Display Keys

Select ...	To ...
	View current treatment data including treatment time remaining, UF data, arterial, venous, and transmembrane pressures, and dialysate data.
	View charts that provide graphic views of treatment effectiveness (Kt/V), sodium variation system (SVS) and ultrafiltration (UF) profiles, and patient's blood pressure over time. Displays the summary data of the patient's treatment progress.

Select ...	To ...
	View and select acid/bicarbonate concentrate type, bicarbonate, sodium, electrolyte concentrations, and conductivity settings.
	View Pressure test, Alarm test, and Diasafe test options and results. View treatment options for low volume and single needle patients, high flux dialyzers, patient ID numbers, and dialysate sampling.
	View options for administering heparin gradually over the course of the treatment or as a bolus injection.
	View estimate of treatment effectiveness based on the actual dialyzer clearance. View the Access Flow messages and data
	View arterial and venous blood temperature data with machines equipped with the optional Blood Temperature Module. For more information, see Blood Temperature Monitor Operating Instructions (P/N 470164). View the relative blood volume data and trends with machines equipped with the optional Blood Volume Module. For more information, see Blood Volume Monitor Operating Instructions (P/N 490041).
	View all pulse and blood pressure test results taken during treatment. Blood pressure alarm limits and inflation pressure and frequency of blood pressure tests are set in this screen.
	View the corresponding screen-button directly above the pressed screen-key.
	Enter numerical values when setting parameters for such treatment options as ultrafiltration rate, times, goal, and volumes.
	Scroll up or down a list of parameter choices or to increase + (plus) or decrease - (minus) parameter values. To speed up the rate at which the value changes, press and hold the key down.
	(Round arrow keys centered on CONFIRM key) Move between buttons on the display screen. Selected parameter buttons are bright yellow, selected screen/toggle/action buttons are dark blue. Pressing a round arrow key once will show which button is selected. After selecting a toggle-button, pressing the left or right keys and pressing CONFIRM will change the button's setting.
	Save a treatment parameter entry or confirm an action initiated on the display screen. The CONFIRM key is a backup, safety feature designed to prevent accidental changes to the intended treatment parameters.
	Void the current entry and return to previously entered parameter value before CONFIRM is pressed.

Specific information regarding each treatment screen can be found in Chapter 3, “Setting Treatment Parameters” and Chapter 4, “Monitoring the Treatment.”

Blood Circuit Section

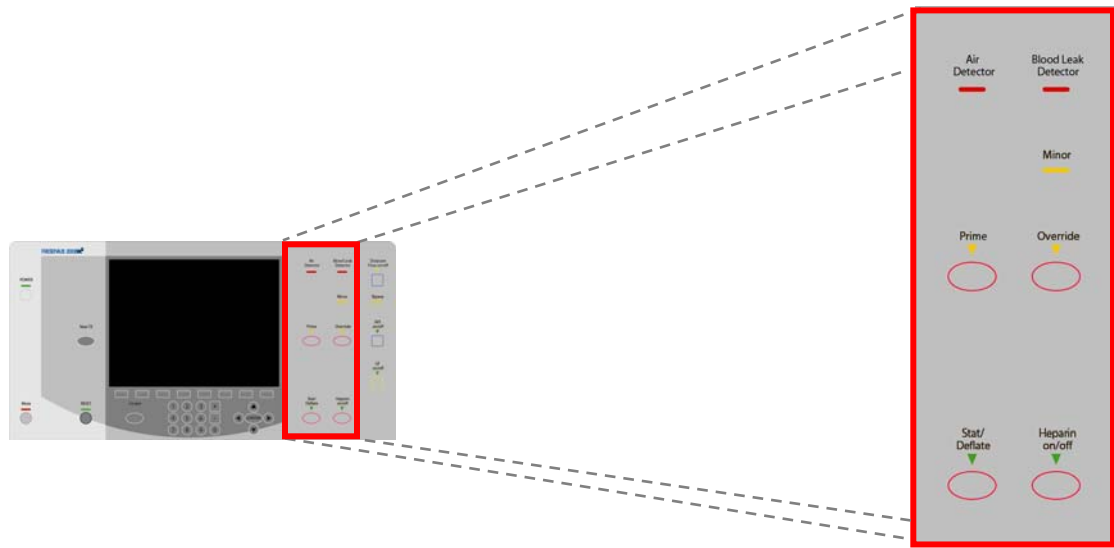







Figure 7 – Blood Circuit Section

The Blood Circuit section contains keys and warning lights that are directly related to the transmission and monitoring of the patient’s blood. These keys are outlined in red on the control panel.



Table 3 – Blood Circuit Section Keys

Press ...	To ...
	<p>Keep the blood pump running for three minutes when a blood-leak alarm is present. The yellow Override light will illuminate.</p> <p style="text-align: center;">OR</p> <p>If a blood leak alarm is not present, pressing and holding the Override key for one second will spread the arterial and venous alarm limits 300 mmHg and the TMP alarm limits are spread fully open for 30 seconds. The Override light will not illuminate.</p>
	<p> Warning! During an override, the blood leak detector is inactive. Monitor the treatment.</p>

Press ...	To ...
	<p>Prime the extracorporeal blood circuit. Pressing Prime will keep the blood pump running when air is sensed in the venous blood chamber and a level detector alarm is present (as is the case during initial set up when the blood circuit tubing is empty). The pump will run for:</p> <p>Two minutes, or</p> <p>Until an adequate fluid level is detected by the ultrasonic sensors in the level detector module, or</p> <p>Until the volume set in Service Mode is reached.</p>
	<p>Start an unscheduled, manual blood pressure measurement when the cuff is deflated, or instantly deflate the inflated blood pressure cuff.</p> <p> Note: Certain versions of the blood pressure module require a 30 second delay between blood pressure measurements.</p>
	<p>Turn the heparin pump on or off. When the heparin pump is on, the green, triangular light is illuminated. This light will flash when heparin pump is interrupted.</p>

In the event of a blood leak or the detection of air in the extracorporeal blood circuit, the blood warning lights illuminate and are accompanied by an audible alarm. For detailed descriptions and instructions regarding remedial actions, see chapter 6, “Alarms and Troubleshooting.”

Table 4 – Blood Circuit Section Warning Lights

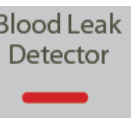
Indicator Light	Situation
	The fluid level has dropped below the sensors in the venous drip chamber.
	A minor blood leak has been detected by the blood leak detector.
	An amount of blood greater than 0.45 ml/min has been detected in the dialysate by the blood leak detector.

Dialysate Control Section

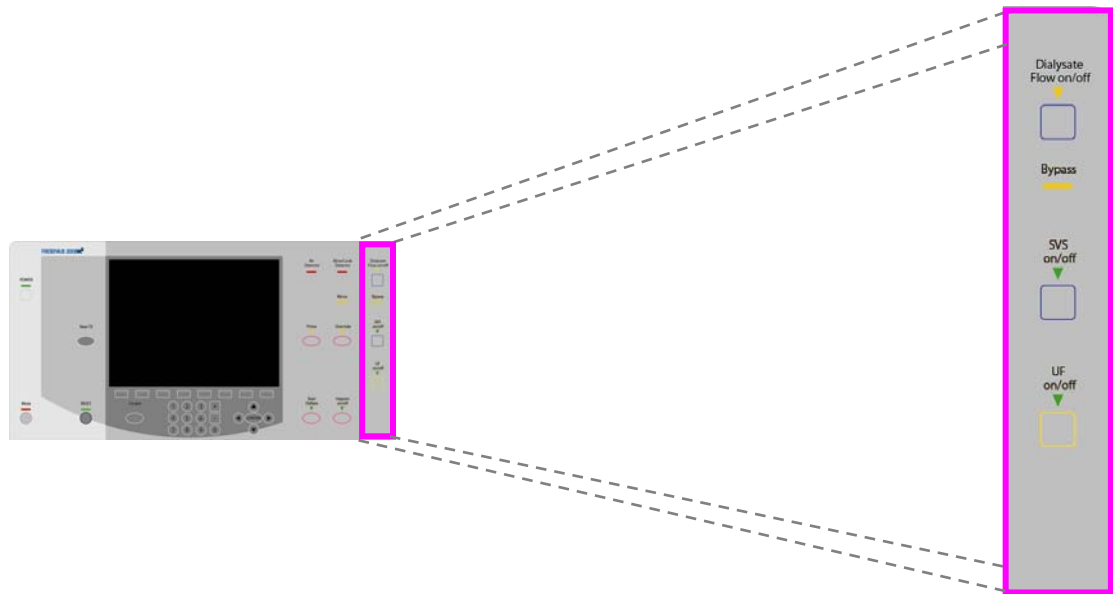







Figure 8 – Dialysate Control Section

The Dialysate Control section contains the keys required to start and stop the flow of dialysate, the Sodium Variation System (SVS), and ultrafiltration.

Table 5 – Dialysate Control Section Keys

Press ...	To ...
	Start and stop the flow of dialysate. Flow is off when the yellow, triangular light is solid or flashing. The light is not illuminated when flow is on.
	Activate the Sodium Variation System (SVS) program. When the SVS is on, the green, triangular light is illuminated. This light will flash when SVS program is interrupted. If the SVS option is set to 'No' in Service Mode, the Sodium Variation System is not available.
	Turn the ultrafiltration pump on or off. During ultrafiltration, the green light is illuminated. This light will flash when ultrafiltration is interrupted.
	 Note: When the UF pump is turned off, there is no “minimum” ultrafiltration occurring.
	Dialysate flow is bypassing the dialyzer because dialysate is outside the allowable temperature or conductivity limits, or shunt interlock door is open.

Modules

The modules accompanying the 2008K² hemodialysis machine are located just below the control panel. The Arterial Drip Chamber, Blood Pump, Heparin Pump, and Level Detector modules contribute to the task of transmitting the blood from the patient, through the dialyzer and back to the patient. The red lines on the modules are guides for the arterial bloodline (from patient to the dialyzer). The blue lines are guides for the venous bloodline (from dialyzer to patient).

Any machine can be set up for a pre-pump or post-pump arterial chamber, or single-needle dialysis (requiring two blood pumps) by adding modules, or rearranging their order.

The preferred arrangements, shown in Figure 21 and Figure 22 on page 46, can help to simplify the routing of the blood tubing and minimize the possibility of kinking the bloodline.

Additionally, the internal blood pressure module is explained on page 36.

The Arterial Drip Chamber Module

The arterial drip chamber module is a panel with guides for blood tubing and a holder for the arterial drip chamber. The button used to raise the arterial drip chamber level is located on the Blood Pump module.

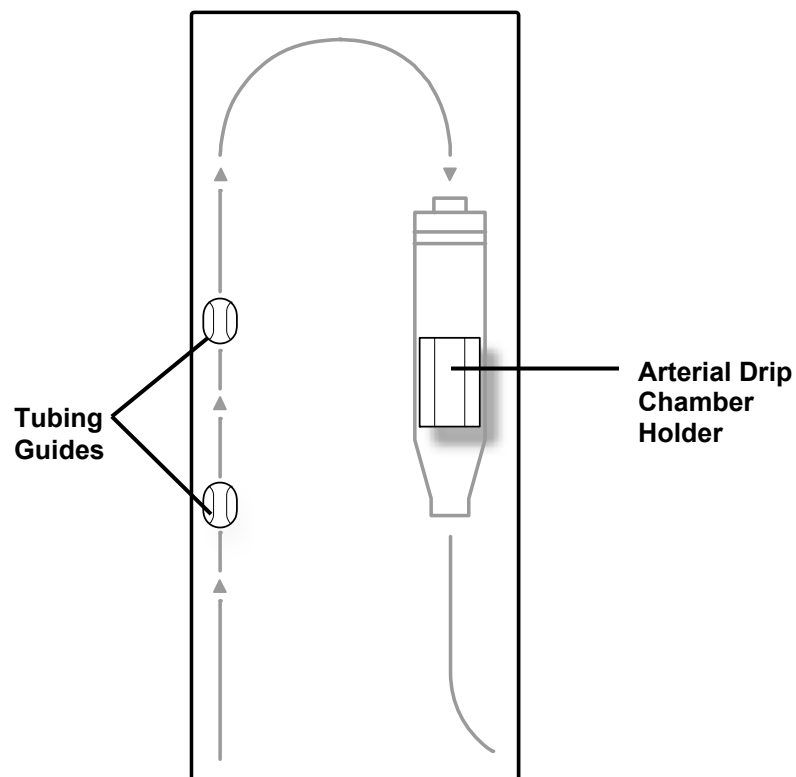

Figure 9 – The Arterial Drip Chamber Module

The Blood Pump Module

The blood pump draws blood from the patient and pumps it to the dialyzer and back to the patient in a closed circuit. To accomplish this, the pump segment of the blood tubing is threaded through the pump housing along a circular track. As the pump rotor rotates, twin rollers squeeze the pump segment, pulling and pushing the blood through the blood pump segment. The speed of the pump can be adjusted using the arrow keys on the blood pump. The blood pump can be stopped by pressing the **Start/Stop** key or by opening the blood pump door. When the door is open, the diameter of the pump segment is shown in the display window.

Pressing the single ▲ key on the Blood Pump module activates a small pump that raises the fluid level in the arterial chamber. This ▲ key (level adjust) can be used only to raise the level of fluid in the chamber, and cannot be used to lower it. This is to avoid introducing air into the blood flow.



Warning! The ▲ key (level adjust) on the Blood Pump module can only be used to raise the level in the arterial chamber. Do not press the level adjust key so long that the pressure transducer protector becomes wet. Wet transducer protectors must be replaced to avoid erroneous pressure readings.



Note: A separate hand crank is supplied with the pump at the back of the machine that can be used to return the blood to the patient in case of a power failure.

Note: The 2008K² hemodialysis machine's modules and internal hydraulics involve fluids: accidental spills can occur. Spills may cause slips and falls and can cause damage to carpeting and other surfaces. To contain such spills, the machine should be on a spill-tolerant surface. Clean up spills immediately.

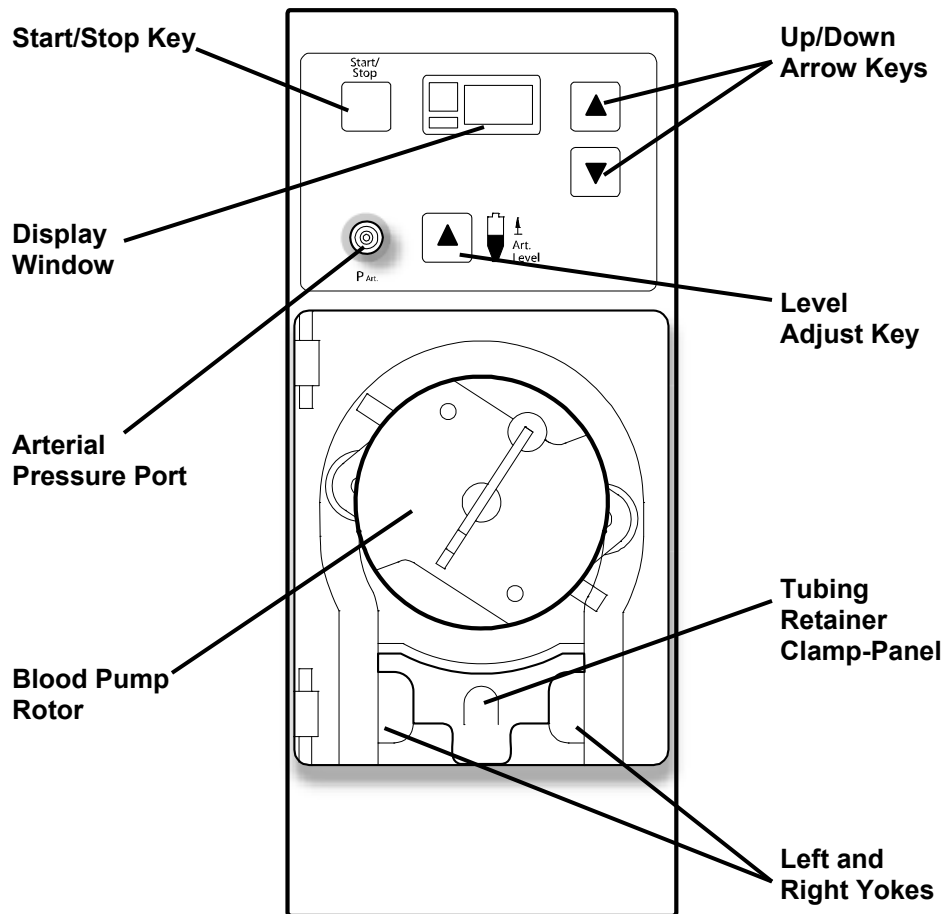

Figure 10 – The Blood Pump Module

The following table describes the operational features of the blood pump.

Table 6 – Blood Pump Features

FEATURE	PURPOSE
Start/Stop Key	Starts and stops the blood pump. Opening the door will also stop the blood pump.
Pressure Port	Line from arterial drip chamber is connected to a transducer protector and attached here to provide arterial blood pressure readings.
Level Adjust Key	Pressing the ▲ key (level adjust key on the Blood Pump module) will raise the level of the fluid in the arterial drip chamber.
Display Window	Displays the blood flow rate setting in increments of 5 ml/min during blood pump operation. When the door is open it displays the pump-segment diameter in mm.
Up/Down Keys	Increases the speed of the pump when Up arrow (▲) is depressed, decreases the pump speed when Down arrow (▼) is depressed. When door is open, simultaneously press the ▼ and ▲ keys and then press the ▼ or ▲ key to select the pump segment diameter.
Tubing Retainer	A spring-loaded device that secures the pump segment in place.

The Heparin Pump Module

The heparin pump provides a means of injecting heparin into the blood circuit gradually over the course of the treatment and/or as a bolus. The pump can accommodate a variety of syringes that are commercially available. The pump works in conjunction with the “Heparin” screen where such parameters as the size and type of the syringe, infusion rate, infusion time, and bolus amount of heparin to be infused are selected.

If heparin is infused manually (by pushing in the carriage lock button while pushing on the slide carriage), the volume will not be added to the displayed amount, and must be added to the total heparin amount. Manually moving the carriage to infuse heparin is not recommended.

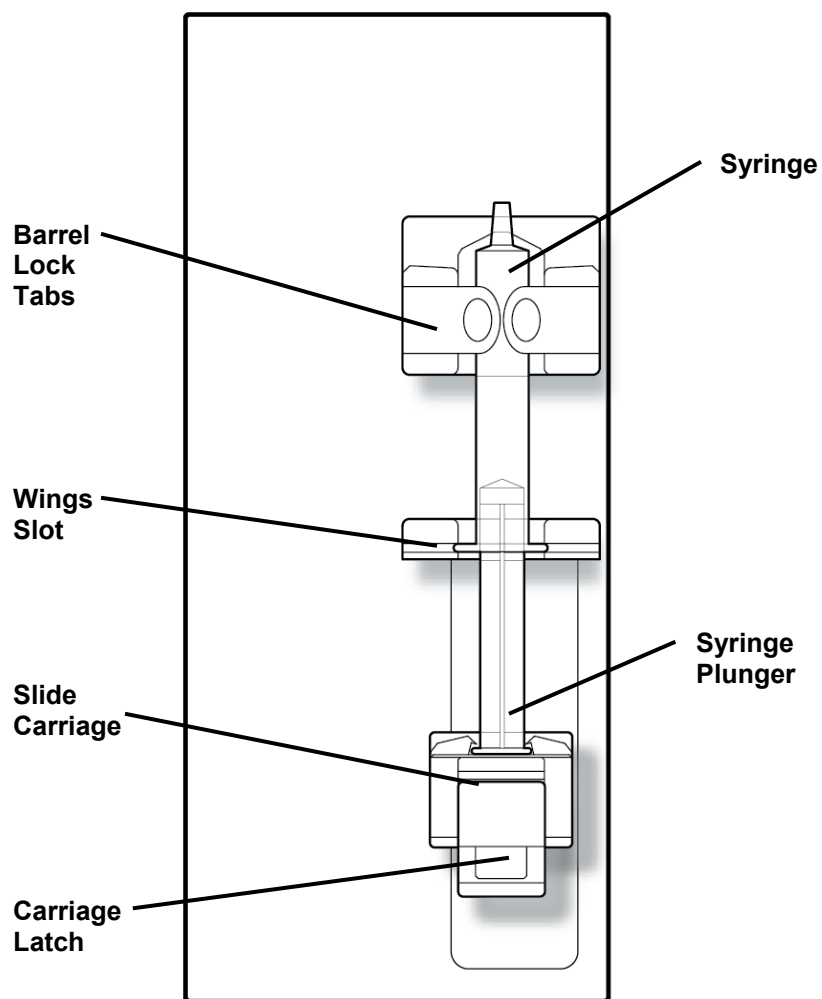

Figure 11 – The Heparin Pump Module (shown with syringe)

The Level Detector Module

The Level Detector module is used to monitor the level of fluid in the venous drip chamber. The venous drip chamber is mounted inside its holder and the blood tubing leading back to the patient is threaded through the venous line clamp below it. An ultrasonic device inside the chamber holder monitors the drip chamber for the presence of air. If the level of blood in the chamber is too low and air is detected, the machine alarms, the blood pumps stops, and the clamp occludes the venous blood tubing.

An optical sensor located below the occlusion clamp recognizes whether or not blood, an opaque fluid, is detected in the venous line. When the dialysate supply lines are on the shunt, and the shunt door is closed, and blood is not sensed, the audible alarm is suppressed entirely.

Also located on the front of the module is a pressure port. The small monitor line from the drip chamber is connected to the transducer port. The pressure of the venous side of the blood circuit is read by the transducer mounted on the inside of the module, and the pressure is displayed in the “Home” screen.

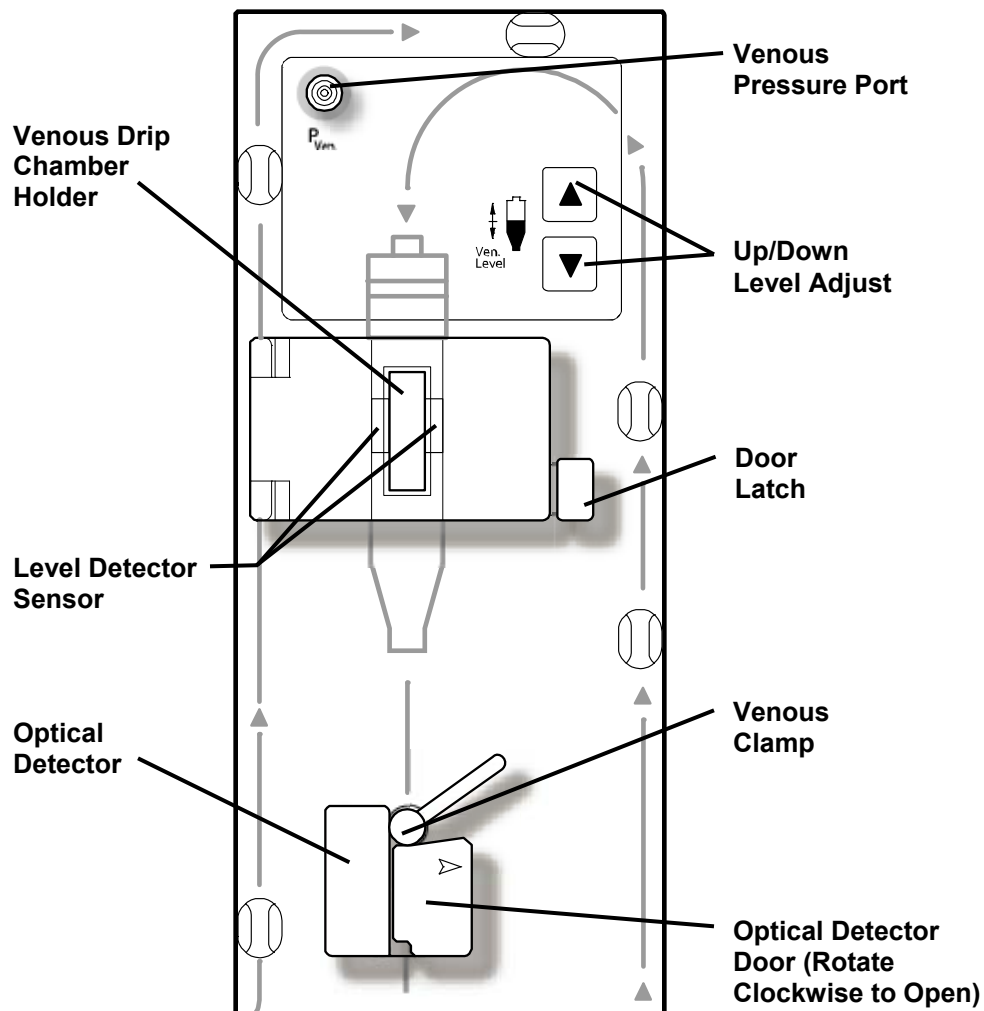

Figure 12 – The Level Detector Module

Table 7 – Level Detector Features

FEATURE	PURPOSE
Venous Pressure port (P _{Ven.})	Line from venous drip chamber is connected to a transducer protector and attached here to provide venous blood pressure readings.
Venous Drip Chamber Holder	Holds the drip chamber and aligns it with the ultrasonic air sensor. Latching door secures chamber in place.
Level Adjust Keys	Raises the level of the fluid in the chamber when the ▲ (up arrow) key is pressed, and lowers the level when ▼ (down arrow) key on the level detector is pressed.
Optical Detector	Secures venous blood tubing leading back to the patient and houses venous line clamp and optical detector. The optical detector distinguishes between opaque fluid (blood) and a transparent medium such as saline.
Venous Line Clamp	Automatically occludes the blood tubing leading back to the patient during blood-alarm situations.

Blood Tubing System

The dialysate delivery machine can be used with a variety of blood-tubing configurations. The modules (Arterial Drip Chamber, Blood Pump, Level Detector, and Heparin Pump) can be arranged on the 2008K² hemodialysis machine in a variety of ways to allow for pre- or post-arterial pump pressure monitoring. The machine can accommodate most standard blood tubing that have pump segments ranging from 2 to 10 mm internal diameter. An additional single needle blood pump and special arterial line with two pump segments and a compliance chamber is required on a machine set up for single-needle dialysis.

The Blood Pressure Module

The Blood Pressure module is located internally with the pressure tubing running from the back of the machine to the cuff. The module can automatically take the patient's blood pressure at defined intervals, record the systolic, diastolic, MAP, and pulse values, and plot out the results on both the "Blood Pressure" screen and the "Trends" screen. The pressure cuffs come in a variety of sizes to accommodate low volume through large adult patients. The Adult size comes standard with the 2008K² hemodialysis machine and can accommodate patients with upper arm circumferences of 25-35 centimeters. An optional thigh cuff is also available.

The Dialysate Path

The 2008K² hemodialysis machine is a three-stream dialysate delivery machine: it mixes the dialysate from three different sources and sends it to the dialyzer for treatment. The three main parts of the dialysate are: purified (RO) water, acid concentrate, and bicarbonate concentrate. After the machine heats and degasses the water, it mixes in the concentrates to form dialysate. The machine then filters the dialysate with the Diasafe Plus filter (see page 187). The ultra-pure dialysate pumps through dialysate lines to the ports on the side of the dialyzer. Meanwhile, the blood pumps through the bloodlines connected at each end of the dialyzer. The blood and dialysate meet in the dialyzer but never touch. The dialysate pulls waste from the patient's bloodstream and then washes it out the drain. The Balancing Chamber makes sure that the incoming flow of the dialysate is equal to the volume of the outgoing flow to control ultrafiltration from the patient's body. Ultrafiltration (UF) is the process of removing excess fluid during the treatment. The fluid that is removed is called UF Removed and the value is displayed on the machine's "Home" screen.

The Dialysate Section

The Dialysate Section contains connectors for acid and bicarbonate concentrates.

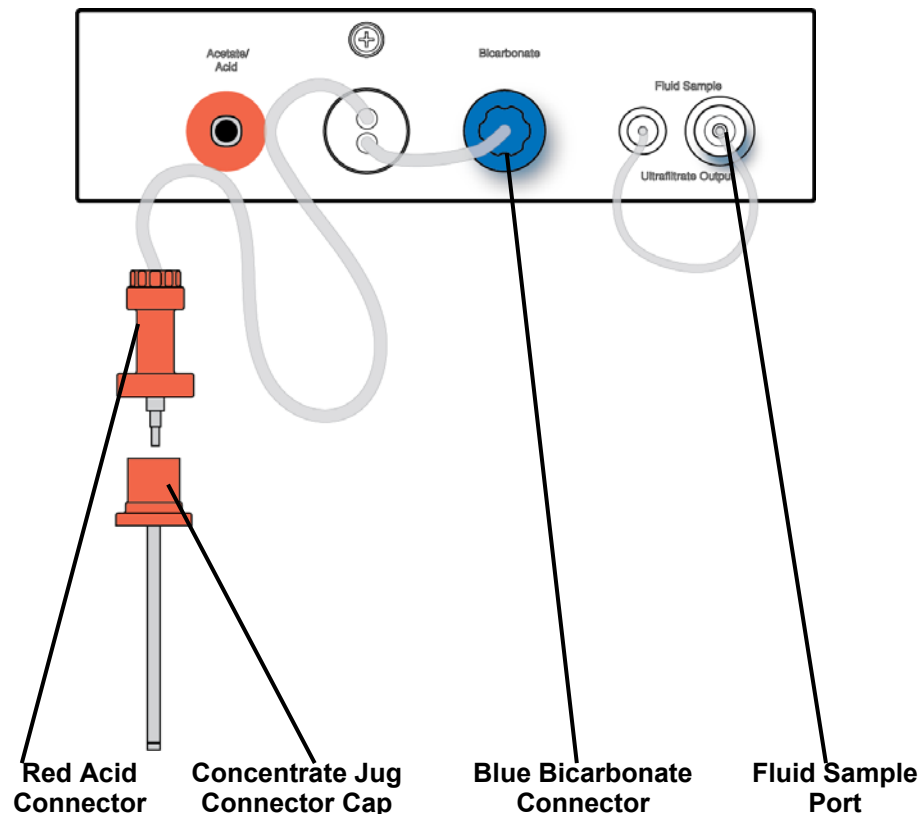

Figure 13 – The Dialysate Section

Table 8 – Dialysate Section Features

FEATURE	PURPOSE
Red acid and blue bicarbonate connectors	The concentrate connectors draw in acid and bicarbonate concentrates. The concentrate connectors pull out and connect to jugs of acid and bicarbonate concentrates or a concentrate central feed. When connecting, make certain to correctly match red to acid and blue to bicarbonate concentrates.
Concentrate Jug Connector Cap	The connector cap snaps onto the top of concentrate jugs. The Acid and Bicarbonate connectors connect to the cap so the machine can pull concentrate from the jugs.
Fluid Sample Port	The Fluid Sample Port allows testing of the UF pump.

The Shunt Interlock

The shunt interlock is located on the right side of the 2008K² hemodialysis machine. It links the dialysate lines when they are connected to it.

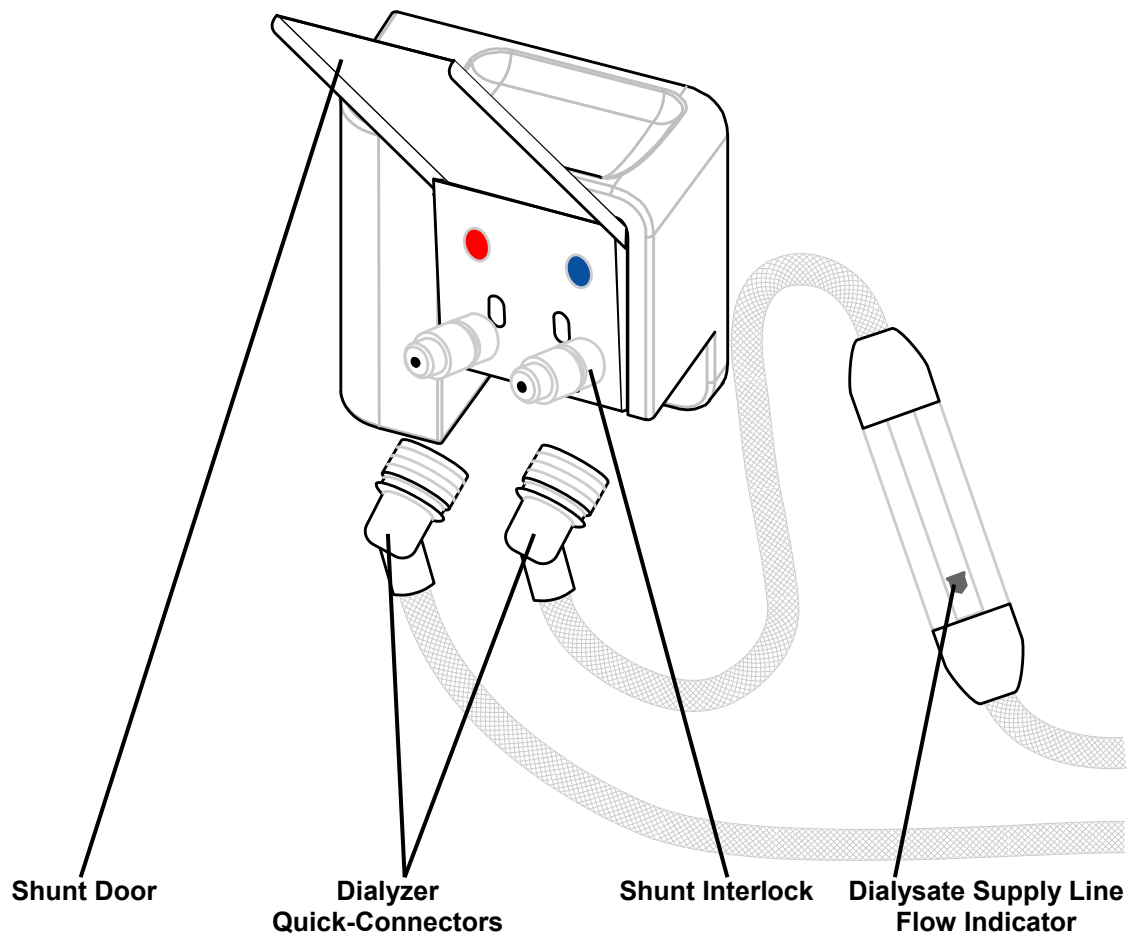
**Figure 14 – Shunt Interlock, Flow Indicator & Dialyzer Connectors**

The shunt door flips up to reveal color-coded quick-connectors. Push quick-connectors onto the shunt interlock and the dialyzer ports to snap them in place. After making a connection, pull on the connector to make sure it fits tightly. When disconnecting: slide the metal collar back on the quick-connector to release the connection (see Figure 15 below).

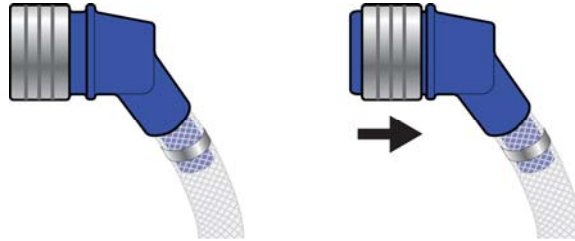

Figure 15 – Removing Dialyzer Quick-Connectors

The dialyzer connectors attach to the dialyzer during dialysis or the shunt interlock during rinse programs. Make certain to correctly match red to red and blue to blue.

The blue dialyzer supply line features a dialysate flow indicator tube. A moving float in the tube allows the operator to see when dialysate is running through the lines and the dialyzer. The float does not move when the machine is in bypass mode. Lifting the shunt door will manually put the machine in bypass mode.

Dialyzer

The 2008K² hemodialysis machine is compatible with commercially available dialyzers that are equipped with standard dialysate connections (ISO 8637).

IV Pole and Dialyzer Holder

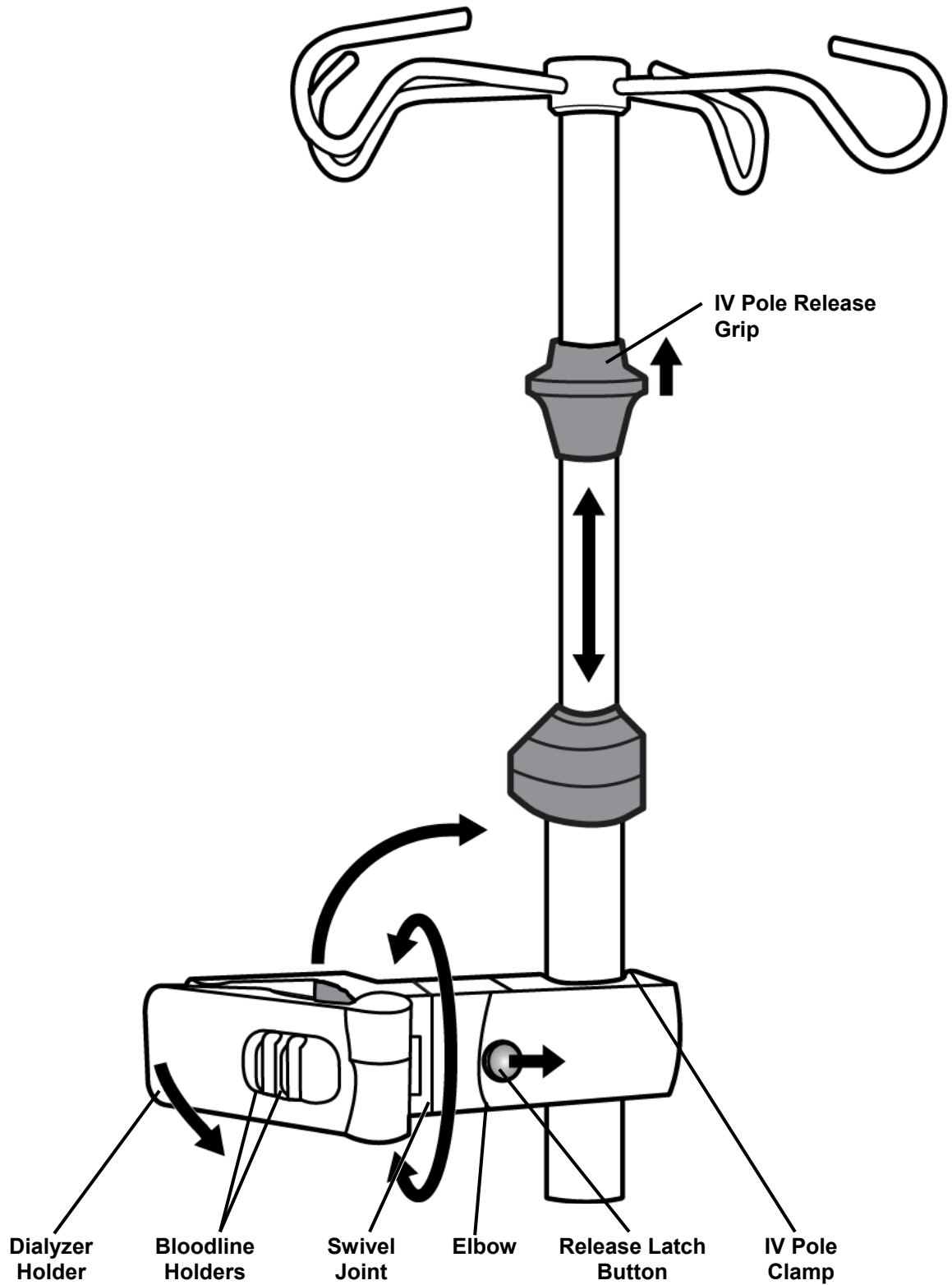

Figure 16 – The IV Pole and Dialyzer Holder

Table 9 – IV Pole and Dialyzer Holder Features

FEATURE	PURPOSE
IV Pole	<p>The IV pole is on the right side of the 2008K² hemodialysis machine. This pole is utilized to hold various medications and solutions that may be required during a treatment.</p> <p>Near the top of the pole is a black release grip that is used to adjust the height of the IV pole. Lift up on the grip to slide the top of the IV pole up or down. Let go of the grip to lock the IV pole at its new height.</p>
Dialyzer Holder	<p>The dialyzer holder keeps the dialyzer in place during the treatment. The end of the dialyzer holder swings shut to clamp around a dialyzer. It rotates at the swivel joint on an arm. This is so the dialyzer can be easily flipped in the holder during treatment setup and end procedures.</p> <p>The opposite end of the arm clamps on the IV pole when the arm is straight. To move the arm up or down along the IV pole: slide the Release Latch Button toward the IV pole and bend the arm upward at the elbow. The arm's IV pole clamp will loosen and then the arm can move freely. To clamp the arm on the IV pole, straighten the arm at the elbow again.</p> <p>The dialyzer holder also has bloodline holders like the tubing guides on the machine's modules. Press the bloodlines into these holders to help keep them visible and free from kinks.</p>

Traffic Light Status Beacon

The traffic light beacon is an optional attachment that enables clinic personnel to determine operational status (normal, warning, and alarm) from a distance. The traffic light is a column that attaches to the top of the IV pole and contains three colored lights. The lights—red, green, or yellow—are used to display status information. This allows clinic personnel to monitor the status of each 2008K² hemodialysis machine from a distance during treatment. There are several selections for meaning of the lights described in the Available Software & Hardware Treatment Options, page 222.

Moving the Machine

The 2008K² hemodialysis machine has wheels on the bottom to make it easy to move. Before moving the machine, make sure the IV pole is secured in its lower mount.

The wheel lock may need to be released before the machine will roll. The wheel lock is on the right side of the 2008K² hemodialysis machine at the base. To unlock the wheels, press down on the front end of the foot pedal. To lock the wheels again, push down on the back end of the foot pedal.

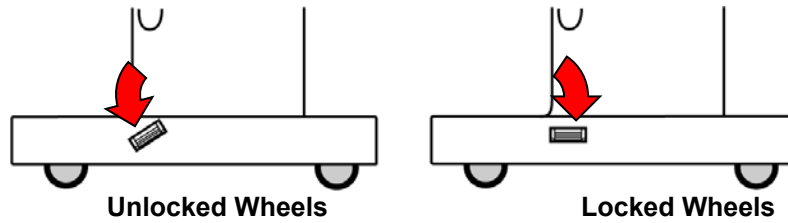

Figure 17 – The Wheel Lock



Warning! Tip Hazard. Do not push or lean against machine when the wheel lock is set.

Warning! Be careful not to tip the machine when rolling it over uneven surfaces. Push the machine from the middle when moving it.

Moving across a level surface

Before moving the machine, properly secure the IV pole to its lower mount. Hold the IV pole below its upper mount as a handle to maintain control of the machine. Push the machine from the middle when moving it.

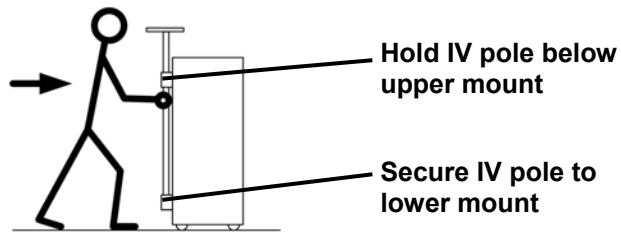

Moving over a ¾ inch threshold

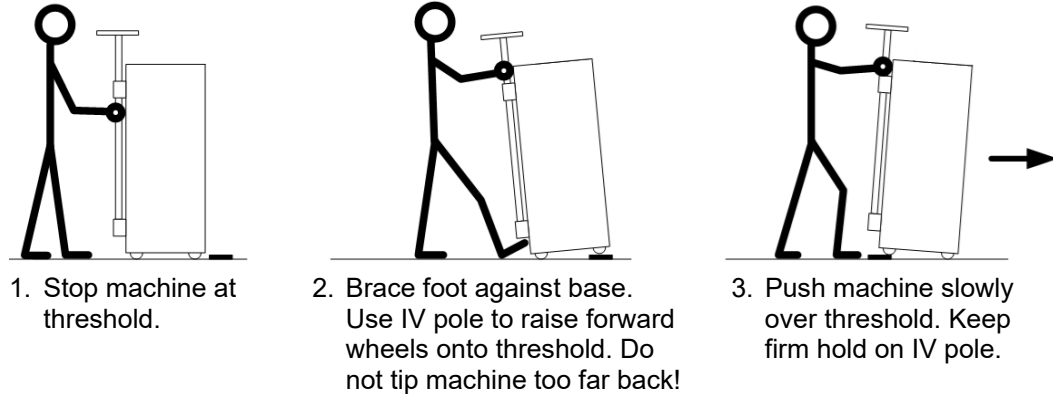

1. Stop machine at threshold.

2. Brace foot against base. Use IV pole to raise forward wheels onto threshold. Do not tip machine too far back!

3. Push machine slowly over threshold. Keep firm hold on IV pole.

Moving down a 1 ½ inch step

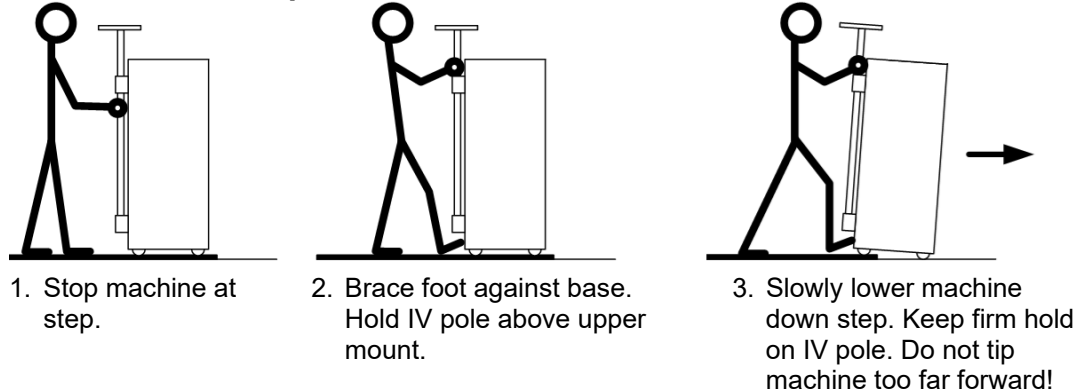

1. Stop machine at step.

2. Brace foot against base. Hold IV pole above upper mount.

3. Slowly lower machine down step. Keep firm hold on IV pole. Do not tip machine too far forward!

Figure 18 – Moving the 2008K² Hemodialysis Machine

Daily Preparation for Treatment

This chapter provides the qualified operator with the recommended daily procedures for preparing the 2008K² hemodialysis machine for regular hemodialysis operation. To prepare the 2008K² hemodialysis machine for Sustained Low Efficiency Dialysis (SLED), see Appendix A.

Covered here are the initial tasks that are to be performed before the patient is connected to the extracorporeal blood circuit. These tasks are not patient-specific, and are broken down into three categories:

- Setting up the dialysis delivery system
- Preparing the extracorporeal blood circuit
- Conducting pressure and alarm tests

Starting Point

The following is a checklist of conditions that should exist after installation of the 2008K² hemodialysis machine by a qualified technician. Before beginning the daily preparation procedures, visually inspect the machine to verify that:

- ✓ The water supply line is connected to the water inlet and the water is turned on.
- ✓ The machine's drain line is inserted into a drain with an air gap.
- ✓ The power cord is plugged into a grounded, GFI-protected wall socket, and the main power switch located on the back of the machine is in the ON position.
- ✓ The heater switch is in the ON position.
- ✓ The acid/acetate suction line (red connector) is inserted into the red, acid/acetate, rinse port.
- ✓ The bicarbonate suction line (blue connector) is inserted into the blue, bicarbonate, rinse port.
- ✓ The dialyzer supply line (blue connector) and dialyzer return line (red connector) are inserted into the matching-color connectors of the shunt interlock.
- ✓ The machine has been recently disinfected and rinsed, and is ready for use.
- ✓ Ensure the emergency hand crank for the blood pump is available.

If any of the conditions listed vary from those found on the machine, correct them before continuing with the daily preparation procedure.

Preparing the Dialysis Delivery System

To prepare the 2008K² hemodialysis machine for operation:

1. Press the **POWER** key on the control panel. The green light above the key will light, and the “Select Program” screen (see Figure 19) will appear on the monitor after approximately one minute.



Note: If the machine is filled with disinfectant or Rinse is the only option that appears in the “Select Program” screen, the machine must complete a rinse cycle before being used for treatment. Select **Rinse** and press the **CONFIRM** key to start the rinse cycle. Upon completion of rinse cycle test the machine for any residual disinfectant according to the established guidelines of the facility.

Note: During the power up sequence a message is displayed for a few seconds: “Press Confirm for Service Mode”. If this is done, the machine enters the calibration screens instead of the “Select Program” screen.

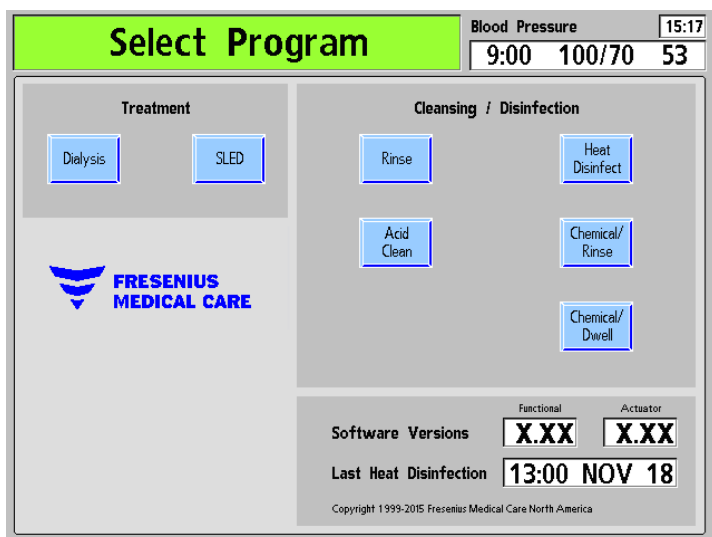

Figure 19 – The Select Program Screen

2. Insert the acid concentrate (red) connector into a centralized acid supply or a jug containing sufficient acid concentrate for an entire treatment. If acetate concentrate is being used, insert the red connector into the acetate supply.



Caution: Be sure the jug contains enough concentrate for the entire treatment. If the jug runs out during treatment, a condition known as “air lock” may occur, causing conductivity problems.

3. If the machine is being prepared for normal dialysis, select the **Dialysis** button on the display screen by pressing the round right arrow on the Navigation Keypad until the **Dialysis** button is selected (dark blue) then press the **CONFIRM** key. The “Dialysate” screen will appear on the monitor (see Figure 20). If the machine is being prepared for Sustained Low Efficiency Dialysis (SLED) therapy, select the **SLED** button instead. For more information on SLED, see the SLED section in Appendix A.

- Verify that the concentrate type, displayed near the top of the screen, correctly matches the prescribed concentrate type, and that the acid/bicarbonate or acetate concentrates connected to the machine match the type selected. If an incorrect concentrate type is displayed, the correct concentrate must be entered. To change the concentrate selection, see “Setting an Acid/Bicarbonate Type” on page 66.

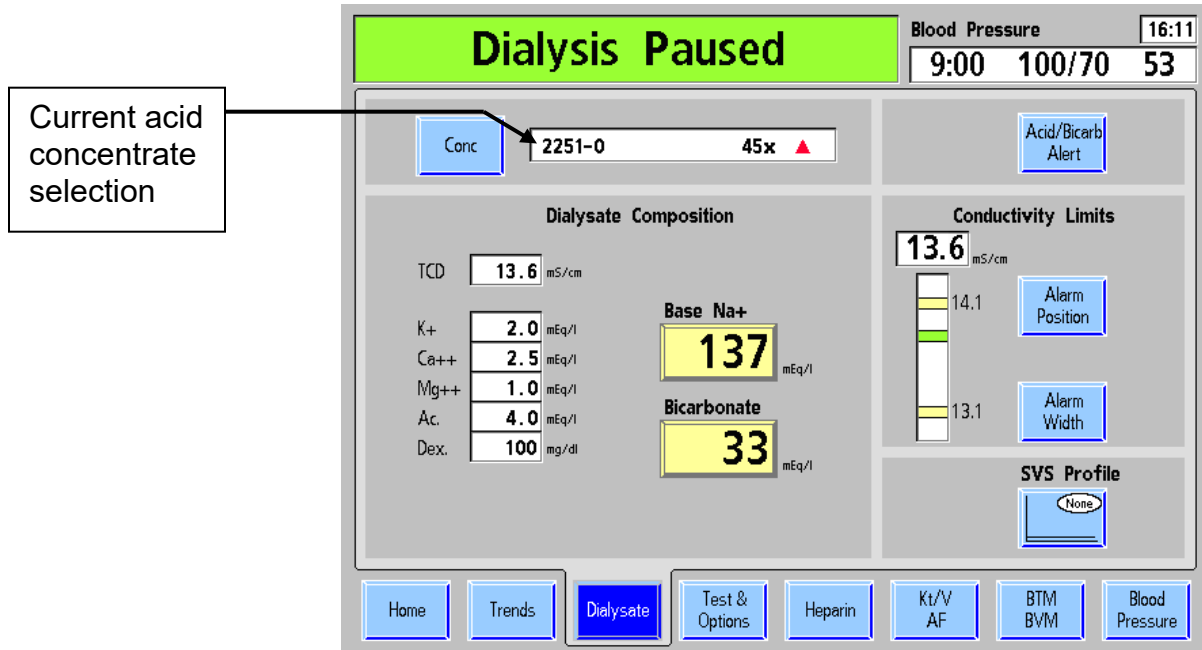

TREATMENT PREPARATION

Figure 20 – The Dialysate Screen



Note: If the machine is set up for use with Citrasate®, a ‘Citrate’ meter box will be displayed in the dialysate constituent list.

- After the concentrate displayed is correct, verify that the Base Na⁺ and Bicarbonate are as prescribed. Press the **CONFIRM** key, and then press the **Home** screen-key (located on the control panel directly below the **Home** screen-button).
- Insert the bicarbonate concentrate (blue) connector into a central bicarbonate supply or a jug containing sufficient bicarbonate concentrate for an entire treatment. Again, be sure the jug contains enough concentrate for the entire treatment.

Preparing the Extracorporeal Blood Circuit

Use Figure 21 or Figure 22, depending on the configuration of your machine, as a guide for connecting the bloodlines. The red lines on the machine are guides for arterial bloodline (from patient to dialyzer). The blue lines on the machine are guides for the venous bloodline (from the dialyzer to the patient). Be sure to use aseptic technique for all bloodline connections.



Note: To prepare the 2008K² hemodialysis machine for single-needle dialysis, see “Single Needle Dialysis” in Appendix A.

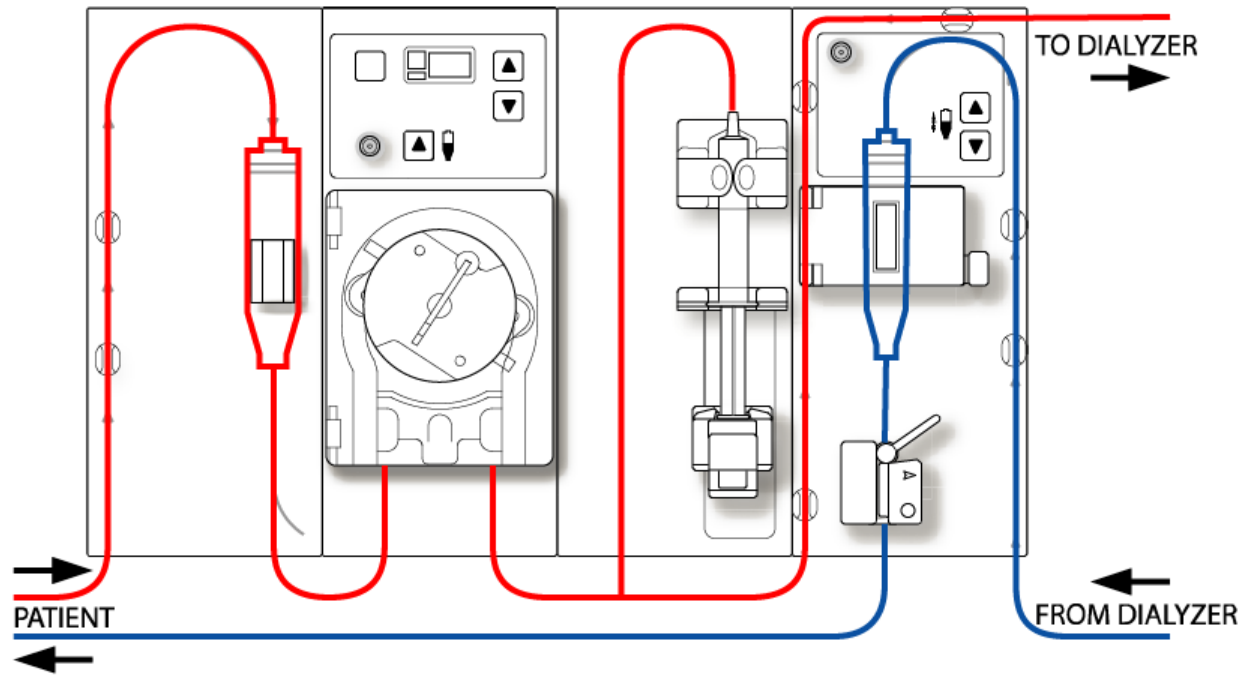

Figure 21 – Pre-pump Arterial Chamber Configuration

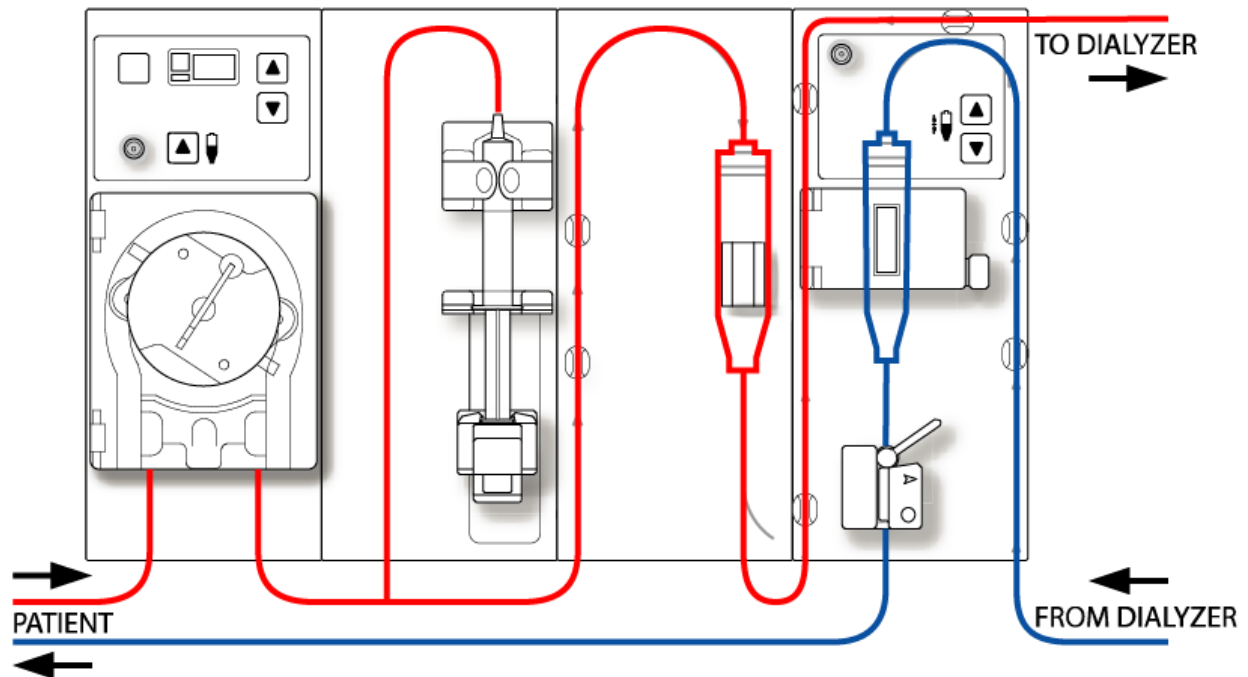

Figure 22 – Post-pump Arterial Chamber Configuration

Connecting the Extracorporeal Blood Circuit

For the following set of instructions, refer to Figure 10 – The Blood Pump Module on page 33 regarding the names of the various blood pump parts and Figure 12 – The Level Detector Module on page 35 regarding the names of the various module parts.

To connect the bloodlines:



Warning! Use aseptic technique.



Note: These are general instructions are for a new, dry-pack dialyzer. Your specific procedure should be consistent with the dialyzer manufacturer's instructions.

Arterial Bloodline Setup

1. Close medication port clamp
2. Snap the arterial chamber into its holder
3. Connect the arterial monitor line to the arterial pressure port using a transducer protector and verify that the monitor line is unclamped.



Warning! Transducer protectors should be used between transducers and each pressure monitor line of the extracorporeal system to prevent the transducers from getting wet. Wet transducer protectors must be replaced, as they will cause inaccurate pressure readings. If the external transducer protector and the internal transducer should become contaminated with blood, the transducer protectors **must** be replaced, and the transducer must be disinfected or replaced.

4. Open the blood pump door.



Warning! Inspect the blood pump rotor for proper operation (tubing guide posts not bent, rollers move freely, crank lever moves freely). Bent or loose tubing guide posts can damage bloodlines. Replace rotor if necessary. See page 128 for rotor diagram.

5. If necessary, set the pump for the diameter of the blood pump segment.
 - Press the Up (▲) and Down (▼) keys on the blood pump module simultaneously. The display will flash.
 - Press the Up (▲) or Down (▼) key on the blood pump module until the diameter of the pump segment being used is displayed.
6. Load the blood pump segment:
 - a. Press and hold the **Start/Stop** key on the blood pump module to align rotor for line insertion.
 - b. Grasp the pump segment and, using thumb pressure, position it behind the left yoke by pressing the tubing retainer inward. Be sure the end of the segment clears the bottom of the yoke.



Warning! Make sure the collar of the pump segment is positioned below the bottom of the yoke. This will minimize the possibility of the segment kinking during pump operation.

- c. Press and hold the **Start/Stop** key. The rotor will rotate to the 5 o'clock position and stop. Relieve pressure on the retainer and release the segment. The beginning of the pump segment should be secured between the left yoke and the tubing retainer.



Warning! Keep fingers free of rotor while it is turning to avoid possible injury

- d. Press and hold the **Start/Stop** key again and the rotor will rotate one full turn to automatically position the remainder of the segment within the pump housing. After loading, any extra pump segment tubing length should be on the right side of the pump.
 - e. Release the **Start/Stop** key when the pump segment has been inserted along the track inside the pump housing all the way to the right yoke.
 - f. Grasp the remaining portion of the segment and, using thumb pressure in a manner similar to step b, position it behind the right yoke.
 - g. Release the tubing retainer and close the pump door. Be sure the pump segment is free of kinks and both ends of the segment extend below the yoke.
7. Snap remaining arterial tubing in the clips along the red guidelines shown on modules.
 8. Aseptically place the patient end of the arterial line into the priming bucket clip. Snap the dialyzer end of the arterial bloodline into the dialyzer holder clip.
-



Warning! Do not allow the ends to touch the fluid in the bucket to prevent contamination.

Venous Bloodline Setup

1. Close medication port clamp
 2. Open the level detector door and roll the venous drip chamber into its holder with the filter below the sensor heads. Close and latch the door.
-



Warning! The level detector must be calibrated to the venous line model being used.

Warning! If the venous chamber contains a filter, be sure the filter portion of the chamber is positioned below the ultrasonic sensor heads of the drip chamber holder.

3. Connect the venous pressure monitor line to the pressure port. Be sure to insert a transducer protector between the line and the port. Verify that the monitor line is unclamped.
-



Warning! Transducer protectors should be used between transducers and each pressure monitor line of the extracorporeal system to prevent the transducers from getting wet. Wet transducer protectors must be replaced, as they will cause inaccurate pressure readings. If the external transducer protector and the internal transducer should become contaminated with blood, the transducer protectors **must** be replaced, and the transducer must be disinfected or replaced.

4. Snap remaining venous tubing in the clips along the blue guidelines shown on modules (do not insert the venous bloodline into the venous clamp yet).
 5. Snap the dialyzer end of the venous bloodline into the dialyzer holder clip.
 6. Aseptically place the patient end of the venous line into the priming bucket clip.
-



Warning! Do not allow the ends to touch the fluid in the bucket to prevent contamination.

Dialyzer Setup

1. Mount the dialyzer in its holder, arterial-end up.

Priming the Blood Circuit

There are two different ways to prime the blood circuit on 2008K² hemodialysis machine—Standard Prime method and Prime Amount method. The Standard Prime method allows the operator to prime the blood circuit by controlling the flow of the saline manually. The Prime Amount method is a machine option that is set in the Service Mode, and limits the amount of saline used in the priming procedure to a preset volume. Prime the blood circuit according to how your machine was set up. Follow your unit protocol or dialyzer manufacturer’s instructions for priming and rinsing dialyzers.

Standard Prime Method

1. Connect the dialyzer end of the arterial bloodline to the arterial port of the dialyzer. Rotate the dialyzer to the arterial end down position.
2. Connect the dialyzer end of the venous bloodline to the venous port of the dialyzer.
3. Insert the venous line in the venous line clamp and the optical detector. Close the optical detector door.



Warning! The tubing beneath the venous drip chamber must be inserted into the venous line clamp and the optical detector.

4. Hang a saline bag and attach an administration line, if not already attached, to the saline port on the arterial bloodline. Aseptically spike the saline bag.
5. Gravity prime the patient end of the arterial bloodline below the saline “T” with saline. When primed, clamp the patient end of the arterial bloodline.
6. If the heparin pump is to be used: connect the heparin syringe, prime the heparin line with heparin, and load heparin syringe into heparin pump. If the heparin pump is not used, clamp the heparin line.
7. Press the **Prime** key on the control panel to stop the blood pump.
8. Press the blood pump **Start/Stop** key and run the blood pump at a rate of 150 ml/min. Adjust the flow rate by pressing the ▲ (up) or ▼ (down) keys.
9. Fill the arterial drip chamber to an acceptable level using the ▲ key (level adjust) on the blood pump. Close the arterial pressure monitor line clamp and disconnect the line from the arterial pressure port so the port is open to atmosphere.



Warning! The ▲ Level Adjust key on the Blood Pump module can only be used to raise the level in the arterial chamber. Do not press the **Level Adjust** key so long that the pressure transducer protector becomes wet. Wet transducer protectors must be replaced to avoid erroneous pressure readings.

10. Run the blood pump to flush additional saline through the dialyzer until a fluid level is detected in the venous drip chamber. The blood pump will stop when the level detector detects an acceptable level of fluid.
11. Press the **RESET** key on the control panel to restart the blood pump and continue flushing saline through the blood circuit in accordance with established facility protocol regarding dialyzer rinsing.
12. After the required saline amount has passed through the dialyzer, press the **Start/Stop** key on the blood pump to stop the pump.
13. Clamp the patient end of the venous bloodline.
14. Adjust the fluid levels in the drip chambers by pressing the appropriate ▲ or ▼ level adjust keys. Close the venous pressure monitor line clamp and disconnect the monitor line from the venous pressure port so the port is open to atmosphere.
15. Aseptically connect the patient end of the arterial bloodline to the patient end of the venous bloodline using a sterile recirculation piece. Unclamp both lines.
16. Set the blood pump rate to 350-400 ml/min. Press the blood pump **Start/Stop** key to start the pump and begin recirculation. If necessary, press the **RESET** key to clear any alarms.
17. Ensure that the extracorporeal circuit is free of air bubbles.



Note: The dialysate lines will have to be attached at the appropriate point during the priming process, depending on facility procedure and manufacturer's instructions. If 1.5x or 2x dialysate flow (Auto Flow) is selected, be sure that the dialysate flow rate is at least the minimum required rate.

Prime Amount Method

1. Connect the dialyzer end of the arterial bloodline to the arterial port of the dialyzer. Rotate the dialyzer to the arterial end down position.
2. Connect the dialyzer end of the venous bloodline to the venous port of the dialyzer.
3. Hang a saline bag and attach an administration line, if not already attached, to the saline port on the arterial bloodline. Aseptically spike the saline bag.
4. Gravity prime the patient end of the arterial bloodline below the saline "T" with saline. When primed, clamp off the patient end of the arterial bloodline.
5. If the heparin pump is to be used: connect the heparin syringe, prime the heparin line with heparin, and load heparin syringe into heparin pump. If the heparin pump is not used, clamp the heparin line.
6. On the control panel, press the **Prime** key.
7. Press the blood pump **Start/Stop** key and run the blood pump at a rate of about 150-200 ml/min. Adjust the flow rate by pressing the ▲ (up) or ▼ (down) keys.

8. Fill the arterial drip chamber to an acceptable level using the ▲ key (level adjust) key on the blood pump. Close the arterial pressure monitor line clamp and disconnect the line from the arterial pressure port so the port is open to atmosphere.



Warning! The ▲ Level Adjust key on the Blood Pump module can only be used to raise the level in the arterial chamber. Do not press the **Level Adjust** key so long that the pressure transducer protector becomes wet. Wet transducer protectors must be replaced to avoid erroneous pressure readings.

9. The blood pump will start and continue to run until the pre-set amount of saline has been flushed through the circuit. When blood pump stops, clamp the patient end of the venous bloodline.
10. Insert the venous bloodline into the venous line clamp and optical detector on the level detector module. Close the optical detector door.



Warning! The tubing beneath the venous drip chamber must be inserted into the venous line clamp and the optical detector.

11. Adjust the fluid levels in the drip chambers by pressing the appropriate level adjust keys. Close the venous pressure monitor line clamp and disconnect the monitor line from the venous pressure port so the port is open to atmosphere.
12. Aseptically connect the patient end of the arterial bloodline to the patient end of the venous bloodline using a sterile recirculation piece. Unclamp both lines.
13. Set the blood pump rate to 350-400 ml/min. Press the blood pump **Start/Stop** key to start the pump and begin recirculation. If necessary, press the **RESET** key to clear any alarms.
14. Ensure that the extracorporeal circuit is free of air bubbles.



Note: The dialysate lines will have to be attached at the appropriate point during the priming process, depending on facility procedure and manufacturer's instructions. If 1.5x or 2x dialysate flow (Auto Flow) is selected, be sure that the dialysate flow rate is at least the minimum required rate.

Testing the 2008K² Hemodialysis Machine

Before beginning treatment, the machine should undergo Pressure and Alarm tests to ensure that it is functioning properly. Select the **Both Tests** button in the “Test & Options” screen using the Navigation Keypad and press the **CONFIRM** key to start the test. The 2008K² hemodialysis machine can be configured so that this testing is mandatory after power up providing that the force test option is selected. In this case, the test will start on its own.

To run the test sequence,

- The dialyzer lines must be connected to the shunt with the interlock door closed.
- The machine must be in an alarm-free condition by allowing sufficient time for the dialysate to reach proper conductivity and temperature. This takes about five minutes from the time the concentrate is confirmed on the dialysate screen (see Figure 20 on page 45).
- Arterial and venous monitor lines must be clamped and removed from the pressure monitor ports so the monitor ports are open to atmosphere.
- UF and SVS must be off.



Warning! It is essential that the 2008K² hemodialysis machine’s balancing system is operating properly. The machine must successfully complete a Pressure test before each treatment, especially when using high-flux dialyzers.

To run the Pressure and Alarm tests:

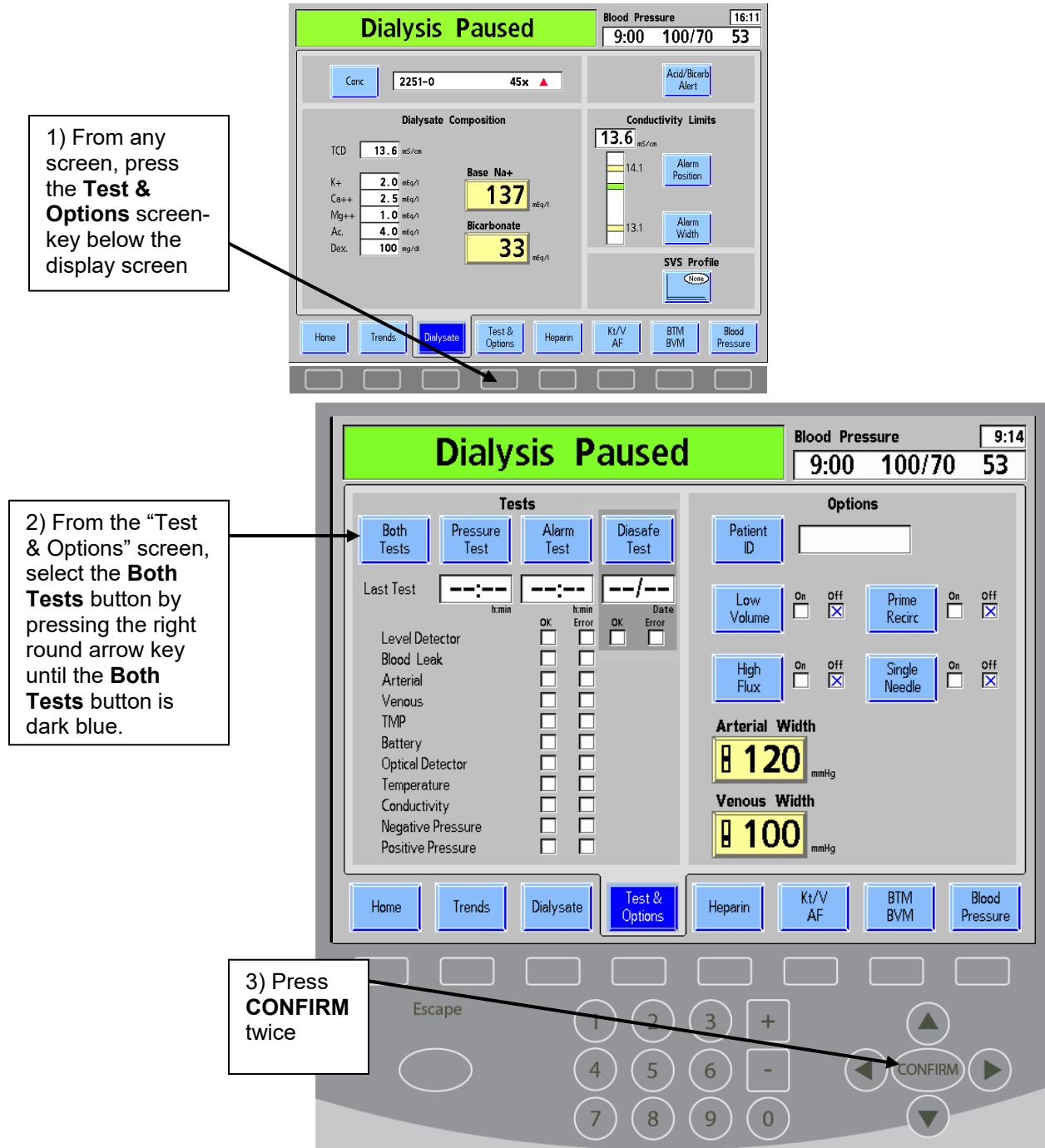

Figure 23 – Starting Automatic Tests

Test Sequence

The automated test sequence consists of two distinct parts—Alarm tests and Pressure Holding tests. The Pressure Holding Test, the Alarm test, or both tests can be started by selecting the

corresponding button on the “Test & Options” screen and pressing the **CONFIRM** key twice. After a long power down, however, only the **Both Tests** button is enabled.

Individual tests are identified as shown on the “Test & Options” screen. A failure of any of the tests is indicated by a red X in the error box to the right of the test name.

The Alarm test consists of nine individual tests that verify the integrity of the settable alarm limits of the system. Both the alarm and pressure tests should be conducted by the operator prior to each treatment.

The Pressure Holding Test (PHT) consists of two separate tests that are conducted sequentially. The purpose of the PHT test is to ensure the pressure integrity of the hydraulic system under actual pressures generated during the normal operation of the system. PHT must be performed before each high-flux treatment.

If all tests are completed successfully, a message TEST COMPLETE appears in the Status box. The operator must press **RESET** once to clear the message. Patient-specific treatment parameters (other than UF related) can be entered at any time during the test.

An audible alarm sounds only if a test has failed. In a failure situation, after all of the tests have been completed, the message BOTH TESTS FAILED, ALARM TEST FAILED, or PRESSURE TEST FAILED is displayed in the Status box depending on the nature of the failure. A red X appears in the failure box designating the test(s) failed. The right side of the screen provides additional information regarding the failure. A description of the test messages can be found in Chapter 6, “Troubleshooting”. Pressing the **RESET** key once mutes an alarm, pressing it a second time resets the right side of the screen.

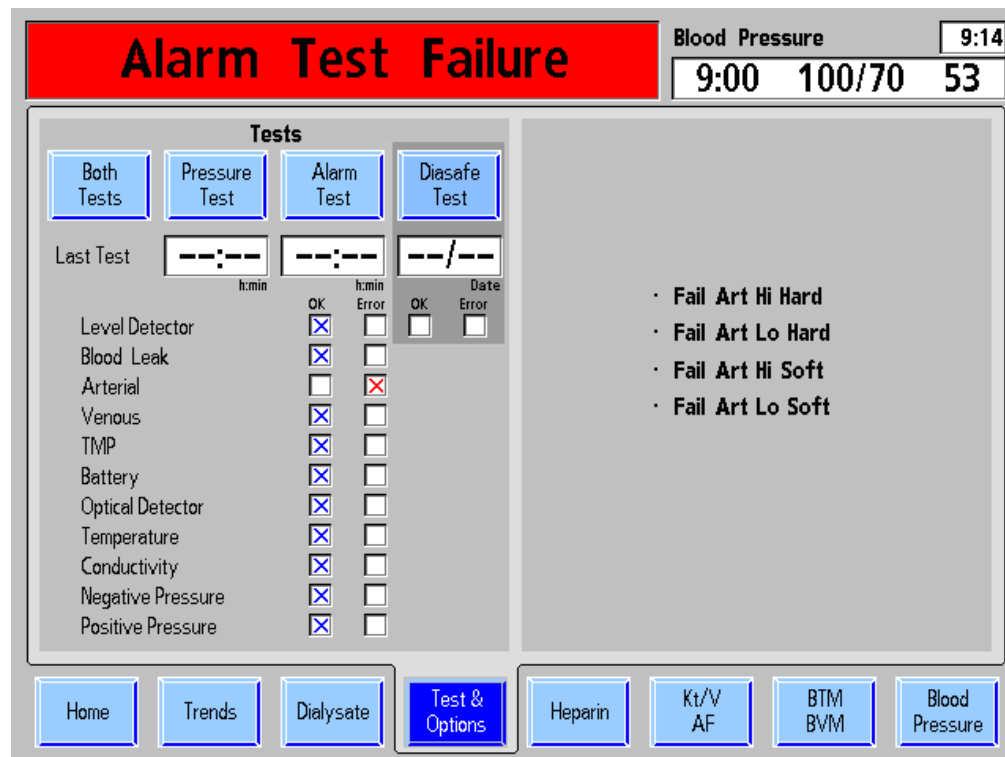

Figure 24 – Test Failure Screen



Warning! After selecting and confirming a test button, the machine will beep. As a test of the audible alarm system, make certain that the sound occurs. If the machine fails this or any of the Pressure, Alarm, and Diasafe tests and the cause cannot be corrected, or if it fails subsequent tests, it should not be used for treatment. Remove the machine from service and have it inspected by a qualified technician to correct the problem.

The 2008K² hemodialysis machine can be set up to perform online PHTs during treatment. These tests routinely happen every 12 minutes, and check the integrity of the hydraulic system. In the event of a failure, an alarm sounds and a warning message is displayed in the status box. For more information see “Online Pressure Holding Test” on page 117.

If your machine is set up with the automatically activated Diasafe test valve, you may initiate the Diasafe test from this screen. The date of the last test and test result is displayed.

Recirculation and Final Set-Up Procedure

1. Rotate dialyzer to arterial inlet up.
2. Check the conductivity and pH of the dialysate and test for residual disinfectant before connecting the dialysate lines to the dialyzer.



Warning! Always verify the conductivity and approximate pH of the dialysate solution through independent means (e.g. using a conductivity meter or pH paper or meter, as applicable) before initiating each dialysis treatment. Verify that the conductivity is reasonably close to the theoretical conductivity value (TCD) and the pH is between 6.9 and 7.6. If they are not, do not initiate dialysis.

3. Connect dialysate lines to dialyzer by matching the color of the quick connector to the color of the blood tube fitting. When done correctly, the red arterial blood tubing connector and the red quick connector of the dialysate line should be connected to the corresponding ports at the top of the dialyzer. This is to create a counter-current flow (blood flowing from top to bottom, dialysate flowing from bottom to top) inside the dialyzer to maximize clearance.
4. Pull on the dialyzer connectors to make sure they are firmly connected to the dialyzer.



Note: All dialyzer connectors must be fastened tightly to prevent air from entering the dialysate circuit or to prevent dialysate from leaking from the dialyzer.

5. Reconnect arterial and venous monitor lines to their respective ports. Unclamp the lines.
6. When the dialysate compartment is filled, rotate the dialyzer so the arterial inlet is down.
7. After priming the extracorporeal blood circuit, press **RESET** to clear all alarms. Set the blood pump rate to 350-400 ml/min and start the blood pump to begin recirculating the saline through the circuit.
8. Press the ▼ (down) key on the Level Detector module to lower the fluid level in the drip chamber. Verify that the blood pump stops and the venous clamp occludes.



Warning! The test of the level detector system must be run as a precaution and aid to identifying potential failures. Remove the machine from service if it fails this test.

9. Press the ▲ (up) key on the Level Detector module to raise the fluid level in the drip chamber to an acceptable level.

10. Check blood tubing to ensure that there are no kinks, especially between the blood pump and the dialyzer.



Warning! Kinked lines can cause hemolysis of the blood.

Warning! If using a dialyzer that has been stored in a liquid disinfectant such as formaldehyde or Puristeril 340, test the recirculating saline solution for residual disinfectant according to established facility protocol or the manufacturer's instructions. Special rinsing techniques must also be employed to assure the concentration of disinfectant is reduced and maintained at an appropriate level. These rinsing procedures are the responsibility of the medical director. The procedure must include a test for residual disinfectant and techniques to avoid rebound of the disinfectant. Turning the dialysate flow off when using a reused dialyzer may allow the chemical disinfectant to rebound (increase) to an unacceptable level.

11. Replace saline bag with a fresh bag if necessary.

12. Check for a normal dialysate flow by observing the rise and fall of the external flow indicator located on the dialyzer supply line. The float should drop four times in about 15 seconds for a 500 ml/min flow, or four times in 10 seconds for an 800-ml/min flow.

13. Open the shunt door and verify that the machine goes into bypass mode. In bypass mode, an audible alarm may sound, the bypass light on the control panel should light, and the float in the flow indicator of the dialyzer supply line should drop and remain at the bottom of the indicator.



Note: The 2008K² hemodialysis machine can be configured (in Service Mode) so that audible alarms occur only when the optical detector senses blood. If this option is not selected, an audible alarm will sound when the shunt interlock door is open.

Setting Treatment Parameters

This chapter instructs the patient care specialist on the procedures for entering patient-specific treatment parameters. The procedures for preparing the machine for daily use, in Chapter 2, must be completed prior to setting treatment parameters.

Before proceeding, be sure that:

- ✓ The machine has passed the alarm and pressure tests.
- ✓ The dialysate is at the proper temperature, conductivity, and pH.
- ✓ The dialysate has been tested and found free of residual disinfectant.



Warning! Do not connect a patient to the machine or attempt to set treatment parameters until these conditions have been met.

Warning! The values shown in pictures here are for example only. Parameters must be entered as prescribed by the patient's physician. Failure to enter correct parameters could result in serious injury or death.

Recommended Screen Order

The process of setting patient-specific treatment parameters requires using four of the eight main screens displayed on the display screen. The table below lists the order the screens should be opened, and parameter to set in each of them.

- **Dialysate Screen**—Access the Sodium and Bicarbonate level of the dialysate and display the constituent concentration as prescribed by the physician.
- **Home Screen**—Access the UF and Sodium Variation System (SVS) parameters, dialysate flow, dialysate temperature, display conductivity, and later, start the treatment.
- **Test & Options Screen**—Settings to treat Low Volume patients, perform single-needle dialysis, or use high-flux dialyzers are activated in this screen. The patient ID (if applicable) is also entered here.
- **Heparin Screen**—Set the parameters for administering heparin.
- **Kt/V AF Screen**—Set the parameters for the Kt/V display and run the Access Flow measurement.
- **BTM/BVM Screen**—If applicable, set the BTM and BVM parameters.
- **Blood Pressure Screen**—Set pressure and interval settings to facilitate taking pulse and blood pressure readings automatically.

New Treatment Key

When the 2008K² hemodialysis machine is first turned on in preparation for daily operation (after a long power down), all treatment parameters revert to their default settings. This can also be accomplished by pressing the **New TX** (New Treatment) key when in Dialysis Mode. The **New TX** key allows the operator to reset patient treatment parameters to their default settings without interrupting the power to the machine. This must be done in preparing the 2008K² hemodialysis machine for all subsequent treatments after the first of the day.

After pressing and confirming the **New TX** key or after a long power down:

- All treatment data (blood pressure, Kt/V) are deleted. The treatment summary information is moved to the previous record in the “Trends” screen.
- The RTD counter is reset to zero
- All heparin treatment parameters are reset to zero
- SVS profile is reset to None
- UF treatment parameters are reset as follows:
 - UF profile is reset to None
 - UF Removed is reset to zero
 - UF Goal = 3000
 - UF Time = 3:00
 - UF Rate = 1000
- The “Dialysate” screen is displayed and the concentrate will need to be confirmed

To activate the New Treatment Option:

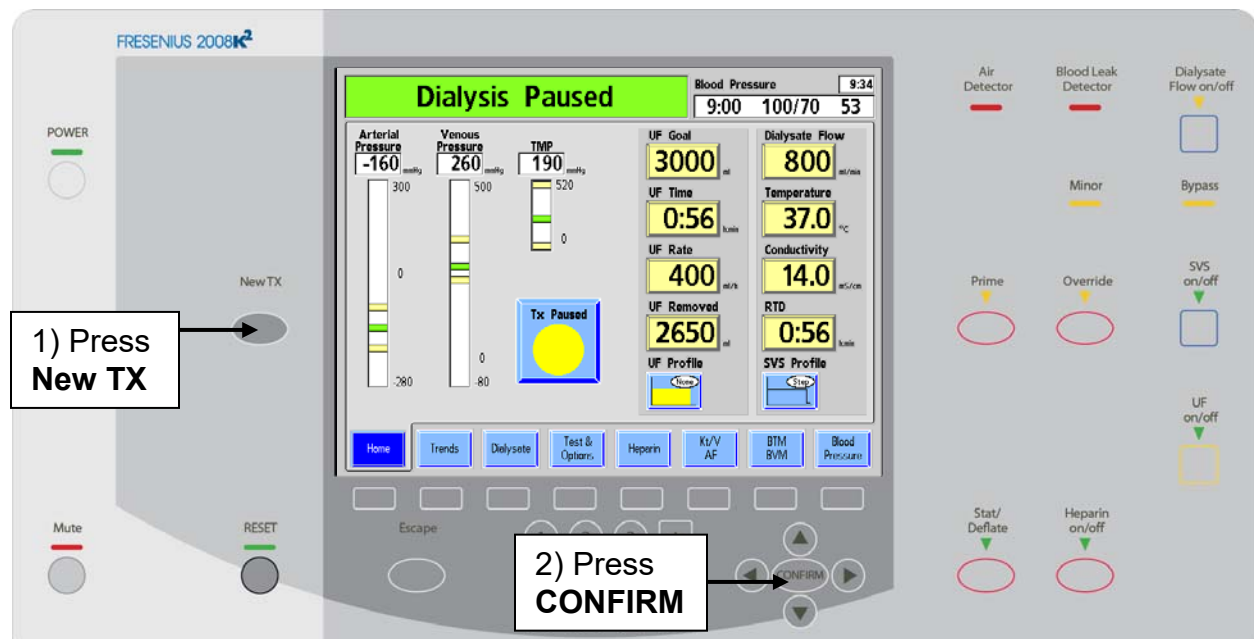

Figure 25 – New TX key

Entering a Parameter

Treatment parameters can be entered quickly and easily using the 2008K² keypad. All editable treatment data are displayed in yellow rectangular buttons in the treatment screens. To change a treatment parameter in any screen, select the parameter to change by pressing the round arrow keys on the Navigation Keypad until the parameter is highlighted. The selected button changes to a brighter shade of yellow or darker shade of blue when highlighted. Enter the new value using the numbers on the data entry keypad or **+** / **-** (plus or minus) keys located below the screen in the middle of the control panel. After entering the new parameter value, press the **CONFIRM** key to save it in the 2008K² hemodialysis machine's memory. The following example illustrates this procedure.

To set a treatment parameter:

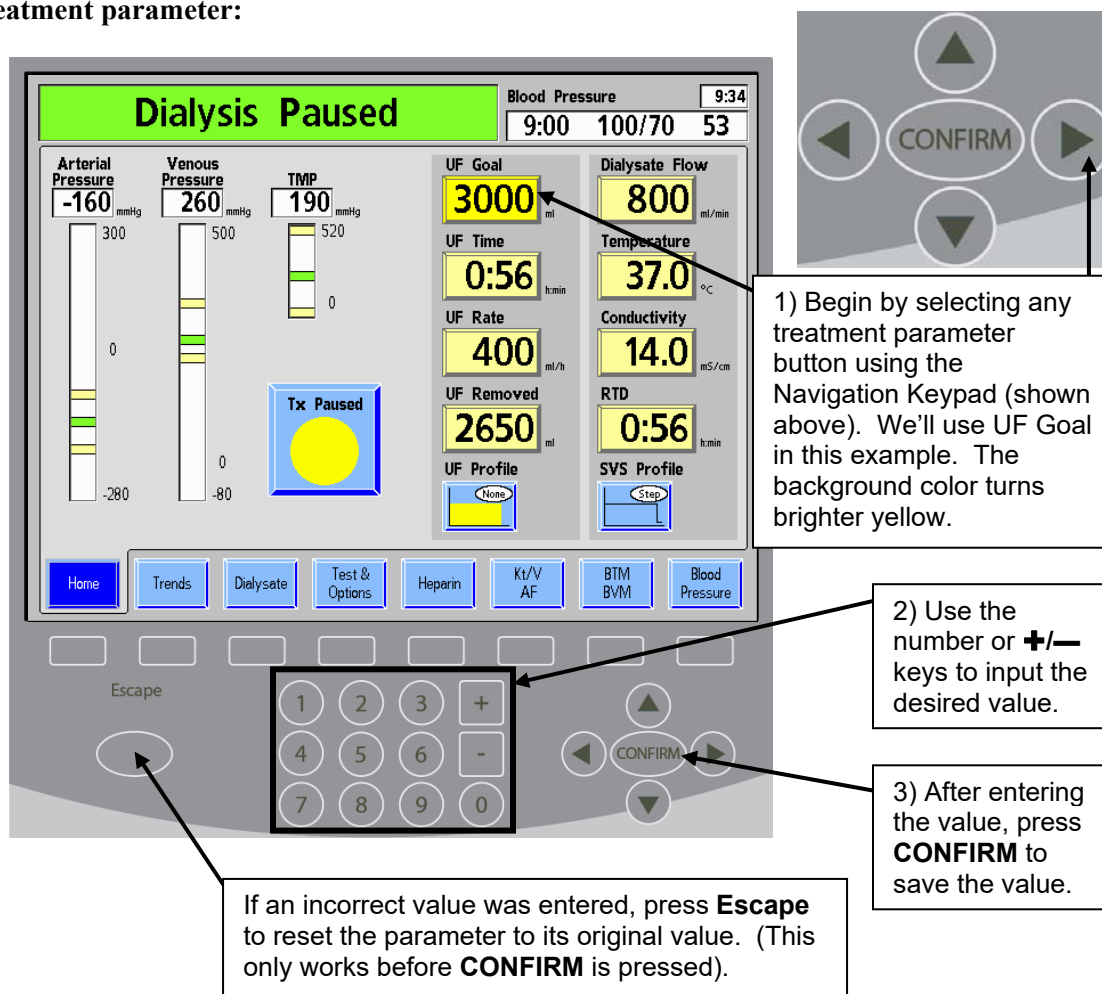

Figure 26 – Entering Parameters

An operator may attempt to enter data that is invalid. Some examples are:

- Attempting to enter a time of 1:80. The time format is hours:minutes. Anything over 59 minutes is not valid.

- Attempting to enter a time of 0:62. Until the **CONFIRM** key or another parameter entry button is selected, this is allowed because the operator may be intending to enter 6:20, which is valid.
- Attempting to enter a value that is above or below the allowed range of a parameter entry box. For instance, entering a Na value above 155 mEq/l is not allowed and therefore is an invalid entry.

When the **+** / **-** (plus or minus) keys are used to enter a value, the scrolling will stop at the upper or lower allowed values. If the operator enters an invalid time with the keypad, a message is shown in the Dialogue Box with the erroneous value and a message to press the **Escape** key. If an invalid parameter other than time is entered, the value will be entered as the lowest or highest allowed value, accompanied with a message in the Dialogue Box.

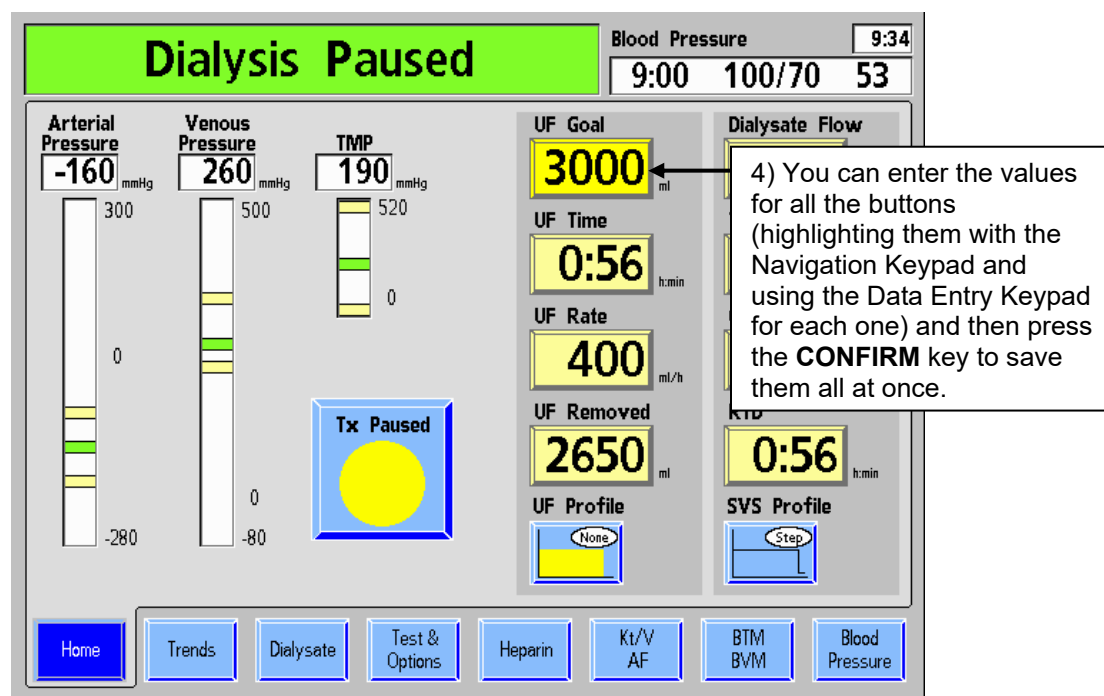

Figure 27 – Entering Parameters, continued

Dialysate Screen Settings

The “Dialysate” screen is displayed automatically at start up. It is also shown when either the **Dialysate** screen-key is pressed or **Conductivity** button in the “Home” screen is selected.

Within the “Dialysate” screen, the concentrations of base sodium (Na^+), bicarbonate, and other constituents are displayed. The Theoretical Conductivity (TCD)—the conductivity of the dialysate based on these concentrations—is displayed in the left side of the screen. The actual conductivity of the dialysate is displayed on the right side, above the Conductivity bar graph.

Most dialysate or dialysate-related alarm parameters are accessed from the “Dialysate” screen. Unless otherwise described, enter or change a dialysate-related value by following the procedure described in “Entering a Parameter” on page 59.

What to do from this screen...

Enter the prescribed dialysate settings for:

- Concentrate type
- Base Na⁺ level
- Bicarbonate level
- Sodium Variation (SVS) profile

Set Alarm limits for:

- Low Acid/Bicarbonate alert
- Position and width of Conductivity Alarm window



Warning! The specific concentrate and sodium and bicarbonate settings must be prescribed by a physician.

Note: If the machine is set up for use with Citrasate®, a ‘Citrate’ meter box will be displayed in the dialysate constituent list.

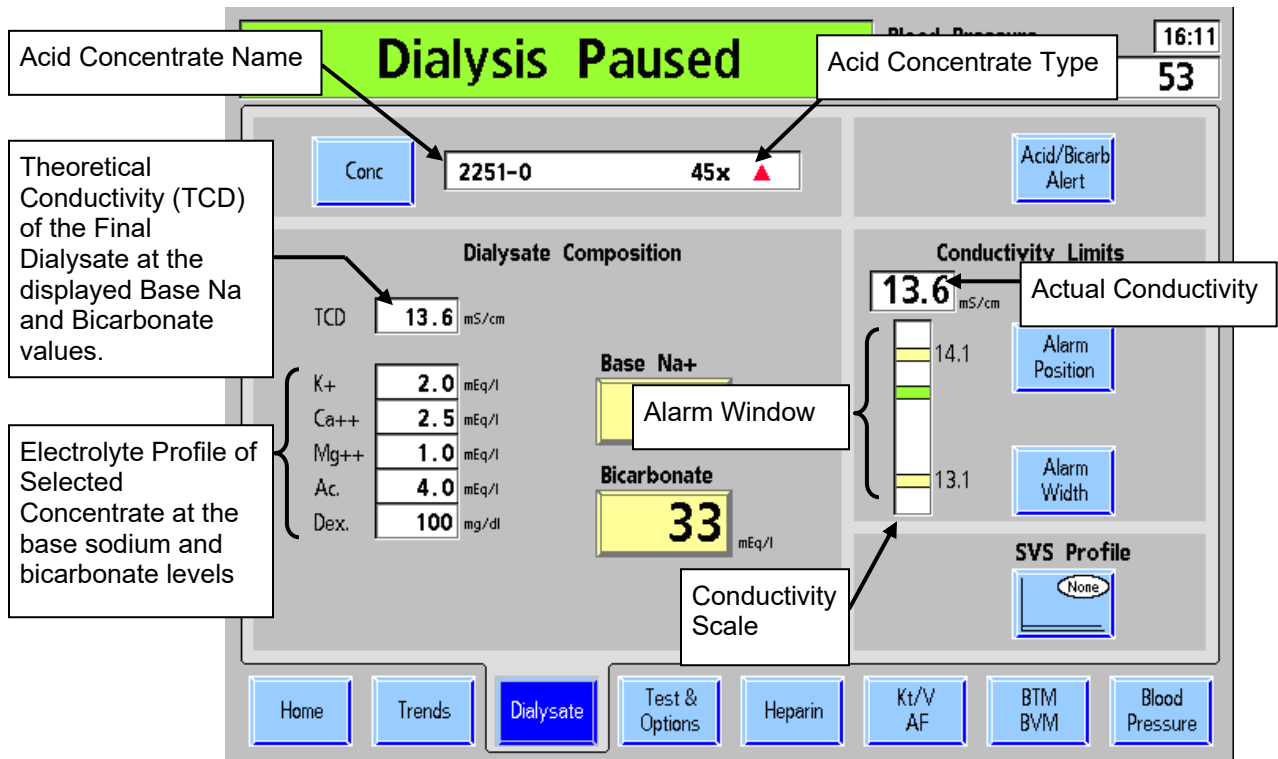

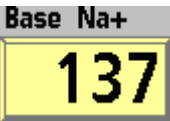
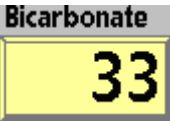
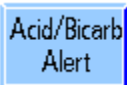





Figure 28 – The Dialysate Screen

The following table describes the features that can be programmed by the operator in the “Dialysate” screen.

Table 10 – Dialysate Screen Features

Button	Function
	Concentrate —Selecting the Concentrate button opens a subscreen to allow for the selection of an acid concentrate from a drop down menu. See “Figure 30 – Entering Concentrate Information” on page 67.
	Base Na⁺ —This is the prescribed base sodium (Na ⁺) that will be delivered to the dialyzer in the Final Dialysate (post proportioning and the reaction of the acid and bicarbonate concentrates). Selecting this button and using the + or – (plus or minus) keys on the data entry keypad, the operator can set the base sodium content of the dialysate in milliequivalents per liter (mEq/L). The values of some of the other constituents will change as this parameter is adjusted (see Table 11 on page 63 for more information).
	Bicarbonate —This is the prescribed bicarbonate that will be delivered to the dialyzer in the Final Dialysate (post proportioning and the reaction of the acid and bicarbonate concentrates). Selecting this button and using the + or – (plus or minus) keys on the data entry keypad changes the bicarbonate level in milliequivalents per liter (mEq/L). The values of some of the other constituents will change as this parameter is adjusted (see Table 12 on page 64 for more information).
	Acid/Bicarbonate Alert —Selecting this button opens a subscreen with options to notify the user when there is only 20 percent concentrate remaining in either supply jug. See “Setting the Acid/Bicarbonate Alert” on page 68.
	Alarm Position —Selecting this button and using the + or – (plus or minus) keys on the data entry keypad, the operator can shift the conductivity alarm window, up or down in 0.1 mS/cm increments. The alarm window can be shifted 0.5 mS/cm above or below the TCD of the selected concentrate type within the maximum upper limit of 16.0 mS/cm, and the minimum lower limit of 12.5 mS/cm. For more information, see “Conductivity Limits” on page 69.
	Alarm Width —Selecting this button and using the + or – (plus or minus) keys on the data entry keypad, the operator can change the width of the conductivity alarm window from 0.7 to 1.1 mS/cm width. For more information, see “Conductivity Limits” on page 69.
	SVS Profile —This button, which also appears in the “Home” screen, opens the “Sodium Variation System (SVS) Profile” subscreen. For more information, see “Sodium Variation System” on page 80. If the SVS option is set to ‘No’ in Service Mode, this button will not be displayed.

SETTING
PARAMETERS

Final Dialysate Composition

Final Dialysate contains sodium, bicarbonate, and the minor dialysate constituents shown on the “Dialysate” screen. The 2008K² hemodialysis machine maintains dialysate sodium and bicarbonate at the prescribed levels using a volumetric proportioning system. The conductivity of the dialysate is displayed and used to monitor, but not control, the Final Dialysate composition.

The dialysate constituents depend on the sodium and bicarbonate selections; they will change if either the sodium or bicarbonate selection changes. When the operator changes the prescribed bicarbonate (set in the **Bicarbonate** button), the acid stream also changes in order to keep the prescribed Final Dialysate sodium constant. Similarly, when the operator changes the prescribed sodium (set in the **Base Na+** button), the bicarbonate stream also changes in order to keep the prescribed Final Dialysate bicarbonate level constant.

The minor electrolyte constituents of potassium, calcium, and magnesium are part of the acid stream and will change from nominal settings when the bicarbonate or sodium is changed from nominal. For the NaturaLyte, GranuFlo, and Citrasate® brand concentrates, Table 11 provides examples of how potassium, calcium, and magnesium are affected as the prescribed sodium changes, first from the nominal 137 mEq/L to the lowest limit of 130 mEq/L and then the highest limit of 155 mEq/L. These changes to the dialysate composition keep the prescribed Final Dialysate bicarbonate level constant.

Table 11 – Final Dialysate Ranges in mEq/L with Bicarbonate Constant at 33 mEq/L

NaturaLyte 2251-0 with 4 mEq/L Acetate							
Prescribed Sodium	Sodium	Bicarbonate	Potassium	Calcium	Magnesium	Acetate	Dextrose
137 mEq/L nominal setting	137	33	2.0	2.5	1.0	4.0	100
130 mEq/L lowest setting	130	33	1.9	2.3	0.9	3.7	93
155 mEq/L highest setting	155	33	2.3	2.9	1.2	4.7	117
GranuFlo 2251-3B with 8 mEq/L Acetate (4 mEq/L Acetic Acid + 4 mEq/L Sodium Acetate)							
Prescribed Sodium	Sodium	Bicarbonate	Potassium	Calcium	Magnesium	Acetate	Dextrose
137 mEq/L nominal setting	137	33	2.0	2.5	1.0	8.0	100
130 mEq/L lowest setting	130	33	1.9	2.3	0.9	7.5	93
155 mEq/L highest setting	155	33	2.3	2.9	1.2	9.4	117

Citrasate® 2251-CA with 2.7 mEq/L Acetate (2.4 mEq/L Citrate + 0.3 mEq/L Acetate)								
Prescribed Sodium	Sodium	Bicarbonate	Potassium	Calcium	Magnesium	Citrate	Acetate	Dextrose
137 mEq/L nominal setting	137	34	2.0	2.5	1.0	2.4	0.3	100
130 mEq/L lowest setting	130	34	1.9	2.3	0.9	2.2	0.2	93
155 mEq/L highest setting	155	34	2.4	2.9	1.2	2.8	0.3	118

Table 12 below provides examples of how these same constituents are affected as the prescribed Final Dialysate bicarbonate instead changes, first from the nominal 33 mEq/L (34 mEq/L for Citrasate®) to the lowest limit of 20 mEq/L and then the highest limit of 40 mEq/L. These changes to the dialysate composition keep the prescribed Final Dialysate sodium level constant.

Table 12 – Final Dialysate Ranges in mEq/L with Sodium Constant at 137 mEq/L

NaturaLyte 2251-0 with 4 mEq/L Acetate								
Prescribed Bicarbonate	Sodium	Bicarbonate	Potassium	Calcium	Magnesium	Acetate	Dextrose	
33 mEq/L nominal setting	137	33	2.0	2.5	1.0	4.0	100	
20 mEq/L lowest setting	137	20	2.3	2.8	1.1	4.5	113	
40 mEq/L highest setting	137	40	1.9	2.3	0.9	3.7	93	
GranuFlo 2251-3B with 8 mEq/L Acetate (4 mEq/L Acetic Acid + 4 mEq/L Sodium Acetate)								
Prescribed Bicarbonate	Sodium	Bicarbonate	Potassium	Calcium	Magnesium	Acetate	Dextrose	
33 mEq/L nominal setting	137	33	2.0	2.5	1.0	8.0	100	
20 mEq/L lowest setting	137	20	2.3	2.8	1.1	9.0	113	
40 mEq/L highest setting	137	40	1.9	2.3	0.9	7.5	93	
Citrasate® 2251-CA with 2.7 mEq/L Acetate (2.4 mEq/L Citrate + 0.3 mEq/L Acetate)								
Prescribed Bicarbonate	Sodium	Bicarbonate	Potassium	Calcium	Magnesium	Citrate	Acetate	Dextrose
34 mEq/L nominal setting	137	34	2.0	2.5	1.0	2.4	0.3	100
20 mEq/L lowest setting	137	20	2.3	2.8	1.1	2.8	0.3	114
40 mEq/L highest setting	137	40	1.9	2.4	0.9	2.3	0.2	94

The following table shows the full extent of those changes to the electrolyte constituents in the Final Dialysate composition with sodium (Base Na⁺) at 137 mEq/L and post-reaction bicarbonate at 33 mEq/L (34 mEq/L for Citrasate®), 20 mEq/L, and 40 mEq/L:

Table 13 – Example of “Dialysate” Screen Dialysate Composition Ranges with Sodium Constant at 137 mEq/L

NaturaLyte	GranuFlo	Citrasate®
<p>Nominal Bicarbonate Setting</p>	<p>Nominal Bicarbonate Setting</p>	<p>Nominal Bicarbonate Setting</p>
<p>Minimum Bicarbonate Setting</p>	<p>Minimum Bicarbonate Setting</p>	<p>Minimum Bicarbonate Setting</p>
<p>Maximum Bicarbonate Setting</p>	<p>Maximum Bicarbonate Setting</p>	<p>Maximum Bicarbonate Setting</p>

SETTING PARAMETERS

Setting an Acid/Bicarbonate Type

Acid/bicarbonate concentrate types are programmed into computer memory of the 2008K² hemodialysis machine. If the current patient’s prescribed dialysate differs from the previous patient’s, or if the machine is new or has been recalibrated, a new acid/bicarbonate concentrate type matching the dialysate prescribed by the current patient’s physician must be entered.

To enter the acid/bicarbonate concentrate type:

SETTING PARAMETERS

1) From the “Dialysate” screen, select **Conc** with the Navigation Keypad and press the **CONFIRM** key. The “Concentrate” subscreen opens.

The screenshot shows the 'Dialysis Paused' screen with the following data:

- Conc:** 2251-0, 45x ▲
- Dialysate Composition:**
 - TCD: 13.6 mS/cm
 - K+: 2.0 mEq/l
 - Ca⁺⁺: 2.5 mEq/l
 - Mg⁺⁺: 1.0 mEq/l
 - Ac: 4.0 mEq/l
 - Dex: 100 mg/dl
 - Base Na⁺: 137 mEq/l
 - Bicarbonate: 33 mEq/l
- Conductivity Limits:**
 - Current: 13.6 mS/cm
 - Upper Limit: 14.1
 - Lower Limit: 13.1
- SVS Profile:** None
- Blood Pressure:** 9:00, 100/70, 53
- Time:** 16:11

Navigation buttons at the bottom include: Home, Trends, **Dialysate**, Test & Options, Heparin, Kt/V AF, BTM BVM, and Blood Pressure.

Figure 29 – Enter Acid & Bicarbonate Type

1) The electrolyte profile of the highlighted selection is displayed in this column.
Note: If the machine is set up for use with Citrasate®, a 'Citrate' meter box will be displayed in the dialysate constituent list.

2) Highlight the desired selection by scrolling through the choices using the **+** or **-** (plus or minus) keys on the data entry keypad. Acetate formulations can also be selected as a treatment option.

3) When the desired type is highlighted, press the **CONFIRM** key on the control panel to save the selection and return to the "Dialysate" screen.
Note: Be sure the acid/bicarbonate concentrations connected to the machine match the type selected from the Concentrate menu.

4) Press the round down arrow key on the Navigation Keypad until the **Base Na+** button is selected. Enter the prescribed Base Na+ and Bicarbonate values using the Data Entry Keypad and then press the **CONFIRM** key to save the change. Repeat the above steps to enter the Bicarbonate value.

SETTING PARAMETERS

Figure 30 – Entering Concentrate Information

Setting the Acid/Bicarbonate Alert

The Acid/Bicarbonate Alert option sounds an alarm when the fluid level in either of the concentrate jugs has been drained to 20 percent of its original amount. In addition to the alarm, a warning message such as LOW ACID WARNING, LOW BIC WARNING, or LOW ACETATE WARNING will appear in the status box. This alert aids the operator in maintaining adequate amounts of concentrate in the containers during treatment. Be sure to set the new volume in this screen whenever the concentrate containers are refilled.

SETTING PARAMETERS

1) From the “Dialysate” screen, select **Acid/Bicarb Alert** and press **CONFIRM**. The “Acid/Bicarb Alarm” subscreen appears.

2) Select **Acid**. Using the data entry keypad, enter the actual amount, in liters, of concentrate in the acid jug.

3) Select **Bicarbonate**. Using the data entry keypad, enter the actual amount, in liters, of concentrate in the bicarbonate jug.

4) Select **Alert** and press the **CONFIRM** key, then press the round left arrow key on the Navigation Keypad until an **X** appears in the On checkbox.

Note: If the facility is on a centralized acid or bicarbonate supply system, enter zero to deactivate the alarm for that concentrate.

5) Press **CONFIRM** to save the input data.

6) Press the **Dialysate** screen-key to exit the “Acid/Bicarb Alert” subscreen. The volume of each concentrate will count down as it is used.

Figure 31 – Setting Acid & Bicarbonate Alerts

Conductivity

The Theoretical Conductivity (TCD) represents the expected conductivity for the selected concentrate at the set Na⁺ and bicarbonate levels. It is displayed above the electrolyte constituents on the left side of the “Dialysate” screen (see Figure 28 on page 61). The actual conductivity of the Final Dialysate is displayed above the conductivity bar graph on the right side of the “Dialysate screen.” It is represented by a horizontal bar in the conductivity graph. The bar appears green when the conductivity is within alarm limits, and turns red when the actual conductivity is outside the alarm window. With both concentrate supplies connected to the machine, a stable, accurate conductivity reading should be attained about five minutes after the concentrate is confirmed in the “Dialysate” screen.

Conductivity Limits

As the operator changes the sodium or bicarbonate settings, the TCD (Theoretical Conductivity) will change. The alarm limits are set around the TCD. The alarm window is the area between the upper and lower alarm limits. The upper and lower alarm limits are shown by yellow horizontal lines in the conductivity bar graph. They are set 0.5 mS/cm above and below the TCD by default. The conductivity alarm sounds when the actual conductivity of the dialysate climbs or falls outside of this window. The alarm window can be shifted up or down to within 0.5 mS/cm of the default setting using the **Alarm Position** button (with the data entry keypad), and widened or narrowed using the **Alarm Width** button (and the data entry keypad). The width of the alarm window can be set from a minimum of 0.6 mS/cm to a maximum of 1.0 mS/cm, within the range of 12.5–16.0 mS/cm.

The following examples illustrate how to set the conductivity alarm window:

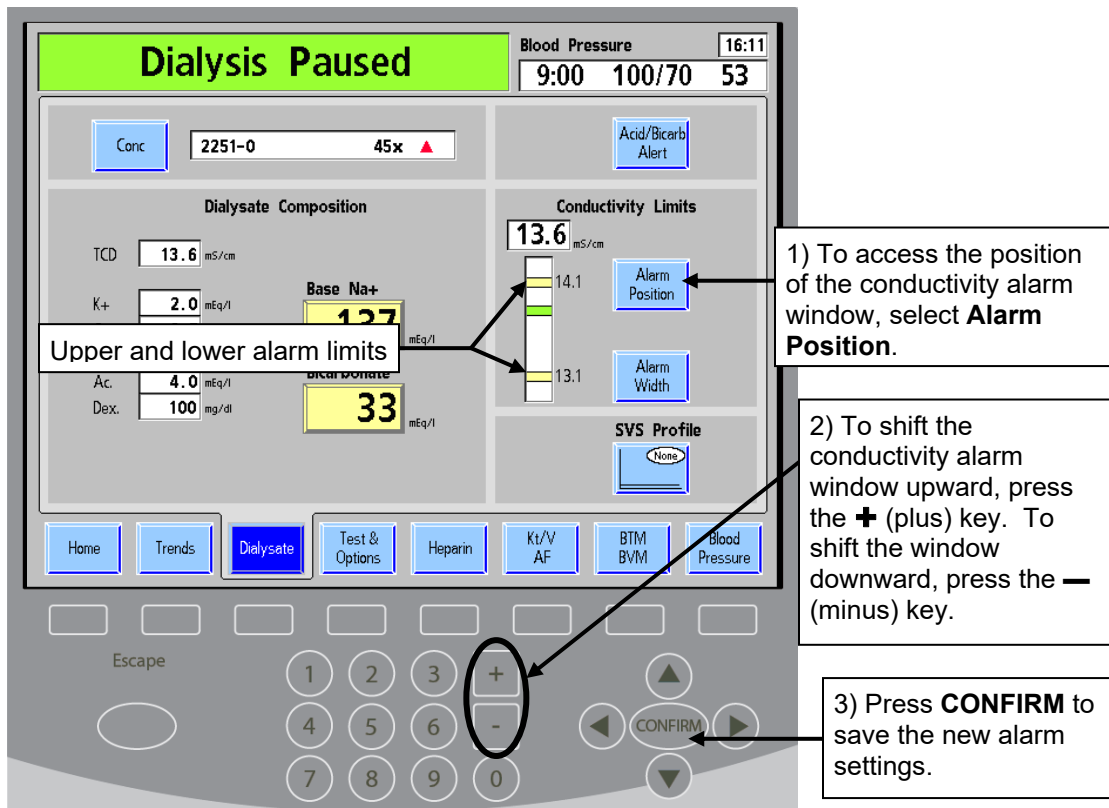

Figure 32 – Changing Conductivity Limits

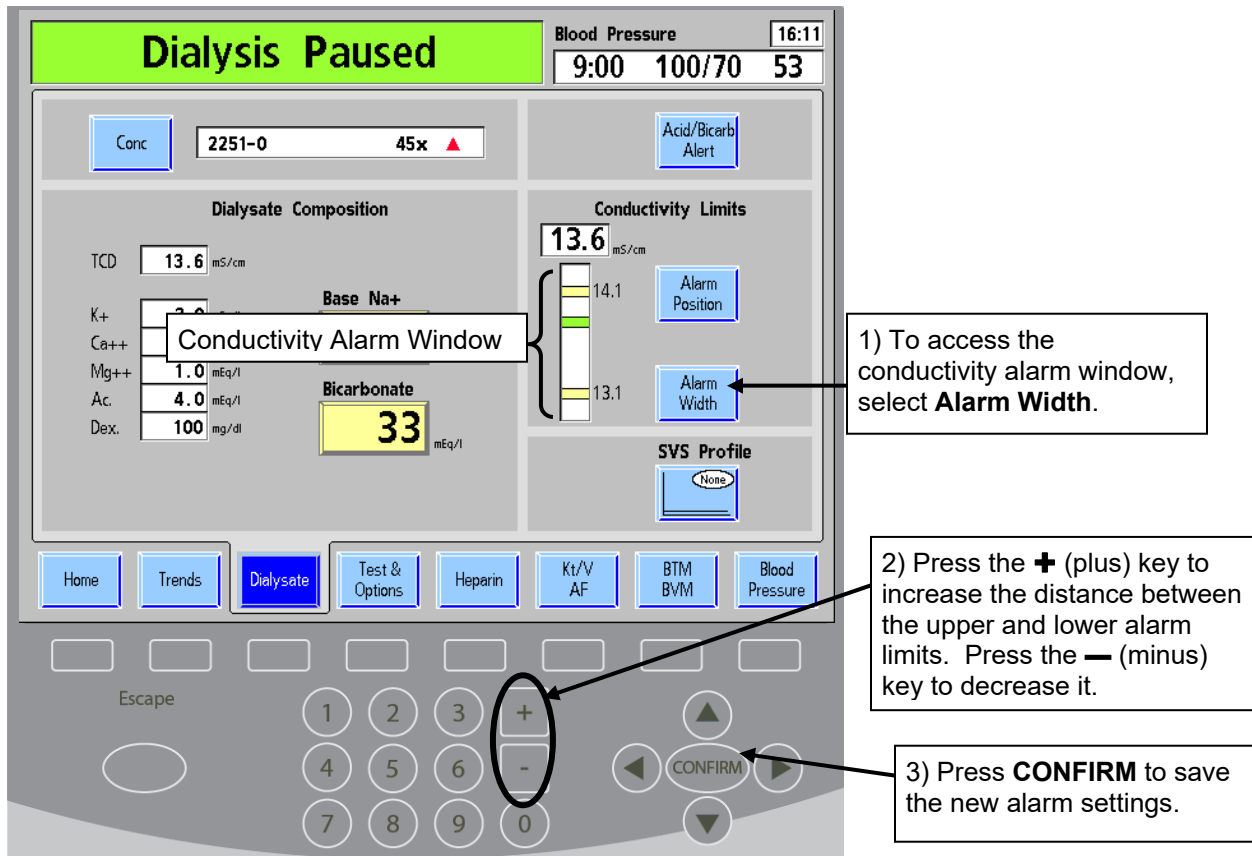

Figure 33 – Changing Conductivity Limit Width



Warning! Always verify the conductivity and approximate pH of the dialysate solution through independent means (e.g. using a conductivity meter or pH paper or meter, as applicable) before initiating each dialysis treatment. Verify that the pH is between 6.9 and 7.6 and that the conductivity is reasonably close to the theoretical value (TCD). If they are not, do not initiate dialysis.

Home Screen Settings

After entering the data in the “Dialysate” screen, treatment parameters regarding treatment length, ultrafiltration, and the administration of sodium can be entered in the “Home” screen. The “Home” screen can also provide a view of the status of the treatment once it has begun (see “Home Screen Monitoring” on page 97). Unless otherwise described, enter or change a dialysate-related value by following the procedure described in “Entering a Parameter” on page 59.



Note: The 2008K² hemodialysis machine is equipped with both visual cues and audible alarms to alert the operator to potential problems. In every alarm condition, assess the patient for any changes in his/her physiologic state. Ensure that the patient’s access is exposed and all connections in the extracorporeal circuit are secure and visible during the entire procedure. It is the responsibility of the dialysis personnel to provide safe and effective dialysis treatment. Document all unusual events.

SETTING
PARAMETERS

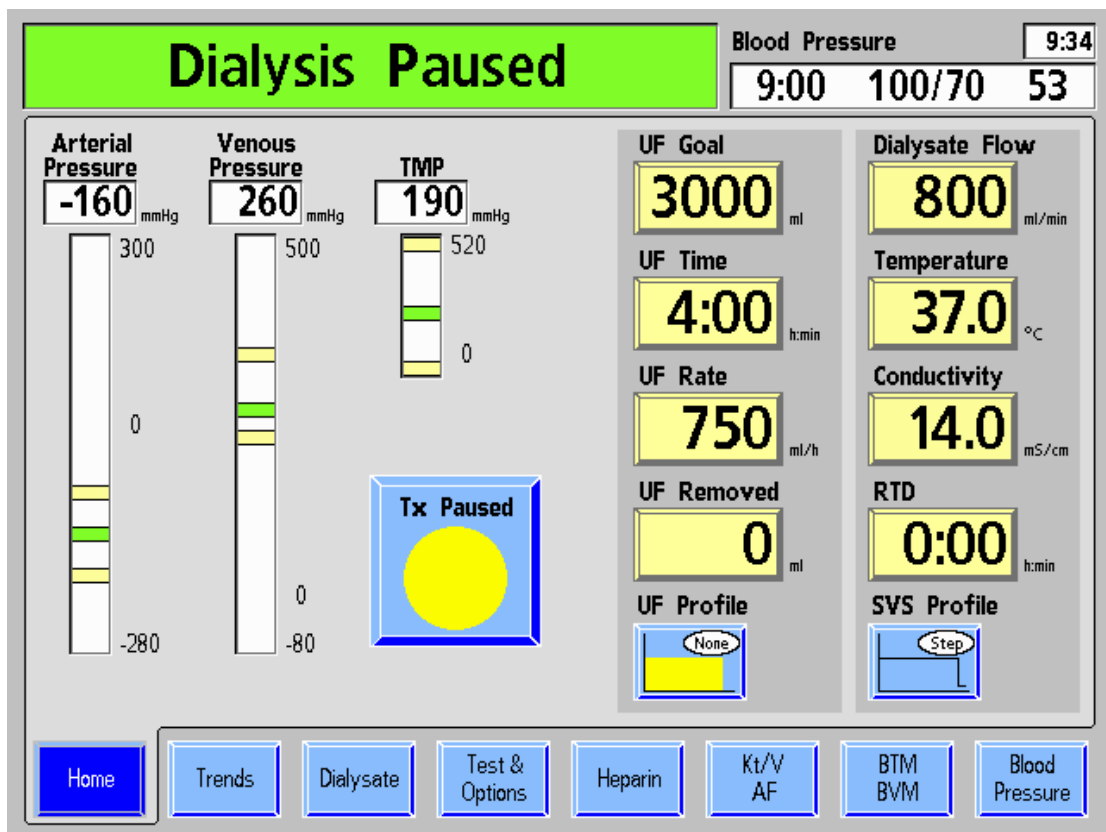

Figure 34 – The Home Screen

What to do from this screen...







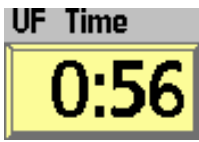
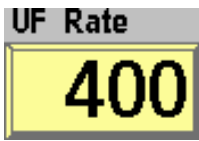

Enter the prescribed treatment settings for:

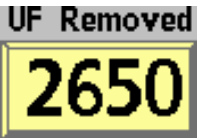
- UF Goal
- UF Time
- Check UF Rate (Calculated from UF Goal and UF time)
- Dialysate Flow
- Dialysate Temperature
- Treatment Time (RTD) (optional; RTD will transfer from UF time if UF removed is 0 when UF is turned on.)
- Start or pause the Tx Clock
- If prescribed, access the proper screen to set treatment parameters for:
 - UF profile
 - Sodium Variation (SVS) profile

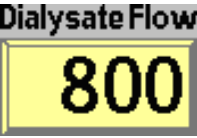
The following table provides a description of the data buttons available in the “Home” screen.

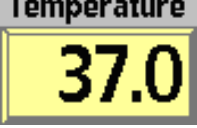
Table 14 – The Home Screen Buttons

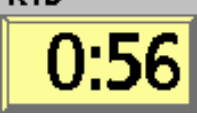
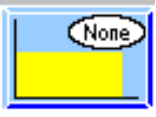
Button	Function
	The amount of fluid (in ml) to be removed during the entire treatment is entered here. This button is also available in the “UF Profile” subscreen if a profile is to be used to vary the rate of ultrafiltration during treatment. If the UF Goal is set to zero, the UF Time will also change to zero; the UF Rate may then be set independent of UF Time and UF Goal.
	The length of treatment time during which ultrafiltration will occur is entered here in hours and minutes (hr:min). UF Time will generally be equal to treatment time and will automatically transfer to the RTD button. Once treatment begins, this button acts as a countdown timer indicating the amount of time left for ultrafiltration. This time can be increased or decreased by the operator at any time. Changing the UF Time or UF Goal will change the UF Rate accordingly except when the UF Goal is set to zero. If the UF Rate is adjusted, the UF Time will be automatically calculated without affecting the UF Goal. To run Isolated Ultrafiltration, see “Isolated Ultrafiltration” on page 78. A blood alarm will stop this timer.
	Enter here, in 10 ml/hr increments, the rate fluid will be drawn from the patient (ultrafiltration). Generally the UF rate is not entered, but rather automatically calculated from the UF Goal and UF Time. If the UF Rate value is manually changed, the UF Time value will automatically change accordingly.

Button	Function
UF Removed 	<p>Displays the total amount of ultrafiltration removed in ml. The counter keeps track of the UF in 1 ml increments.</p> <p> Warning! UF Removed must be reset to 0 before initiating treatment. If the UF Removed is not reset, the amount displayed will be used in the UF calculation, resulting in incorrect UF removal from the patient.</p>
Dialysate Flow 	<p>The prescribed dialysate flow rate, in ml/min, is entered here. The rate, displayed in ml/min, can be entered from 0 to 800 in increments of 100. If flow is set at zero for sequential dialysis, the button displays “SEQ”. For more information on sequential dialysis, see page 78.</p> <p>Depending on the selection in Service Mode, “1.5x” or “2x” Auto Flow may be selected by scrolling up past 800. If this automatic selection is set, the dialysate flow rate will be set to approximately 1.5 or 2 times the blood flow rate between 500 and 800 ml/min, in 100 ml/min increments. When “1.5x” or “2x” is selected and confirmed, the dialysate flow rate will be indicated with the letter “a” preceding the dialysate flow rate, such as: “a500”. See “Using Auto Flow” on page 214 for more information.</p> <p> Warning! Setting the dialysate flow to a rate that is too low can adversely affect dialyzer clearance and reduce treatment efficacy. If auto flow selects a flow rate below that prescribed, the dialysate flow may be manually set to the desired value.</p>
Temperature 	<p>The desired temperature of the dialysate in degrees Celsius is set here. Once this setting is confirmed, the button will display the actual temperature. The allowable temperature setting range from 35 °C to 39 °C. A temperature alarm occurs when the actual temperature rises or falls 2 °C beyond the set temperature. If SEQ dialysate flow is selected, the temperature is “N/A”, since there is no dialysate flow.</p>
Conductivity 	<p>The actual conductivity is displayed. If the button is selected and confirmed, the “Dialysate” screen is brought up.</p>
RTD 	<p>RTD (Remaining Time of Dialysis)—At the start of the treatment, the time entered in the UF Time button is automatically transferred to the RTD button if UF removed is 0. If it is necessary to change the treatment time, RTD can be entered here. A dialysate or blood alarm will stop this timer.</p>
UF Profile 	<p>Ultrafiltration (UF) Profile—Opens the “UF Profile” subscreen from which a profile for executing variable rate ultrafiltration can be selected. The button displays the current profile selection. For more information, see “Setting a UF Profile” on page 75.</p>
SVS Profile 	<p>Sodium Variation System (SVS) Profile—This button opens the “SVS Profile” subscreen from which the operator can select how sodium is varied during the course of the treatment. For more information, see “Sodium Variation System” on page 80. If the SVS option is set to ‘No’ in Service Mode, this button will not be displayed.</p>



Button	Function
	<p>The Treatment Clock button is selected and confirmed to start or pause the treatment. The green segment of the pie chart represents the amount of treatment completed. The green segment grows as the treatment progresses. The circle will be completely green when RTD is equal to zero. During treatment, this button displays the message, “Tx Running.”</p>
	<p>Selecting and confirming this button will pause the treatment clock and the button will display the message, “Tx Paused.” When the treatment is paused, the RTD, heparin infusion time, and UF time each stop counting down, the UF and heparin pumps stop, and the SVS time is paused. The appropriate LED indicators will flash. Turning the Treatment Clock back on will restore operation of these parameters unless turned off with the respective front panel on/off key.</p>
	<p>The first time the Treatment Clock is turned on, the UF Removed is reset to 0 and the UF, Heparin pumps and SVS & UF programs are turned on and a blood pressure reading is taken, if applicable.</p>

Table 15 – SVS and UF Control Keys

Key	Function
	<p>The SVS on/off key activates the Sodium Variation System (SVS) program. It is located on the right side of the control panel, above the UF on/off key. When the SVS is on, the green light is illuminated.</p> <p>This light will flash when SVS program is interrupted. When interrupted, the Na will remain at its current level without change. The program will resume when the Treatment Clock is turned back on.</p> <p>If the SVS on/off key is pressed to turn off the SVS program during dialysis, the Na will return to its base value and the program will not resume with the Treatment Clock button.</p> <p>If OLC is enabled, the machine looks for a stable conductivity. If SVS is turned on during this time, the LED will turn on but the program will not begin until stable conductivity is achieved. During this time, the SVS program cannot be turned off.</p> <p>If the SVS option is set to ‘No’ in Service Mode, the Sodium Variation System is not available.</p>
	<p>The UF on/off key turns the ultrafiltration pump on or off. It is located on the lower, right side of the control panel. During ultrafiltration, the green light is illuminated.</p> <p>This light flashes when ultrafiltration is interrupted, and the UF Time countdown stops. Operation will resume when the Treatment Clock is turned on or the UF on/off key is pressed.</p> <p>If the UF on/off key is pressed during dialysis to turn off the UF pump, it will not resume with the Treatment Clock button.</p>

Ultrafiltration

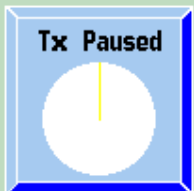
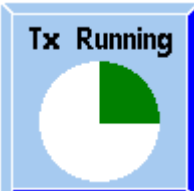
Use the **UF Goal** and **UF Time** buttons to determine the necessary UF rate for the treatment. The maximum UF rate (set in Service Mode) is limited to between 1000 ml/hr or 4000 ml/hr (at 1000 ml/hr intervals), depending on the option selected. The UF Goal is limited to 9990 ml. Reset the UF removed to zero after setting the UF time. The ultrafiltration will be at a steady rate throughout the treatment. When the **UF on/off** key is turned off, no ultrafiltration is occurring. When the **Tx Clock** button is turned on, the UF pump (as well as a number of other functions) is automatically started. When the UF goal has been achieved, the UF time is set to 0:00, and the UF rate goes to 70 ml/hr (conventional dialyzers) or 300 ml/hr (high flux dialyzers). If a profile (variation during treatment) is desired for the UF rate, use the **UF Profile** button.



Warning! When using high-flux dialyzers with low UF rates there is a possibility of back-filtration. Back filtration depends on: type of high-flux dialyzer, flow resistance on dialysate and blood sides, and blood viscosity.





Note: Weigh the dialysis patient before and after treatment to check against fluid removal discrepancies.



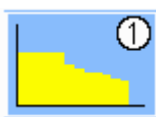

Setting a UF Profile

The different UF Profiles available are used to improve patient comfort during dialysis by providing alternating patterns of high and low rates of ultrafiltration. This also allows the fluid in the patient to equilibrate more completely between the intracellular and extracellular compartments. A UF profile divides the UF Time into twelve equal segments of differing UF rates, based on the profile, in order to reach the prescribed UF Goal.

To view the available profiles, select the **UF Profile** button on the “Home” screen. The “UF Profile” subscreen will open displaying up to eight possible profiles and a selection for “None.” The first four profiles are standard profiles. The fifth through eighth profiles are programmable to meet the needs of the clinic.

Table 16 – The UF Profile Subscreen Buttons

Button	Function
	Profile 1 – Increases the UF rate for approximately the first 40% of the treatment then gradually decreases.
	Profile 2 – Aggressive level UF with a gradual decline.

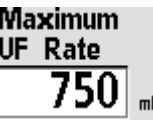
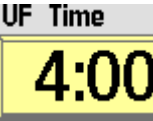
Button	Function
	Profile 3 – Moderate level UF increase throughout approximately the first 60% of treatment and declines to a minimum.
	Profile 4 – Low-level UF moving into a series of decreasing peaks and valleys for the first two-thirds of the treatment followed by a plateau of moderate UF to completion.
	Profiles 5, 6, 7, 8 – Customizable in Service Mode, see page 213 for more information. The images on these buttons will match the appearance of the customized profiles.
	None – Ultrafiltration occurs at a constant minimum rate calculated from the set UF Time in order to reach the set UF Goal. It does not mean that no ultrafiltration will occur.
	UF Goal – This is the value from the “Home” screen, see page 72 for more information.
	Maximum UF Rate – Once the UF Goal and UF Time are entered, the Maximum UF Rate for the selected profile is calculated and displayed here. The calculated rate cannot exceed the Maximum UF Rate limit set in Service Mode, see Figure 75 – Service Mode: Options: Default Settings Screen on page 218.
	UF Time – This is the value from the “Home” screen, see page 72 for more information. When a UF profile is selected and confirmed, the machine will apply the new UF profile to the remaining UF time in twelve equal segments.



Note: Any of the four customizable profiles (5 through 8) that are not programmed will function the same as the None profile. See “Creating Custom UF Profiles” on page 213 for instructions on how to customize these profiles.

To initiate an ultrafiltration profile, select one of the profiles by highlighting it with the Navigation Keypad and pressing the **CONFIRM** key. Enter the desired UF Goal and UF Time values using the numeric keys or the **+** or **-** (plus or minus) keys on the data entry keypad and confirming with the **CONFIRM** key. The UF Goal and UF Time values from the “Home” screen will appear in the “UF Profiles” subscreen. Once the UF Goal and UF Time are entered, the Maximum UF Rate for the selected profile is calculated and displayed in the corresponding text box on the screen.

To enter an ultrafiltration profile:

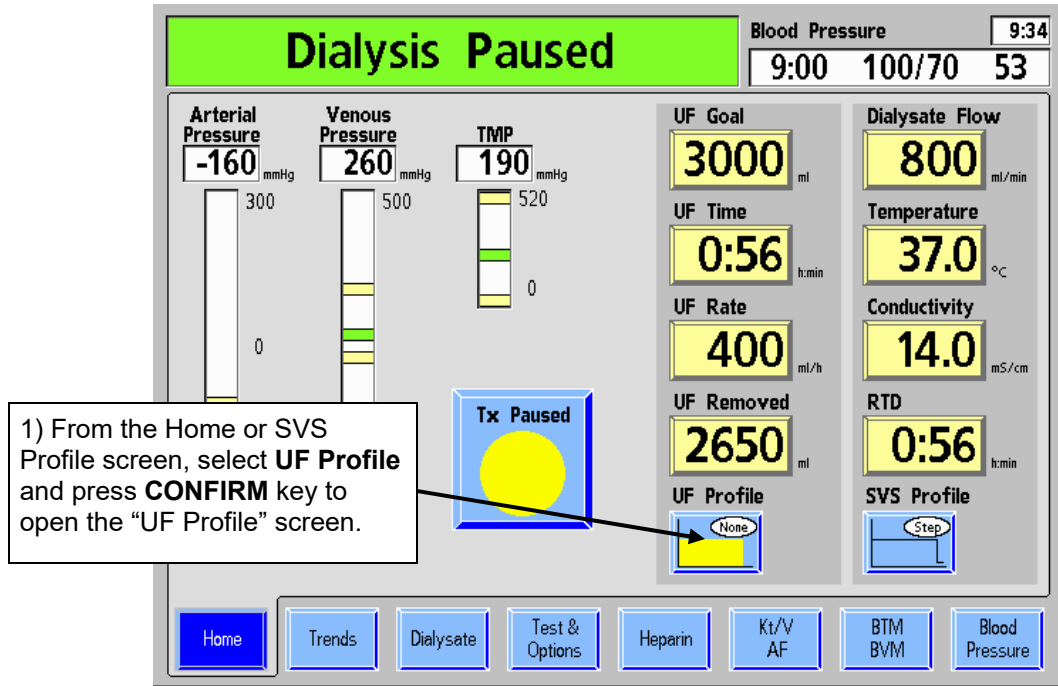

Figure 35 – Setting a UF Profile

SETTING PARAMETERS

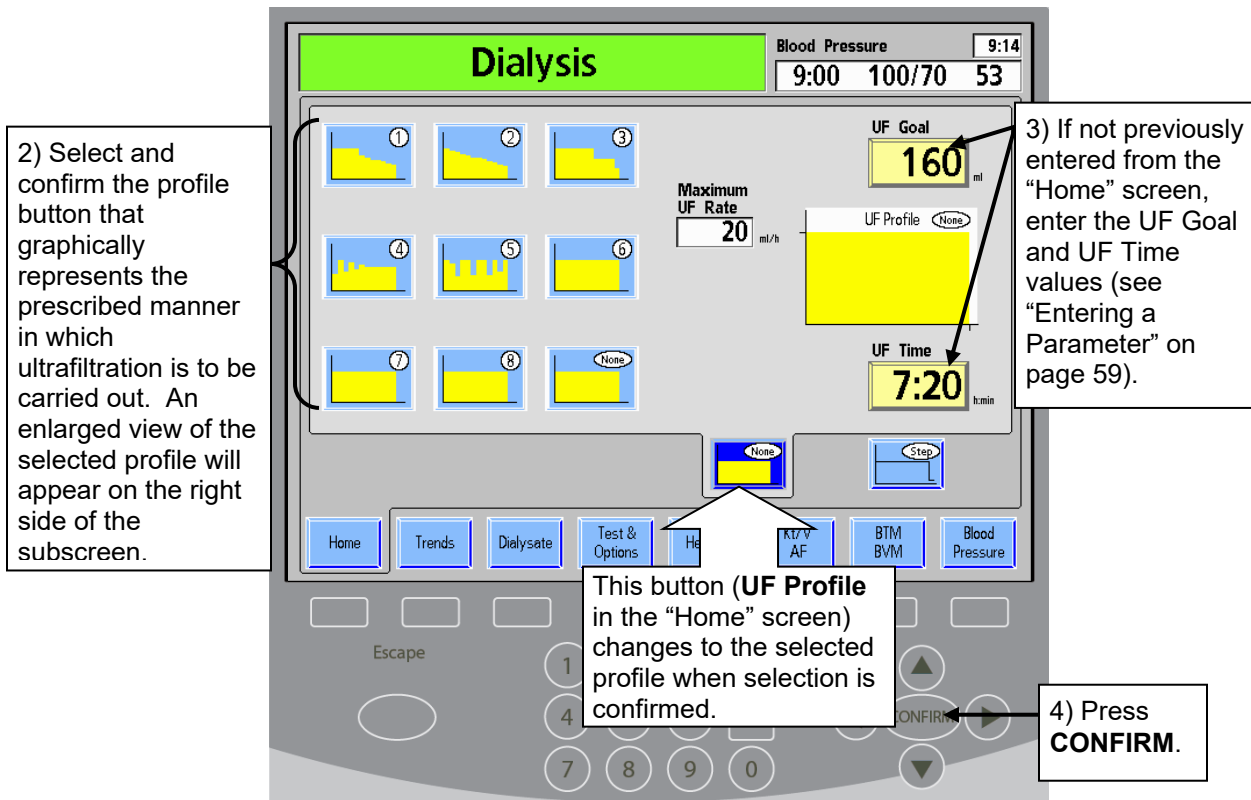

Figure 36 – Setting UF Profile Parameters



Note: The “None” profile performs ultrafiltration at a constant rate. It does not mean that no ultrafiltration will occur.

The maximum UF rate is displayed for the selected profile, UF Goal, and UF Time. If the maximum UF Rate is too high (beyond the configuration of the machine), a message appears in the Dialogue Box located in the upper, right corner of the screen. The operator has the option of increasing the UF Time, reducing the UF Goal, or selecting another profile.

To change the profile, select the corresponding profile button.

To change the time, select the **UF Time** button.

To change the UF goal, select the **UF Goal** button. The maximum ultrafiltration rate, based on the UF Goal, Time & Profile, will be calculated and displayed in the Maximum UF-Rate display.

When all ultrafiltration parameters are satisfactory, press **CONFIRM** to save the changes, then exit from the “UF Profile” screen. The machine will apply the new UF profile to the remaining UF time in twelve equal segments.

Isolated Ultrafiltration

Isolated Ultrafiltration (UF) is sometimes prescribed for patients suffering from excessive fluid retention. During Isolated UF the machine does not run dialysate through the dialyzer, it performs only ultrafiltration, pulling the patient’s excessive fluid from the bloodstream via the dialyzer with no diffusion.

Running Isolated UF as Sequential Dialysis

Isolated UF is performed using the “SEQ” (Sequential) setting on the “Home” screen’s **Dialysate Flow** button. Sequential dialysis refers to a two-stage treatment in which one of the stages consists solely of Isolated UF followed by hemodialysis. Using Sequential dialysis, Isolated UF is usually performed at the beginning of a standard dialysis treatment, although it can also be administered during treatment. The operator can start or stop the Isolated UF option at any time. After 60 minutes of Isolated UF, the machine will notify the operator that dialysate flow has been off for 60 minutes. At that time, the operator must choose to turn on dialysate flow and begin hemodialysis or to continue with Isolated UF

To set the 2008K² hemodialysis machine for sequential dialysis:

- 1) Set UF treatment parameters. Set the UF Time to include the combined treatment and Isolated UF times.
- 2) Turn off Dialysate Flow. The yellow light will flash when flow is off.
- 3) Make sure UF is on (the green light will be on).
- 4) Select **Dialysate Flow** to highlight it.
- 5) Use the number keys to enter 0 or scroll down to “SEQ” using **+/-** keys.
- 6) Press **CONFIRM**. This will deactivate the “Flow Off” warning for five minutes. The Dialysate Flow button will display “SEQ” and the dialysate Temperature button will display “N/A”.

Figure 37 – Setting Sequential Dialysis

After 60 minutes of Isolated UF, an alarm sounds and the warning message, “60 Minutes Flow Off,” appears in the Status Box. The operator has the option of continuing Isolated UF or starting hemodialysis. This alarm occurs only once.

- **To continue Isolated UF**, press the **RESET** key on the left side of the control panel. This will silence the alarm and clear the warning message. Isolated UF will continue for the rest of the prescribed treatment time or until dialysate flow is turned back on.
- **To start the treatment**, select the **Dialysate Flow** button in the “Home” screen, set it to the prescribed rate using the data entry keypad, press **CONFIRM**, and start the dialysate flow by pressing the **Dialysate Flow on/off** key in the upper, right corner of the control panel. When dialysate flow is on, the yellow light is not illuminated. The machine will go into bypass mode until dialysate temperature and conductivity settings are attained (about two minutes). Hemodialysis will run for the rest of the prescribed treatment time.



Note: Dialysate flow must be re-established for a minimum of five minutes before resuming Isolated UF or the warning will reoccur.

Sodium Variation System



Note: If the SVS option is set to ‘No’ in Service Mode, the Sodium Variation System is not available.

Physicians may prescribe additional sodium in the dialysate to assist in the prevention of hypotension, cramping, and disequilibrium syndrome. The Sodium Variation System (SVS) option provides the operator with an automated method of changing the concentration of dialysate sodium in accordance with the physician’s prescription.

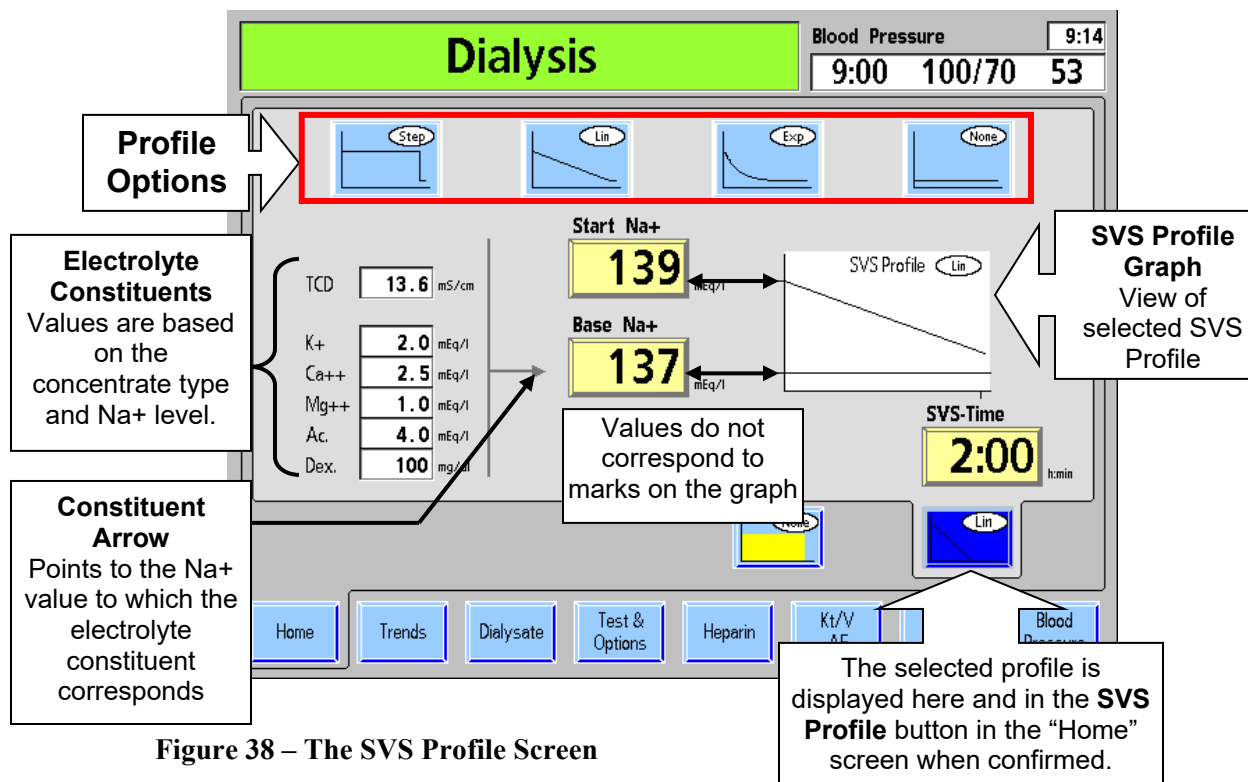

Figure 38 – The SVS Profile Screen





The Sodium Variation System (SVS) allows the standard dialysis treatment to be modified so that the acid/acetate concentrate, which contains most of the sodium in the dialysate, is varied according to a specific profile. There are three basic profiles available: Step, Linear, and Exponential, or the operator may select None. In each profile, a higher level of sodium (Start Na⁺) is set initially. By the end of SVS operation, the sodium level is back to the Base level. Selecting None maintains the sodium at the Base level through the course of the treatment. The default profile is None.

The following table describes the buttons on the “SVS” subscreen that facilitates the implementation of the SVS.

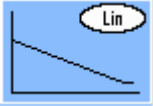

Note: The constituents concentration is recalculated each time the + or – (plus or minus) key is pressed. If the Na or Bicarbonate level is entered with a numeric key, they are only recalculated after the **CONFIRM** key is pressed or a parameter button is selected for a different parameter.

Table 17 – The SVS Subscreen Buttons

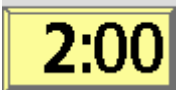
Button	Function
	<p>Step Profile – Once stable base conductivity has been achieved, selecting this program will initiate the increase in dialysate sodium. The dialysate sodium will rise to the program peak sodium level (Na⁺). The dialysate sodium will remain at this level for the duration of the program time. When the program time has elapsed, the dialysate sodium will drop back down to the baseline sodium level.</p>
	<p>Linear (Lin) Profile – Once stable base conductivity has been achieved, selecting this program will initiate the increase in dialysate sodium. The dialysate sodium will rise to the program starting peak sodium level (Na⁺). From this point, the dialysate sodium will decrease toward the baseline sodium level in a straight diagonal line. This drop will occur over the duration of the program time. When the program time has elapsed, the dialysate sodium will be at the baseline sodium level.</p>
	<p>Exponential (Exp) Profile – Once the stable base conductivity has been achieved, selecting this program will initiate the increase in dialysate sodium. The dialysate sodium will rise to the program's starting peak sodium level (Na⁺). From this point, the dialysate sodium will decrease over the program time, toward the base sodium level in a smooth curved line. When the program time has elapsed, the dialysate sodium will be back at the baseline sodium level.</p>
	<p>None – The level of sodium set in the Base Na⁺ button is maintained throughout the treatment, with <u>no</u> variations. It does not mean that no sodium will be used.</p>
<p>Start Na+</p> 	<p>The prescribed peak sodium level that will be set at the beginning of the SVS Profile is accessed here. This value has an allowable range from base Na⁺ to 155 mEq/L. The value displayed corresponds to the upper tick mark on the vertical axis of the profile graph. This button will appear grayed out if the None profile is selected.</p>
<p>Base Na+</p> 	<p>The prescribed base sodium level of the dialysate can be viewed here or in the “Dialysate” screen. The Base Na⁺ has an allowable range of 130 to 155 mEq/L. This value corresponds to the lower tick mark on the vertical axis of the profile graph.</p>
<p>SVS-Time</p> 	<p>This button is used to access the program time length in hours and minutes (0:00 to 9:59) prescribed for SVS operation. Once the SVS is started, it functions as a count down timer displaying the time remaining in the SVS program. The end time is represented in the profile graph by a tick mark on the horizontal axis.</p>

To set an SVS profile:

SETTING PARAMETERS

1) From the “Home” screen, select the **SVS Profile** button and press **CONFIRM**. The SVS Profile window opens.

2) Use the Navigation Keypad to select the prescribed profile from among the four options located in a row along the top of the screen then press **CONFIRM**.

3) Select **Start Na+**, and enter the starting maximum Na value using the data entry keypad on the control panel.

4) Select **Base Na+**, and, using the data entry keypad, enter the final Na concentration value to be reached at the end of the SVS profile.

5) Select the **SVS Time** button and, using the data entry keypad, enter the running time for the SVS profile.

6) Press **CONFIRM** to save the SVS settings.

Figure 39 – Entering an SVS Program

The SVS timer is activated when the **Tx Clock** button is initially selected and confirmed to start treatment. The green light located above the **SVS on/off** key will illuminate. The SVS profile parameters can only be changed if the SVS is turned off using the **SVS on/off** key.



Note: During the SVS program, the actual conductivity bar, shown in bar graph on the Dialysate screen, should be centered in the alarm window. This may require shifting the position of the upper and lower alarm limits using the **Alarm Position** button. See “Conductivity Limits” on page 69.



Note: If any SVS parameter is changed after the program has started (SVS must be turned off to change), a new SVS program is initiated with the displayed SVS time and SVS start Na.

The Electrolyte Constituents

The acid concentrate is the major source of electrolytes in the dialysate. Increasing the Na⁺ concentration in the dialysate, therefore, increases the amount of acid concentrate.

Increasing the amount of acid concentrate also increases the concentration of the other electrolytic constituents. These changes can be observed in the electrolyte constituents shown in the left side of the “SVS Profile” subscreen.

To observe the electrolyte constituents for the higher concentration of sodium, select **Start Na⁺**. The values in the left column change to reflect the increased sodium (see Figure 38 on page 80). Select **Base Na⁺** to observe the constituents at the base concentration. The arrow indicates which of the Na⁺ concentrations corresponds to the values. If neither button is highlighted, the electrolyte constituents values default to the Base Na⁺ setting, as indicated by the arrow.

Operation

Once the SVS program is started, the maximum sodium level (Start Na⁺) is reached after about three minutes. The theoretical conductivity (TCD) will immediately adjust to the expected conductivity for the selected Na⁺ level. As the actual conductivity rises, the alarm window will also track upward, to within the maximum conductivity alarm window limit of 0.5 mS/cm above TCD. While the alarm window is rising, the TCD may be outside of the alarm limits. The machine, however, may not be in an alarm state because the limits are tracking the actual conductivity. After the tracking is complete, the alarm window moves automatically to the expected conductivity based on the selected parameters and starting alarm limits. The SVS Time starts counting down when the Start Na⁺ level is reached.

If an SVS program is in progress, pressing the **SVS on/off** key on the control panel will pause the program. The conductivity will return to the Base Na⁺ level and the SVS-Time countdown stops. Alarms may occur as the conductivity stabilizes. The operator has two options:

- Restarting the program by pressing the **SVS on/off** key on the control panel. The **SVS-Time** and **Start Na⁺** may need to be adjusted.
- Terminate the program by selecting the **SVS Time** button on the “SVS Profile” subscreen, entering zero using the data entry keypad, and pressing **CONFIRM** or by changing profile to “None” and pressing **CONFIRM**.

Heparin Screen Settings

The “Heparin” screen settings control the 2008K² heparin pump operation. It can be set to deliver heparin in a bolus dose and at a consistent rate during the treatment.

What to set in this screen...

- The Syringe (manufacturer and size)
- Delivery Rate
- Infusion Time
- Bolus Dose (if administered)

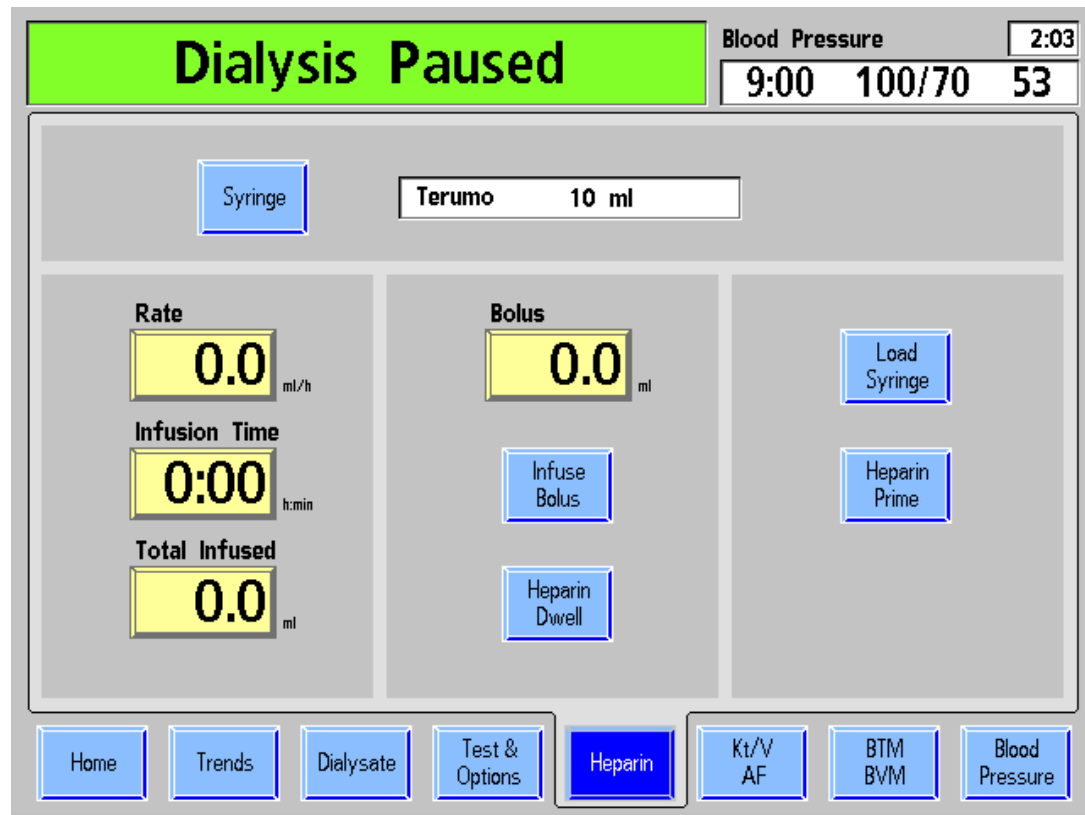

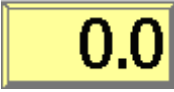

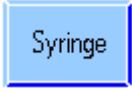
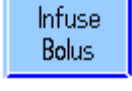





Figure 40 – The Heparin Screen

Table 18 – Heparin Screen Buttons

Button	Function
<p>Rate</p> 	The Rate button displays the rate at which heparin is dispensed during treatment. It can be set from 0.0 to 9.9 ml/hour.
<p>Infusion Time</p> 	The Infusion Time button displays the amount of time in hours and minutes that the heparin pump will deliver heparin. The program time can be set from 0 to 9:59. For the heparin pump to stop at a desired time automatically, the operator must set an Infusion Time. When the heparin pump is On, this time will count down to 0:00 and stop heparin delivery. Infusion Time can be set to zero only when the heparin pump is Off.
<p>Total Infused</p> 	The Total Infused button displays the current total amount of heparin delivered by the heparin pump (including the bolus). Total Infused can be reset to 0 with the numeric keypad or +/- keys and pressing the CONFIRM key when the Heparin pump is Off.
<p>Bolus</p> 	The amount of heparin to be delivered as a bolus infusion is entered here. The heparin pump delivers the bolus infusion at a rate of about 0.17 ml/sec (1 ml/6 seconds) for a 10 cc syringe. This amount can be set from 0.0 to 9.9 ml. During delivery, the Bolus amount is added to the amount shown in the Total Infused button.
	The Syringe button opens a menu listing various syringe types. The operator selects the syringe matching the one that will be used during treatment.
	The Infuse Bolus button activates the heparin delivery system to administer the amount of heparin displayed in the Bolus button. Once activated, the actual delivery is accomplished by pressing CONFIRM . Afterwards, the heparin pump will infuse heparin at the rate displayed in the Rate button.
	Selecting the Load Syringe button, followed by the CONFIRM key, fully retracts the heparin pump carriage to allow the mounting of the syringe in the pump. Pressing the Escape key will stop the travel of the carriage.
	The Heparin Prime button initiates a process to fill the Heparin line. Once a syringe is mounted in the pump, press the Heparin Prime button, followed by the CONFIRM key. The syringe plunger is pushed upward into the barrel while the CONFIRM key is pressed.
	The optional Heparin Dwell button (enabled in Service Mode) acts as a five minute timer after a manual heparin bolus is administered. To use the timer, select the Heparin Dwell button and press the CONFIRM key. This will cause the optional 'Traffic Light Status Beacon' on the IV pole to flash yellow at half-second intervals for five minutes while the heparin is dwelling. After the five minutes has elapsed, the Status Box will display the message, "Heparin Dwell Complete," and the 'Traffic Light Status Beacon' on the IV pole will turn green and continue to flash until the operator presses the RESET key.



Warning! If no time is set in the **Infusion Time** button and the heparin pump is turned on, it will run at the selected rate until the syringe is empty or the heparin pump is turned off. The heparin pump should be monitored to verify the intended infusion during treatment.

Table 19 – Control Panel Heparin on/off Key

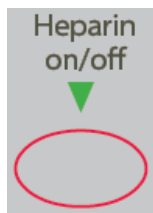
Key	Function
	<p>The Heparin on/off key activates the heparin administration program. It is located on the lower, right side of the control panel. The green light above the button is illuminated when the pump is running.</p> <p>When the light is flashing, the operation is interrupted and will resume when the Treatment Clock is turned on or the Heparin on/off key is pressed.</p> <p>If the Heparin on/off key is pressed to turn off the pump, the light will turn off and the pump will not resume with the Treatment Clock button.</p>

The Heparin Delivery System



Warning! The correct syringe type must be selected to ensure an accurate infusion.

To prepare the heparin delivery system using the features on the “Heparin” screen:

1) Fill the syringe selected from the menu with the prescribed amount of heparin for the entire treatment.

2) In the “Heparin” screen, select **Syringe** and press **CONFIRM**. The syringe menu opens.

3) Use the **+/-** keys on the data entry keypad to scroll the drop-down menu until the correct syringe type is highlighted.

4) Press **CONFIRM**.

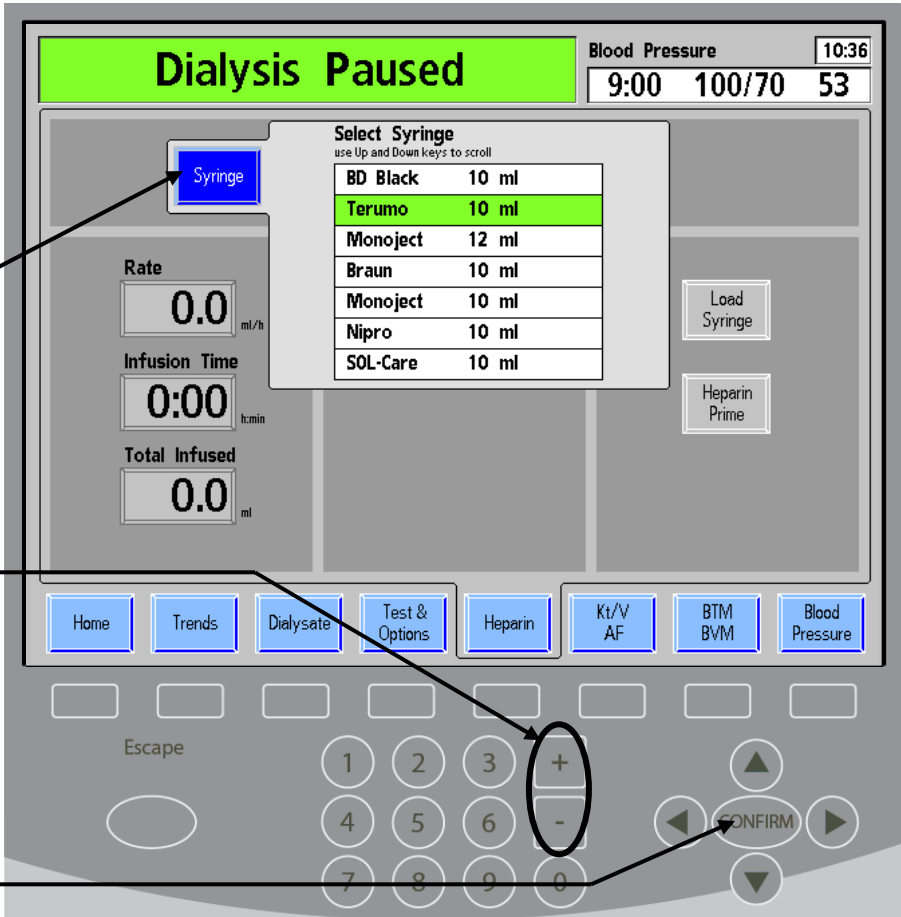

Figure 41 – The Syringe Subscreen on the Heparin Delivery Screen

5. Select the **Load Syringe** button, then press the **CONFIRM** key. The heparin pump carriage fully retracts.



Warning! Make sure that there is sufficient heparin for the bolus and subsequent heparin infusion. Do not load the syringe beyond the prescribed amount.

6. Pull back one of the barrel lock tabs and press the barrel of the syringe into place. Slide the barrel wings of the syringe into the wings slot on the pump module. With the barrel in place, release the barrel lock tab (see Figure 42).
7. Squeeze the carriage latch to open the plunger holder and allow the carriage assembly to move freely. To prevent backup of blood into the syringe, be sure to slide the carriage upward until it is firmly seated against the syringe plunger.
8. Release the carriage latch and allow the plunger lock tabs to clamp the plunger in place securely.

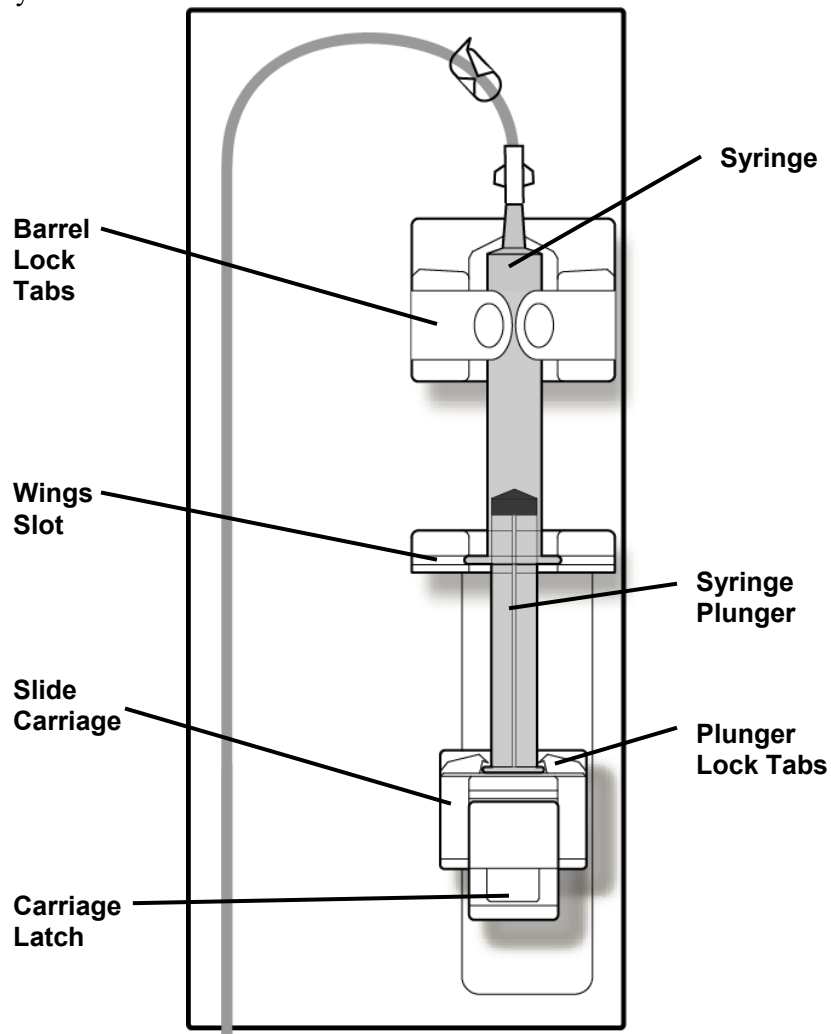

Figure 42 – The 2008K² Heparin Pump Module with Syringe Loaded and Connected

9. Connect the syringe to the heparin line and unclamp the heparin line.
10. Select the **Heparin Prime** button, then press and hold the **CONFIRM** key. As the carriage moves upward, observe the heparin as it travels from the syringe through the heparin line.
11. When the air has been cleared from the heparin line, release the **CONFIRM** key. The pump will stop.



Warning! Clamp the heparin line closest to the “T” connection during recirculation if using reuse dialyzer.

12. In the “Heparin” screen, set the treatment parameters for Rate, Infusion Time, and Bolus as described in Figure 40 – The Heparin Screen on page 84.

The heparin administration system is now ready for patient treatment.



Warning! The heparin pump is to be used only under positive pressure conditions. Under negative pressure conditions, excessive heparin may be infused.

Test & Options Screen Settings

The “Test & Options” screen is divided into two distinct sections. The left side of the screen is used to initiate the self test and show the results (see Chapter 2, “Testing the 2008K² Hemodialysis Machine”). The right side of the screen is available to set the machine for various treatment options. Refer to the table below for descriptions of the purpose and functions of each button.

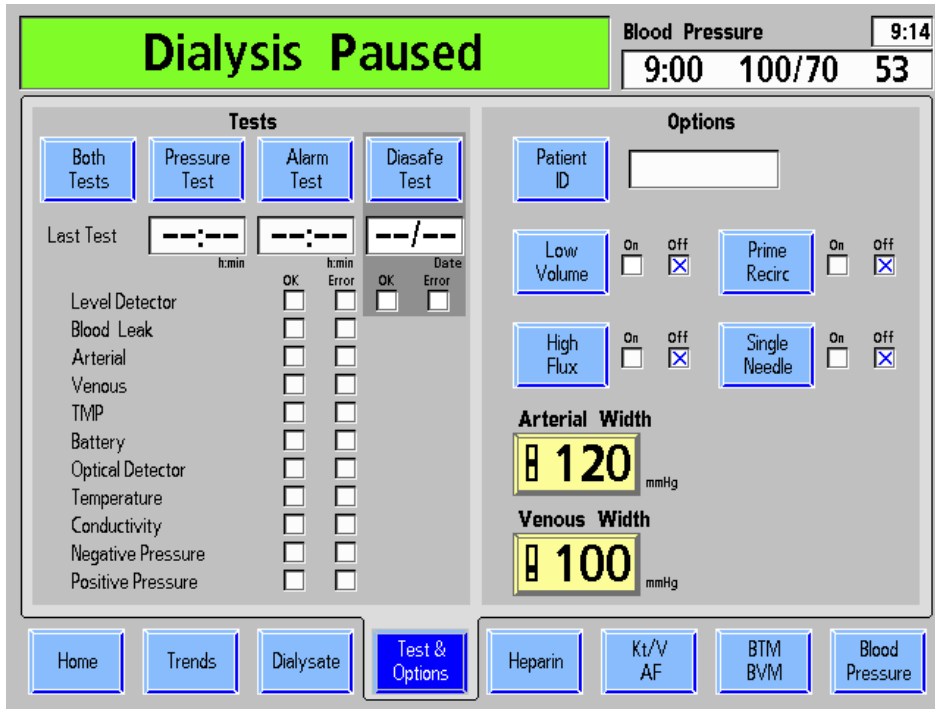







SETTING PARAMETERS

Figure 43 – The Test & Options Screen

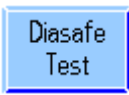
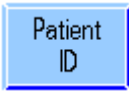
The following table describes the operator-programmable features in the “Test & Options” screen.

Table 20 – Test & Options Screen Buttons

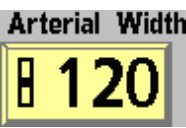
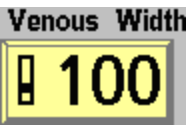
Button	Function
Both Tests	This test will initiate both the pressure holding tests (PHT) and the alarm test functions.
Pressure Test	The user can choose to do a Pressure Holding Test with this button.
Alarm Test	The user can choose to do the Alarm Test with this button.

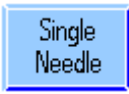
Button	Function
	If the machine is set up with an automatic test valve, the user can choose to do the Diasafe Test with this button.
	Selecting the Patient ID button opens an on-screen keyboard that is used to enter a patient's ID in the text box located to the right of the button. The 2008K ² hemodialysis machine can upload treatment information to a network database for review by clinical staff using a personal computer.
	<p>The Low Volume button activates treatment settings specific to patients weighing between 20 and 40 kilograms (44 to 88 lbs.). The selection is indicated by an X in the On or Off box.</p> <p> Note: The Low Volume button is temporarily unavailable (grayed-out) if a blood pressure reading is in progress. After the reading completes, the option will once again be available to set. This button is unavailable to set if blood is sensed or the Tx Clock is running.</p> <p>The Low Volume button will also be unavailable for the rest of the treatment if any UF parameter has already been changed (UF Goal, UF Time, UF Rate) or if the UF Removed button is not zero. To set the 'Low Volume' option, press and confirm the New Tx key to initiate a new treatment. The option will also become available again after performing a long power down or running a rinse program.</p>
	<p>The High Flux button selects parameters for the use of a high flux dialyzer for treatment. The selection is indicated by an X in the On or Off box.</p> <p> Warning! It is essential that the 2008K² hemodialysis machine balancing system is operating properly when using high-flux dialyzers. The machine must successfully complete a Pressure test before treatment commences. For more information, See "Testing the 2008K² Hemodialysis Machine" on page 52.</p>
	<p>The Arterial Width button allows the selection of three different ranges for the arterial pressure alarm (120, 160, and 200 mmHg).</p> <p>Note: These options will only be available if set to "User Selectable" in the Service Mode "Options" screen.</p>
	<p>The Venous Width button allows the selection of four different ranges for the venous pressure alarm (100 asymmetric limits, 120, 160, and 200 mmHg). The asymmetric limit will close the lower venous limit after a time delay for stabilization.</p> <p>Note: These options will only be available if set to "User Selectable" in the Service Mode "Options" screen.</p>
	Runs the UF pump at preselected UF goal and time while recirculating. UF goal and Time are entered in the Service Mode.
	The Single Needle button prepares the machine for single-needle dialysis treatment. For more information on single-needle dialysis treatment, see Appendix A.

Low Volume Dialysis

The Low Volume option is for patients weighing between 20 and 40 kilograms (44 to 88 lbs.). This option automatically lowers blood pressure cuff ranges, pressure monitoring ranges, UF rates, and blood flow rates, and it restricts the allowable blood pump segment sizes to less than 8 mm, see Table 21 below for more information.



Warning! When using Low Volume bloodlines, the blood pump must be set for the correct inner diameter of the pump segment.

Table 21 – Low Volume Settings

Available Blood Pump Segments	Blood Flow Rate
2.6 mm	6 – 86 ml/min
4.8 mm	10 – 274 ml/min
6.35 mm (displayed as 6.4)	20 – 465 ml/min
Blood Pressure Alarm Limits	Range
Systolic (upper)	90 – 160 mmHg
Systolic (lower)	70 – 130 mmHg
Diastolic (upper)	60 – 100 mmHg
Diastolic (lower)	40 – 80 mmHg
Pulse (upper)	80 – 200 BPM
Pulse (lower)	40 – 180 BPM
Cuff Inflation Pressure	120 – 210 mmHg, default Auto setting begins at 120 mmHg and for subsequent measurements inflates to approximately 30 mmHg above last systolic reading
Blood Circuit Pressure	Monitoring Range
Arterial	-260 to +300 mmHg with 3 automatically set alarm limit window widths (± 40 , ± 60 , and ± 80) mmHg centered around set pressure (Single Needle ± 80 mmHg)
Venous	-60 to +300 mmHg with 3 fixed window limit values of ± 40 , ± 60 , and ± 80 mmHg of set pressure (Single Needle ± 80 mmHg)
Ultrafiltration	Range
UF Rate	0 – 1000 ml/hr, default 30 ml/hr
Maximum UF Rate (set in Service Mode)	500, 600, 700, 800, 900, or 1000 ml/hr

To set the ‘Low Volume’ option: select the **Low Volume** button on the “Test & Options” screen, press the **CONFIRM** key, then press the round left arrow key on the Navigation Keypad until a gray X appears in the ‘On’ check box. Press the **CONFIRM** key again to confirm the selection. A blue X will appear in the ‘On’ check box next to the button when the option is selected. The blood pressure module utilizes a lower, initial-inflation pressure when the Low Volume option selected (see “Blood Pressure Module” under “Machine Specifications”).

Blood Pressure Screen Settings

The “Blood Pressure” screen works in conjunction with the blood pressure module. The operator sets the inflation pressure of the cuff, the frequency at which the tests are to be performed, and the upper and lower limits for the various blood pressure and pulse alarms. The Blood Pressure Module automatically takes the patient’s blood pressure at each set interval. The pulse and blood pressure readings are both displayed in a table on the left side of the “Blood Pressure” screen (see Figure 44 on page 92). The blood-pressure history is also graphically displayed here and in the “Trends” screen. The time and results of the last blood pressure reading is always available in the Dialogue Box located in the upper right corner of any screen.



Note: Only readings taken while the Tx Clock is running will be displayed on the graph. All readings will be shown in the table. If a blood pressure reading is started manually with the **Stat/Deflate** key, the reading will be preceded with “M” in the data table.

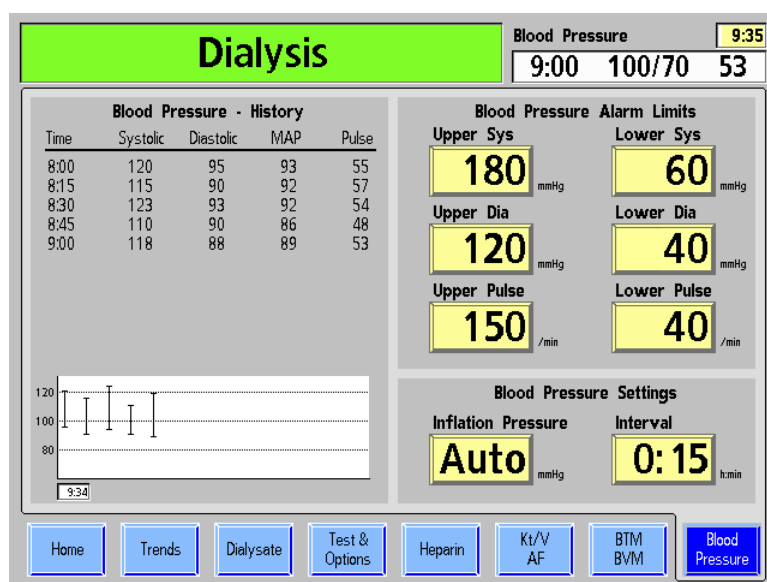

Figure 44 – Blood Pressure Screen

The blood pressure alarm limits are set in the upper, right side of the screen. The upper and lower alarm limits for pulse rate and systolic and diastolic blood pressures are set here. If a pressure value is outside the set alarm limits, the machine sounds a series of short, intermittent beeps.

The lower right portion of the screen contains two buttons for setting the inflation pressure of the cuff, and the frequency at which it will inflate.



Caution: Do not squeeze the blood pressure cuff when deflating it. Squeezing the blood pressure cuff may damage the machine's internal blood pressure module.











Note: The blood pressure module is not designed to replace the periodic observation of the patient by the clinical staff. The clinical staff should review all blood pressure readings.

Blood Pressure Screen Buttons

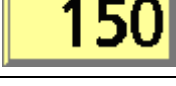
The following table contains a list of treatment parameters to set in the “Blood Pressure” screen. To enter a treatment parameter, see “Entering a Parameter” on page 59.

Table 22 – The Blood Pressure Screen Buttons

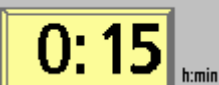
Button	Function
Upper Sys 	The Upper Sys button is used to set the upper alarm limit for systolic blood pressure. The programmable range for Upper Systolic is 80 – 250 mmHg for standard patients and 90 – 160 mmHg for Low Volume patients. An alarm event occurs when the patient’s systolic pressure reaches or exceeds the set value.
Lower Sys 	The Lower Sys button is used to set the lower alarm limit for systolic blood pressure. The programmable range for Lower Systolic is 60 – 150 mmHg for standard patients and 70 – 130 mmHg for Low Volume patients. An alarm event occurs when the patient’s systolic pressure reaches or falls below the set value.
Upper Dia 	The Upper Dia button is used to set the upper alarm limit for diastolic blood pressure. The programmable range for Upper Diastolic is 80 – 200 mmHg for standard patients and 60 – 100 mmHg for Low Volume patients. An alarm event occurs when the patient’s diastolic pressure reaches or exceeds the set value.
Lower Dia 	The Lower Dia button is used to set the lower alarm limit for diastolic blood pressure. The programmable range for Lower Diastolic is 40 – 150 mmHg for standard patients and 40 – 80 mmHg for Low Volume patients. An alarm event occurs when the patient’s diastolic pressure reaches or falls below the set value.
Upper Pulse 	The Upper Pulse button is used to set the upper alarm limit for pulse rate. The programmable range for Upper Pulse is 80 – 200 beats/min for both standard and Low Volume patients. An alarm event occurs when the patient’s pulse rate reaches or exceeds the set value.
Lower Pulse 	The Lower Pulse button is used to set the lower alarm limit for pulse rate. The programmable range for Lower Pulse is 40 – 140 beats/min for standard patients and 40 – 180 beats/min for Low Volume patients. An alarm event occurs when the patient’s pulse rate reaches or falls below the set value.

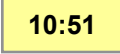
Button	Function
<p>Inflation Pressure</p> 	<p>The Inflation Pressure button is used to set the initial inflation pressure for the blood pressure cuff.</p> <p>The default setting is “Auto” in which the cuff will initially inflate to 180 mmHg for standard patients and 120 mm Hg for Low Volume patients. For all subsequent readings, the cuff will inflate to approximately 50 mmHg above the last systolic pressure reading for standard patients and approximately 30 mmHg for Low Volume patients.</p> <p>The minimum inflation pressure setting is 120 mmHg for both standard and Low Volume patients. The maximum inflation pressure setting is 280 mmHg for standard patients and 210 mmHg for Low Volume patients.</p>
<p>Interval</p>  <p>Clock Time</p> 	<p>The Interval/Clock Time button is used to set the frequency (hr:min) at which the patient’s blood pressure will be read and recorded.</p> <p>This interval may be set up in the Service Mode in one of two ways:</p> <ul style="list-style-type: none"> • Interval – Blood pressure readings are taken at the selected interval time between readings based on the start of treatment. If this option is selected, the heading over the button will read “Interval”. • Clock Time – Blood pressure readings are taken every 5, 10, 15, 20, 30, or 60 minutes based on the local time (see below). If this option is selected, the heading over the button will read “Clock Time”.
	<p>On the “Blood Pressure” screen only, the local time may be set by selecting the clock in the upper right corner of the Dialogue Box. The + or - (plus or minus) keys on the control panel may be used to change the time.</p>



Note: Using cuff tubing longer than 10 feet may result in erroneous blood pressure readings.

Starting Dialysis

At this point, all treatment parameters and options should be entered. Dialysate should already be verified for absence of disinfectant, verification of prescription, conductivity, and pH should also be confirmed. It is now time to connect the patient to the 2008K² hemodialysis machine via the blood tubing and begin the dialysis treatment.



Note: Follow established unit protocol regarding procedures for establishing aseptic blood connections.

1. Before starting dialysis, complete the patient assessment per unit policy.
2. Wrap the blood pressure cuff around the patient's non-access arm.



Warning! Be sure the cuff is the correct size and placed at heart level. An improperly fitted cuff may cause inaccurate blood pressure readings due to under or over compression of the brachial artery. Each centimeter above or below heart level will cause an error of ± 0.8 mmHg.

3. Verify that ultrafiltration is off (UF light is off), and that the **UF Removed** button is reset to zero. The UF removed may be reset by selecting the **UF Removed** button and then the 0 key and confirming the change.
4. Verify that the venous line is in the venous clamp and the optical detector. Verify that the optical detector door is closed.



Warning! Do not infuse the recirculated saline prime into the patient. Discard the recirculated saline and fill the extracorporeal circuit with fresh saline prior to connecting to the patient. The volume of fresh saline used to fill the extracorporeal circuit should be equal to the volume of the dialyzer and blood tubing set in use.

5. Lower the blood pump rate to 150 ml/min and then press the blood pump **Start/Stop** key to stop the pump.
6. Connect the patient and initiate treatment according to unit protocol.



Warning! Check all bloodline and dialysate line connections for fluid leaks. Keep access sites uncovered and monitored. Improper bloodline connections or needle dislodgements can result in excessive blood loss, serious injury, and death. Machine alarms may not occur in every blood loss situation.

7. Start the blood pump and adjust the blood flow rate to establish dialysis and the alarm limits. Establish the prescribed blood flow rate.
8. Rotate the dialyzer to arterial inlet up.
9. Select the **Tx Clock** button and press **CONFIRM** to start the treatment.
10. Check that the UF/SVS/Heparin are on, if prescribed. If applicable, a blood pressure measurement is initiated.



Warning! When establishing blood flow, ensure that air will not be infused into the patient.

Warning! Check all bloodlines for kinking. Improper blood flow may cause hemolysis of the blood.

Monitoring the Treatment

Several of the treatment screens available on the 2008K² hemodialysis machine are particularly useful for monitoring some aspects of the patient's condition and the effectiveness of the treatment. These screens are the:

- Home screen
- Trends screen
- Kt/V AF screen
- BTM/BVM screen
- Blood Pressure screen

The “Home” screen provides a general overview of the status of the current treatment. The other screens offer a more in-depth view of specific aspects of the treatment. It should be noted, however, that certain treatment data are presented in more than one screen.



Note: The 2008K² hemodialysis machine is equipped with both visual cues and audible alarms to alert the operator to potential problems. In every alarm condition, assess the patient for any changes in his/her physiologic state. Ensure that the patient's access is exposed and all connections in the extracorporeal circuit are secure and visible during the entire procedure. It is the responsibility of the dialysis personnel to provide safe and effective dialysis treatment. Document all atypical events.



Warning! When initiating dialysis therapy with the dialysis machine, it is important to check your dialysate flow status. Flows must be set to the prescribed flow rate. The **Dialysate Flow on/off** key is provided for Sequential Ultrafiltration and must be used only when prescribed. Treatment without dialysate flow may result in patient injury due to minimal removal of waste products in the patient's blood.

Warning! Turning the dialysate flow off when using a reused dialyzer may allow the chemical disinfectant to rebound (increase) to an unacceptable level.

Warning! Keep bloodline/catheter or needle connection visible. Do not cover the access site, e.g. with a blanket.



Caution: If it becomes necessary to replace the concentrate jugs during treatment, turn the dialysate flow off before attempting to do so to avoid drawing air into the system. Drawing air into the system can cause the concentrate pumps to malfunction.

Home Screen Monitoring

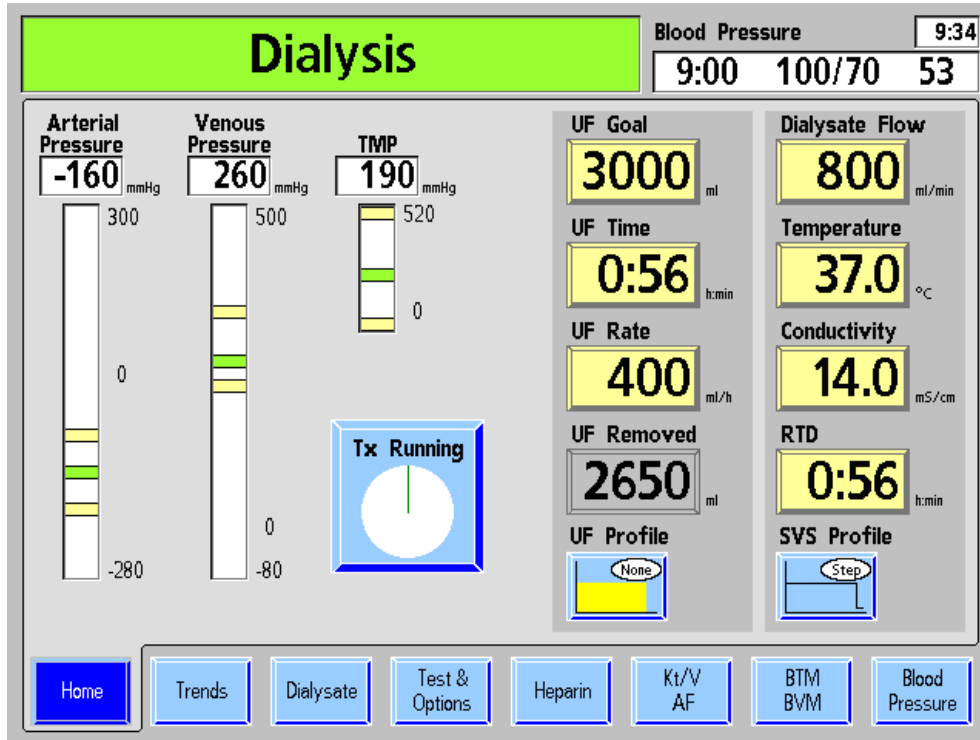





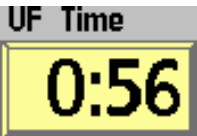

MONITORING TREATMENT

Figure 45 – Treatment Monitoring using the Home Screen

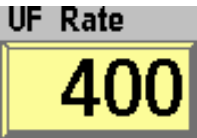
The “Home” screen provides an up-to-the-minute view of the status and progress of the treatment. The flow rate, temperature, and conductivity of the dialysate, the status of the ultrafiltration process, and the amount of treatment time left can all be found here. The following table describes the data provided by the buttons found in the “Home” screen.

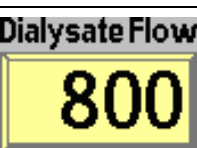
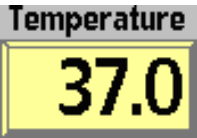
Table 23 – The Home Screen Buttons

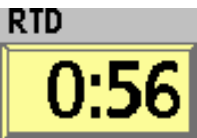
Button	Function
	Displays the desired UF to be removed during the treatment. This is typically the difference between the patient’s pre and dry weight plus saline or fluid intake during treatment.
	The UF Time button acts as a countdown timer displaying the remaining time ultrafiltration will be performed. The timer stops during a blood alarm or whenever the UF pump is stopped.

Button	Function
	<p>During treatment, this button displays the current rate of ultrafiltration in milliliters per hour (ml/hr). The rate ultrafiltration occurs is determined by the values entered in UF Goal and UF Time, and the UF Profile selected. UF Rate will automatically drop to 70 ml/hr when the UF Goal is achieved (or 300 ml/hr if the high flux option in the “Test & Options” screen is selected), or when blood flow is ≤ 90 ml/min. The rate flashes when the UF pump is turned off and there is no ultrafiltration.</p>
	<p>This button keeps a running total of the fluid drawn from the patient through ultrafiltration. When the value displayed in UF Removed is equal to the value entered in UF Goal, an alarm sounds and the message, “UF GOAL REACHED” is displayed in the Status Box. Pressing the New TX key on the control panel resets this value to zero. A sample of the ultrafiltrate can be obtained via the UF Fluid Sample Port located adjacent to the bicarbonate rinse port. The UF Removed button can only be edited when Dialysis is paused.</p>
	<p>This button displays the current dialysate flow rate. If 1.5x or 2x (auto flow) is selected, the flow rate will be indicated as follows: a800. See “Using Auto Flow” on page 214 for more information.</p>
	<p>The current temperature of the dialysate. If the temperature varies or ± 2 °C from set point, this button turns red, an alarm sounds, a warning message is displayed in the Status Box, and dialysate goes into bypass. Selecting this button allows the desired temperature to be set.</p>
	<p>This button displays the current conductivity of the dialysate. Selecting and confirming this button during treatment will open the “Dialysate” screen. If the conductivity varies outside of the alarm limits, this turns the button red, an alarm sounds, a warning message is displayed in the Status Box, and dialysate goes into bypass</p>
	<p>RTD (Remaining Time of Dialysis) This button acts as a countdown timer displaying the amount of treatment time remaining. At the end of treatment, (RTD = 0:00) an alarm sounds and the message, “RTD ZERO” is displayed. Any alarm situation will stop the RTD countdown.</p>
	<p>The Tx Clock button is selected and confirmed to start or pause the treatment. The green segment of the pie chart represents the amount of treatment completed. The green segment grows as the treatment progresses. The circle will be completely green when RTD is equal to zero. During treatment, this button displays the message, “Tx Running.” Selecting and confirming this button will interrupt the treatment and the button will display the message, “Tx Paused.” When the treatment is paused, the green segment will change to yellow, the UF and heparin pumps stop and SVS program pauses, and the RTD, UF Time, and heparin Infusion Time buttons stop counting down. The sodium content of the dialysate remains at the profile level it was when the treatment was paused. The blood pump and the dialysate flow, however, remain running.</p>

Bar graphs on the Home Screen

The three bar graphs on the “Home” screen represent the various pressures associated with dialysis treatment. The first two bar graphs represent the pressures inside the arterial and venous drip chambers. The third bar graph—Transmembrane Pressure (TMP)—represents the opposing blood and dialysate pressures being exerted from opposite sides on the dialyzer membrane.



Warning! The pressure changes resulting from a line separation or needle removal may be too small for the system to detect. All connections must be properly secured and checked regularly. Access sites and connections should remain uncovered for monitoring.

Arterial Pressure

The arterial pressure is the measure of the pressure inside the arterial drip chamber. The arterial pressure is read by a transducer inside the blood pump module. The drip chamber and transducer are connected by way of a pressure line that runs from the arterial drip chamber to the blood pump’s arterial pressure port ($P_{Art.}$). A transducer protector is fastened over the pressure port to guard against contamination of the transducer in case of a fluid surge within the chamber.

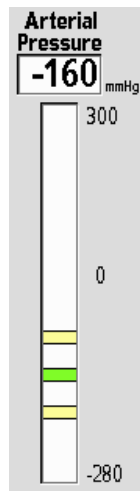

Arterial pressure is digitally displayed on the left side of the “Home” screen above a corresponding vertical bar graph. In the bar graph, under normal conditions, arterial pressure is represented by a green horizontal bar between two yellow bars that represent the upper and lower alarm limits. The area between the limits is the alarm window. The alarm limits are automatically set. When the arterial drip chamber is positioned before the blood pump in the extracorporeal blood circuit, the arterial pressure reading should be a negative value.

Unusually high or low pressures may be the result of kinks in the blood tubing, clotting, or a needle pressing against the vessel wall. Problems such as these may cause pressure readings to rise or fall outside the alarm window. When this happens, the arterial pressure bar changes from green to red, an alarm sounds, the blood pump stops, and venous line clamp closes. A warning message appears in the Status Box.

Alarms are not immediate and a variable time delay mechanism, dependent on the magnitude the pressure deviates outside the alarm window, allows for momentary minor changes in pressure. Adjusting the blood pump rate will cause the alarm limits to spread, allowing the pressure to stabilize before new limits are re-established.

Venous Pressure

The venous pressure is the measure of pressure inside the venous drip chamber. The venous pressure is measured by a pressure transducer located inside the level detector module. The

drip chamber and transducer are connected via a pressure line that runs from the chamber to venous pressure port ($P_{Ven.}$) located on the front of the module.

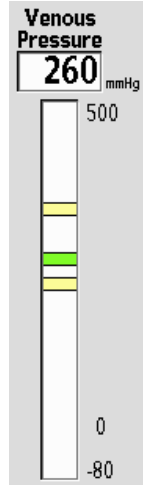

The venous pressure is represented in the same way as the arterial pressure, with the pressure digitally displayed in mmHg above a corresponding bar graph. In the bar graph, under normal conditions, the pressure is represented by a green horizontal bar between yellow bars representing the upper and lower alarm limits. During alarm conditions, when the pressure rises or falls outside the alarm window, the venous pressure bar changes from green to red. When alarm sounds and the blood pump stops, venous line clamp closes, and a warning message appears in the Status Box.

The alarm limits are set with a time delay for stabilization. Adjusting the blood pump rate will cause the alarm limits to spread and stabilize before new limits are established.

For 100 asymmetric limits, one minute after the alarm limits are centered the lower limit will close to within 20 mmHg to 35 mmHg of the actual venous pressure and the pressure limits will be activated. If in the course of the treatment, as the venous pressure increases, a clue to increasing viscosity from ultrafiltration, the alarm limits will be automatically re-centered and then closed after one minute every 30 minutes during the treatment. This is intended to keep the lower venous limit as tight as practical.

Increasing the blood pump rate will cause the alarm limits to spread in the appropriate direction temporarily, i.e., a higher blood pump rate will increase the venous pressure.



Warning! The low venous pressure alarm may not occur with every disconnection or needle dislodgement. Check all bloodlines for leaks after the treatment has started. Keep access sites uncovered and monitored. Improper bloodline connections or needle dislodgements can result in excessive blood loss, serious injury, and death. Machine alarms may not occur in every blood loss situation.



Note: When the optical detector senses blood, the minimum the lower venous pressure limit will be set to is + 9 mmHg.

Transmembrane Pressure (TMP)

The transmembrane pressure (TMP) is equal to the venous pressure minus the dialysate pressure measured in mmHg. On the 2008K² hemodialysis machine, the TMP is normally negative. Because the machine uses a closed, volumetric ultrafiltration system, the TMP is monitored primarily for detecting large shifts in pressure. In certain situations involving high-flux dialyzers, high blood-flow rate, or low UF rate, the TMP may approach 0 mmHg.

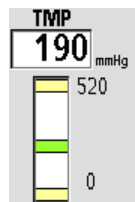

After a time delay for stabilization, the alarm limits are automatically set at ± 60 mmHg for conventional dialyzers, and ± 40 mmHg for high flux dialyzers. The alarm window automatically adapts for gradual increases in TMP caused by increasing blood viscosity resulting from ultrafiltration.



Warning! After starting dialysis, determine whether a stable TMP has been obtained and whether it corresponds to the ultrafiltration coefficient (KUF) of the dialyzer. TMP must be closely monitored with the alarm limits. The TMP may not change substantially during UF errors when high permeable dialyzers are in use. A fluctuating TMP, except in cases of single-needle dialysis, may indicate a malfunction in the balancing system. A high TMP may indicate a leak in the dialysate side of the system. Frequent Fill programs may indicate air in the balancing system. Some, but not all, UF errors can be checked by measuring the volumetric accuracy of the UF pump via the Fluid Sample Port using a graduated cylinder. If the cause cannot be corrected quickly, discontinue treatment.



Note: The approximate expected TMP can be calculated from the dialyzer blood ultrafiltration coefficient (KUF) and the UF rate:

$$\text{TMP} = (\text{UF Rate})/(\text{KUF})$$



Warning! When using highly permeable dialyzers, the dialysate side is frequently above atmospheric pressure (because of the venous pressure and low TMP). Although uncommon, any dialysate fluid leak from the dialysate side of the system will add to the intended ultrafiltration rate. Observe the system for fluid leaks and discontinue treatment if you are unable to correct any fluid leak quickly.

Trends Screen Monitoring

The “Trends” screen provides treatment status information similar to that found in the “Home” screen. The left side displays three graphs depicting the treatment progress of Clearance, SVS and UF profiles, and blood pressure history during the current patient’s treatment. The right side of the screen displays treatment summary data (see Figure 46).

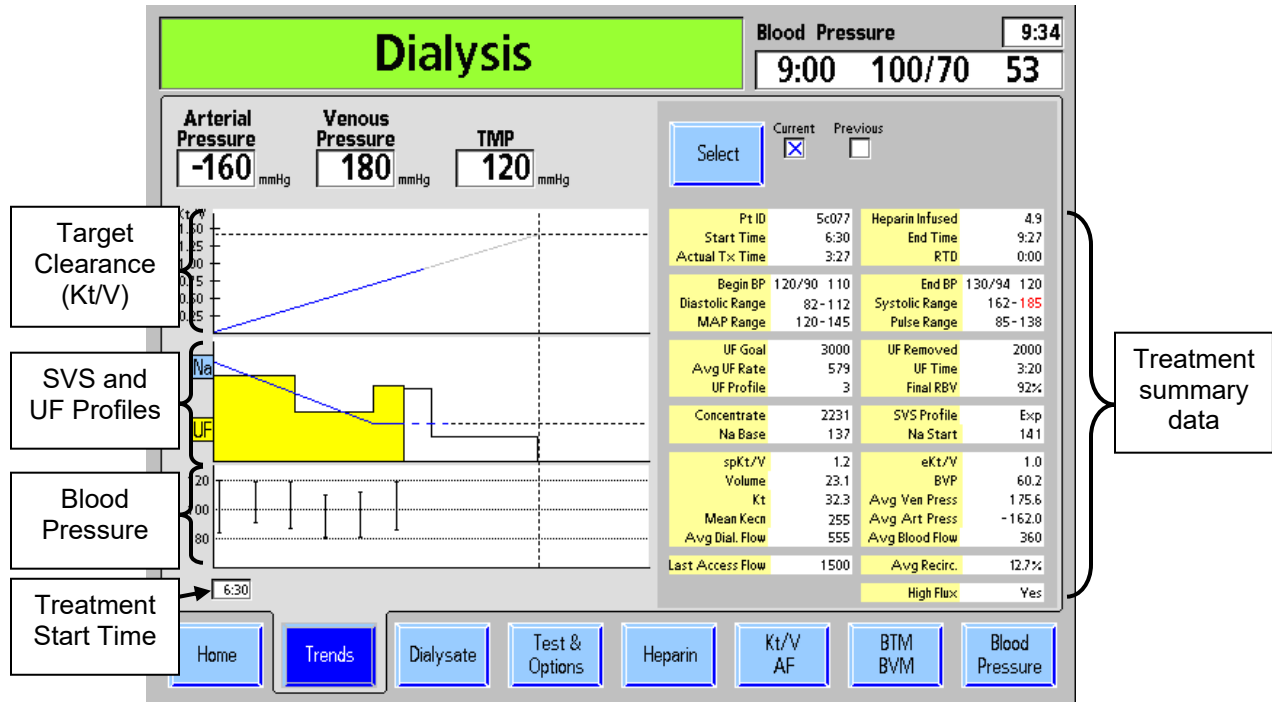

Figure 46 – The Trends Screen

These graphs provide information similar to those found in the Kt/V, Blood Pressure screens, SVS, and UF subscreens. Consolidating them here, along with the treatment summary information gives an overview of the entire treatment. If necessary, the treatment summary results from the prior treatment may be recalled.

Table 24 – The Trends Screen Buttons

Button	Function
	This button is used to display either the current or previous treatment summary data.

The following is information about each of the information lines in the treatment summary display.

Table 25 – The Treatment Summary Information

Display	Description
Pt ID	This is the patient ID. Currently this is only used by the FDS08 system.
Hep. Infused	This is the amount of heparin infused to the patient at this point in time (ml).
Start Time	This is the clock time when the Tx Clock button is run (24 hour clock).
End Time	If the treatment is still underway, this is the projected time for the end of treatment, based on the current time and RTD. Otherwise it is the clock time when the treatment actually ended, based on the Tx clock (24 hour clock).
Actual Tx time	This is the total treatment time, even if the treatment continued after RTD counted down to zero (minutes).
RTD	The current Remaining Time of Dialysis (minutes).
Begin BP	Displays the first Diastolic, Systolic (mmHg) and pulse reading (beats/min). If any of the readings is out of the alarm range, the entire line is shown in red.
End BP	Displays the last Diastolic, Systolic and pulse reading. If any of the readings is out of the alarm range, the entire line is shown in red.
Diastolic Range	Displays the highest and lowest Diastolic pressure reading during the treatment. If any of the readings is out of the alarm range, the entire line is shown in red.
Systolic Range	Displays the highest and lowest Systolic pressure reading during the treatment. If any of the readings is out of the alarm range, the entire line is shown in red.
MAP Range	Displays the highest and lowest Mean Arterial Pressure (MAP) during the treatment. If any of the readings is out of the alarm range, the entire line is shown in red (mmHg).
Pulse Range	Displays the highest and lowest pulse rate during the treatment. If any of the readings is out of the alarm range, it is shown in red.
UF Goal	This is the UF goal selected for the treatment (ml).
UF Removed	This is the UF removed at this point in the treatment (ml).
Avg UF Rate	This is the average UF rate at this point in the treatment (ml).
UF Time	This is the UF time selected for the treatment (min).
UF Profile	This is the UF profile # selected for the treatment

Display	Description
Final RBV	This is the last Relative Blood Volume from the BVM, if available (% of initial value)
Concentrate	This is the concentrate selected for this treatment
SVS profile	This is the Sodium Variation System profile selected for the treatment
Na Base	This is the base Na level for the Sodium Variation System program (mEq/l)
Na Start	This is the starting Na level for the Sodium Variation System program (mEq/l). If SVS is not selected, it is the sodium used.
SpKt/V	This is the current Single pool Kt/V (SpKt/V). If the projected Kt/V is below the acceptable level, the value is shown in red.
eKt/V	This is the current equilibrated Kt/V (eKt/V)
Volume	This is the volume used for the Kt/V calculation (liters)
BVP	This is total blood volume processed (liters).
Kt	This is effective blood volume processed (liters).
Avg Art Press	This is the average arterial pressure for the treatment (mmHg)
Mean Kecn	The time weighted average of the individual Kecn measurements
Avg Ven Press	This is the average venous pressure for the treatment (mmHg)
Avg Dial. Flow	This is the average dialysate flow used for the treatment (ml/min)
Avg blood Flow	This is the average blood flow used for the treatment (ml/min)
Last Access Flow	This is the last access flow determination, if available (ml/min)
Avg Recirc.	This is the average of all the recirculation determinations made for this treatment (%)
Low Volume	This shows whether or not the Low Volume option is set.
High Flux	This shows whether or not the High Flux dialyzer option is set.

Kt/V & Access Flow Monitoring

How Kt/V is Derived

Online Clearance (OLC)—used in estimating the effectiveness of the dialysis treatment—can be viewed in the “Kt/V AF” screen. The effectiveness of the treatment is based on the amount of urea that is removed from the patient’s blood. It has been shown that sodium can be used as a surrogate to urea for determining removal rates (clearance). The key to determining the amount of urea cleared is based on the fact that urea clearance is almost identical to sodium clearance.

To measure the effectiveness of treatment, the concentration of sodium in the dialysate is adjusted for a brief duration. This changes the conductivity of the dialysate. The conductivity of the dialysate is then measured before and after it passes through the dialyzer. As the dialysate passes through the dialyzer, some of the sodium diffuses through the membrane resulting in a different, post-dialyzer, conductivity reading. The amount of sodium clearance (K_{ecn}) can be calculated based on the change in conductivity of the dialysate after it passed through the dialyzer.

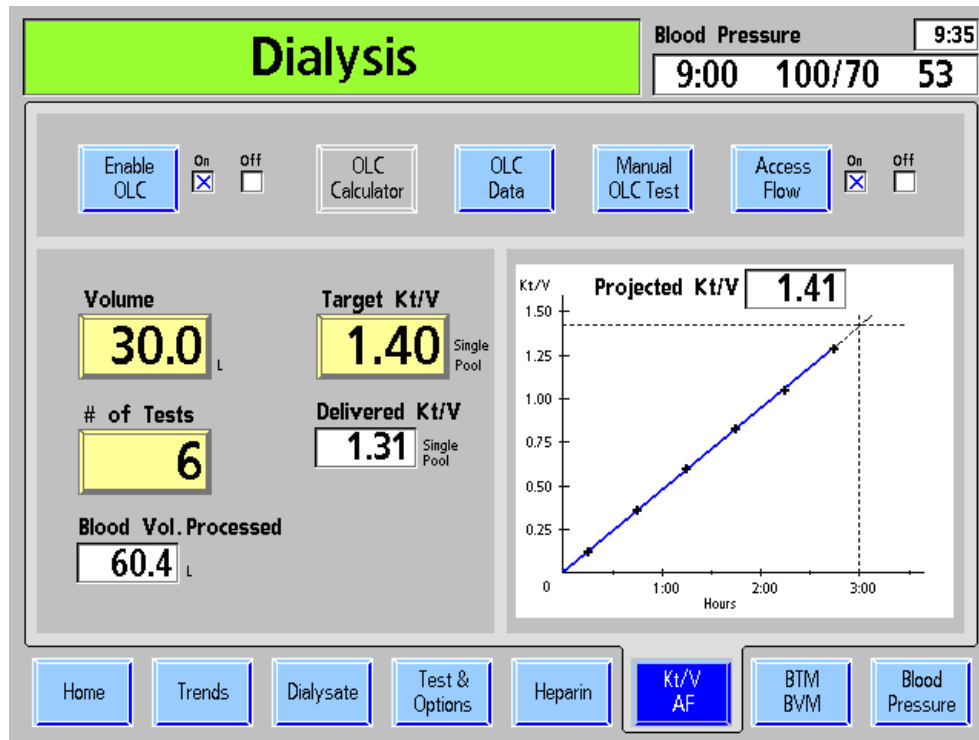

Figure 47 – The Kt/V and Access Flow Screen



The following table describes the features found in the “Kt/V AF” screen on machines with active OLC functionality.



Note: If the OLC functionality has been deactivated (in the Service Mode) on your machine, all features will be inactive and appear grayed out.

Table 26 – The “Kt/V AF” Screen Buttons and displays

Button	Function
	This button activates and deactivates the OLC option as indicated by the check box to the right. By default, OLC is enabled.
	This button brings up the OLC Calculator—a useful tool for estimating the treatment effectiveness and time required based on various treatment parameters. (Not available at this time).
	Selecting the OLC Data button opens the “OLC” subscreen that provides the actual results of each OLC test.
 	<p>This button changes functions based on the machine status.</p> <p>When there is no blood sensed and the blood pump is stopped or the dialysate lines are on the shunt, selecting this button followed by the CONFIRM key initiates the OLC Self Test.</p> <p>When blood is sensed, an unscheduled clearance test is initiated. The manual test takes the place of one of the scheduled tests entered in the # of Tests button.</p>
	<p>This button is used to allow the Access Flow test to be performed. When it is turned On (by selecting it, pressing the CONFIRM key, pressing the round left arrow key on the Navigation Keypad and CONFIRM again), the machine will offer to do the Access Flow test following the next OLC test. If it is inconvenient to do the test early in the treatment, this button may be left in the Off position and turned On when it is convenient. Select the Manual OLC Test button and press CONFIRM after turning on the Access Flow to begin the process right away. When the test is initiated, the operator is guided through the steps necessary to perform the test.</p>
	<p>Warning! To avoid the possibility of significant blood loss, be sure that the connections are well secured after disconnecting and reconnecting the bloodlines.</p>
	The patient’s urea-distribution volume (in liters) is entered here. This value should be determined using urea-kinetic values. Anthropometric formulae may give different results than kinetically calculated urea-distribution volume.
	The prescribed target single-pool value, ranging from 0.40 to 2.50, is entered in this button. This value is reset to the default value when the New TX key is pressed. The default value may be changed in Service Mode.

Button	Function
# of Tests 	The # of Tests button is used to access the number of tests that will be run automatically during dialysis. From one to six tests can be chosen per treatment (six is the default setting). The first and last tests are conducted 15 minutes after the beginning of dialysis and 15 minutes before the end of dialysis. The remaining tests are performed at equally spaced intervals between the first and last tests, unless manual tests are run.
Blood Vol Processed 	This value indicates the total blood volume (in liters) that has passed through the dialyzer based on the blood pump flow rate.
Projected Kt/V	This is the expected Kt/V when RTD is at zero, based on the delivered Kt/V and the Kecn values.
Delivered Kt/V	This is the delivered Kt/V at this point in the treatment.

Reading Kt/V

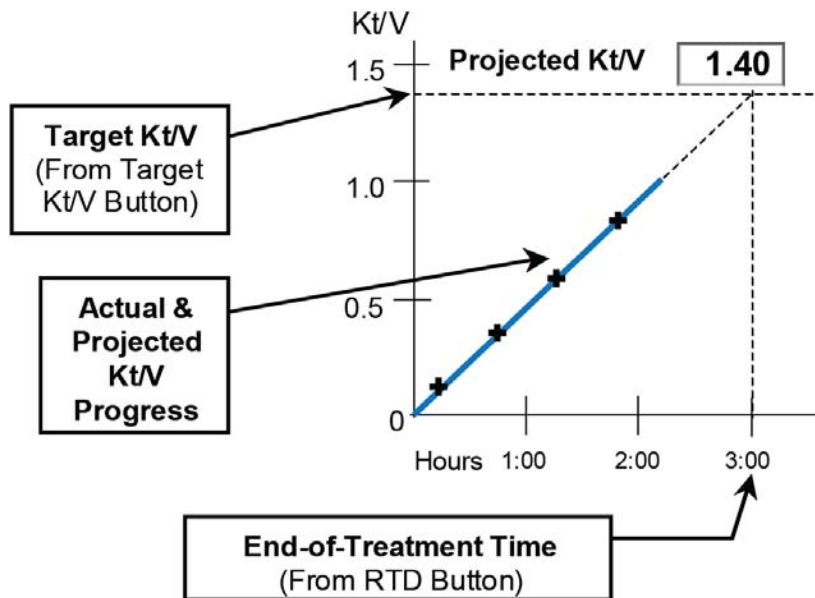

Figure 48 – Kt/V Graph

The Kt/V graph is located on the right side of the “Kt/V AF” screen (See Figure 47). The vertical axis on the left side of the graph represents target Kt/V values. The horizontal axis along the bottom of the graph represents treatment time in hours.

The horizontal, dashed line near the top of the graph represents the value displayed in the **Target Kt/V** button. The vertical, dashed line located on the right side of the graph represents the prescribed length of the treatment (i.e., the value displayed in the **RTD** button of the “Home” screen at the start of treatment). The point where these lines cross represents the target Kt/V at the end of the prescribed treatment.

After the first OLC test, a line appears in the Kt/V graph that plots both the current and anticipated effectiveness of the treatment. The solid blue or red line represents the current amount of delivered therapy (Kt/V) from the beginning of treatment up to the time of the last test. The gray dotted portion indicates the projected effectiveness of the treatment assuming the clearance rate remains steady at its present rate. If the effectiveness of the treatment is projected to reach at least 100% of the minimum Kt/V or 85% (depending on selected Service Mode option) of the target Kt/V at the end of treatment, the solid portion of the curve will appear blue. If the projected effectiveness is less than 100% of the target Kt/V, the solid portion of the curve will appear red and an exclamation mark icon is displayed to the right of the graph.

Using Figure 47 as an example, the graph indicates the following data:

- The last test was taken about two hours and 45 minutes after the beginning of a three-hour treatment.
- The target Kt/V is 1.40
- The Kt/V at the current time (Delivered Kt/V) is 1.31
- The projected Kt/V at the end of the treatment is 1.41
- Since the Projected Kt/V of the treatment is 100 percent of the target Kt/V (1.40) by the end of treatment, the line is blue.

If after an OLC test, the projected effectiveness for the end of the treatment is less than 100 percent of the target Kt/V, the solid portion of the plot appears red and an exclamation mark icon is displayed to the right of the graph (see Figure 49 below).

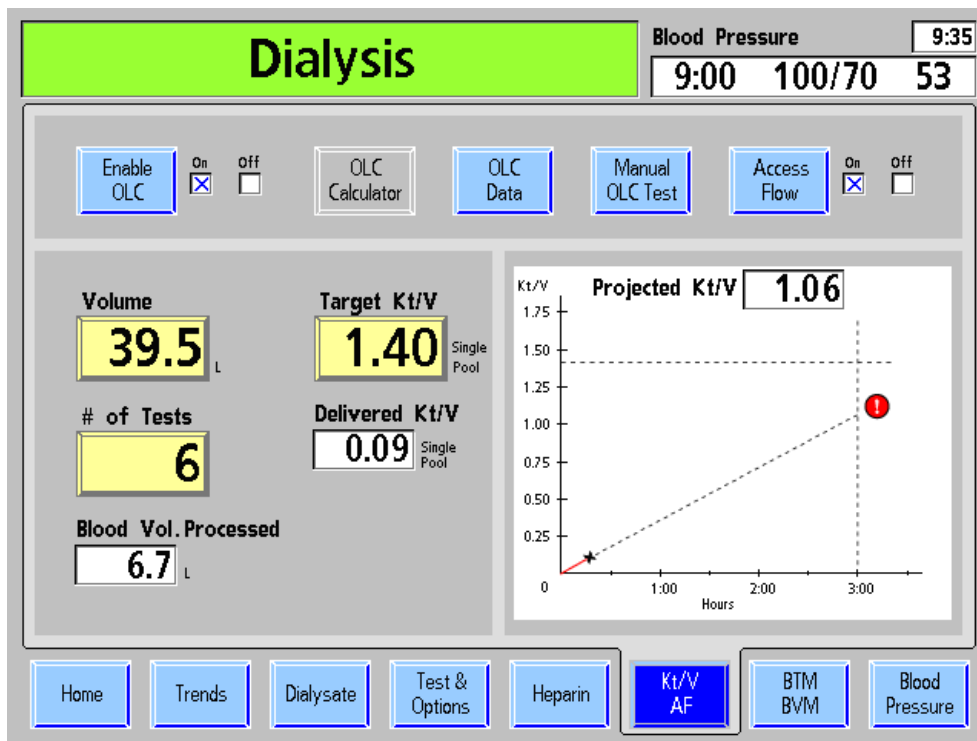

Figure 49 – Projected Clearance is less than 100 Percent of Target

In cases of unsatisfactory Kt/V, the operator should check:

- For proper needle placement and connections to the bloodlines.
- That the machine is set for prescribed blood flow rate.
- That the proper dialyzer is being used.
- That the dialysate flow rate is as prescribed.
- That the blood and dialysate lines are properly connected to the dialyzer so that the blood and dialysate flow are countercurrent (blood flow down, dialysate flow up).
- If the preceding is correct, check the patient's access flow rate (fistula or graft).

A substandard Kt/V could also indicate a problem with clotting, recirculation within the patient's access, or other problems.

While a treatment is in progress, the Kt/V may be increased by increasing the flow rate of the blood pump or increasing the dialysate flow rate. Changes to the prescribed treatment parameters, however, should be consistent with a physician's orders.



Note: The OLC self test should be run occasionally (1 – 2 times per month) or any time that you suspect that the OLC results may be erroneous

Access Flow

How Access Flow is Derived

In order to determine the patient's access flow rate (AF), two OLC tests are done, one with the bloodlines connected in the normal position and one in the reversed position. In the reversed position, recirculation is induced. The higher the patient's access flow rate, the lower the recirculation. With the two OLC tests, the access flow rate can be calculated. The measurement is more accurate at lower access flow rates. Because it may be difficult to obtain high blood flow rates with the bloodlines in the reversed position, it may be necessary to reduce the blood flow rate for both tests. The result will be more accurate if both tests are done at the same blood flow rate.



Note: Fresenius Medical Care recommends using *Combiset bloodlines with Twister blood flow reversal device* (P/N 03-2794-0) for treatments running access flow tests. The integrated Twister device eliminates the need to disconnect the bloodlines from the access during treatment. All blood flow direction changes are done aseptically within the Twister device.

How to run the Access Flow test

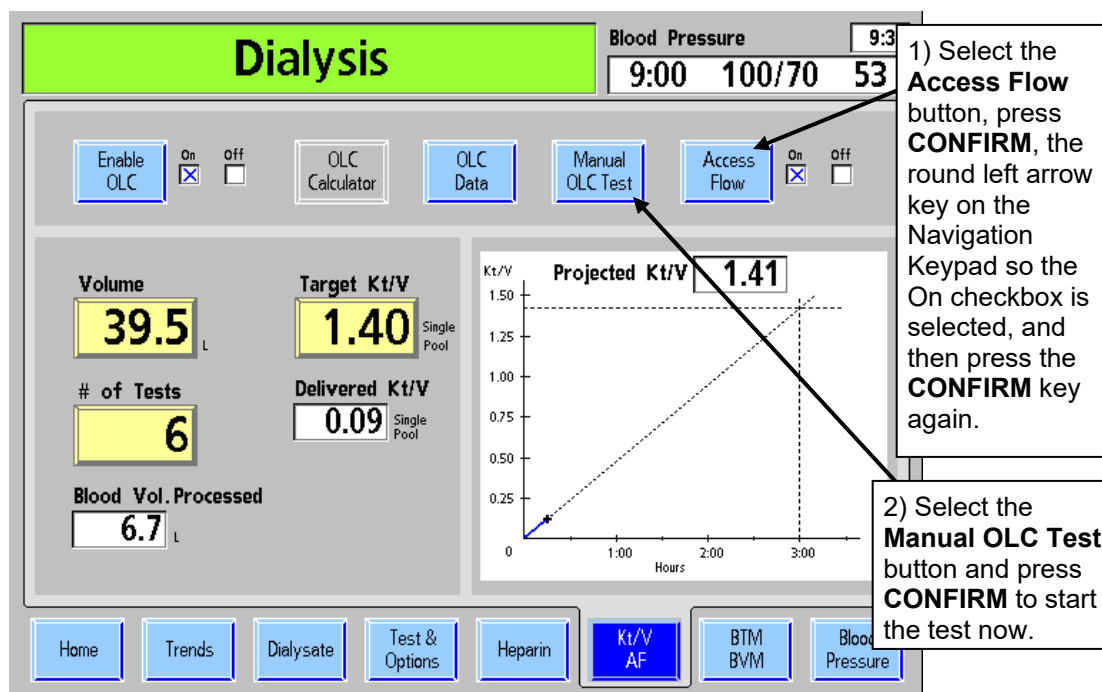

Figure 50 – Starting an Access Flow Test

When the **Access Flow** button is turned ON, the machine will offer to do the Access Flow test following the next OLC test. The **Access Flow** button may be left in the Off position and turned On later. If desired, select the **Manual OLC Test** and press **CONFIRM** after turning the Access Flow ON to begin the test right away. If you display the “Kt/V AF” screen while doing the test, more detailed instructions are displayed.



Warning! The Access Flow procedure requires that the bloodline connections to the access needles be reversed and later returned to their original position. To avoid the possibility of significant blood loss, be sure that the connections are well secured after disconnecting and reconnecting the bloodlines.

Warning! Use aseptic technique when doing this procedure.

Warning! Return the bloodlines to the original position (red to red and blue to blue) when the test is completed. Failure to do so will result in lower delivered therapy.



Note: If the access flow rate is less than or equal to the blood pump rate, the access flow rate will be calculated and reported as approximately the blood pump rate. In this case, the access flow rate may be lower than indicated.

Note: During the second OLC measurement for the Access Flow test, the UF will change to 70 if running low flux or 300 if running high flux.

OLC Data Screen

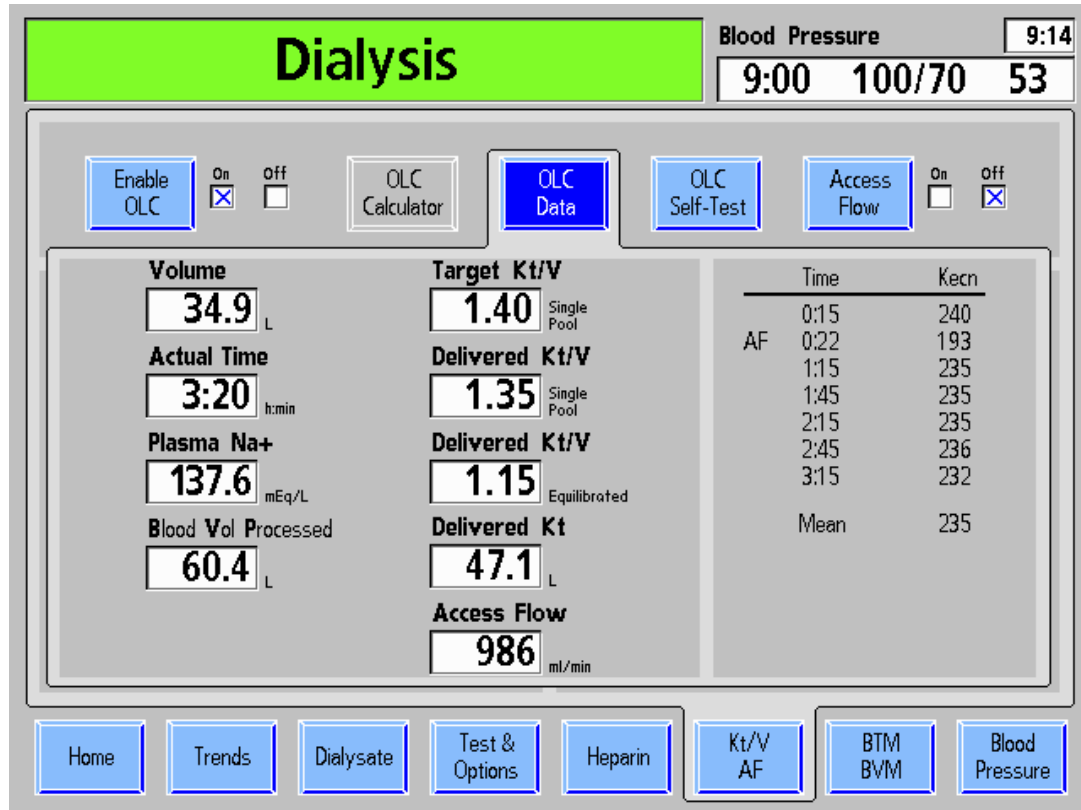

MONITORING TREATMENT

Figure 51 – OLC Data Screen

The OLC Data screen provides the actual clearance data of the treatment

Table 27 – The OLC Data Screen Features

Feature	Function
Volume <div style="border: 1px solid black; padding: 2px; display: inline-block;">34.9 L</div>	The calculated, urea-distribution, fluid volume of the patient. This is the same volume entered in the “Kt/V AF” screen.
Actual Time <div style="border: 1px solid black; padding: 2px; display: inline-block;">3:20 h:min</div>	This data box displays in hours and minutes the amount of time the patient has been on dialysis.
Plasma Na+ <div style="border: 1px solid black; padding: 2px; display: inline-block;">137.6 mEq/L</div>	This data box displays the OLC-calculated value for plasma sodium after the first OLC test.
Blood Vol Processed <div style="border: 1px solid black; padding: 2px; display: inline-block;">60.4 L</div>	This value indicates the total blood volume (in liters) that has passed through the dialyzer based on the blood pump flow rate and adjusted for negative arterial pressure.

Feature	Function																				
Target Kt/V <div style="border: 1px solid black; padding: 2px; display: inline-block;"> 1.40 </div> Single Pool	The value displayed here is the same value entered in the Target Kt/V button in the “Kt/V AF” screen.																				
Delivered Kt/V <div style="border: 1px solid black; padding: 2px; display: inline-block;"> 1.35 </div> Single Pool	This data box displays the current calculated amount of single pool Kt/V delivered therapy.																				
Delivered Kt/V <div style="border: 1px solid black; padding: 2px; display: inline-block;"> 1.15 </div> Equilibrated	This data box displays the calculated equilibrated Kt/V. It is calculated one hour after the beginning of treatment. The box remains blank until then.																				
Delivered Kt <div style="border: 1px solid black; padding: 2px; display: inline-block;"> 47.1 </div> L	This data box displays the value for the equation (time weighted mean Kecn) x (current time).																				
Access Flow <div style="border: 1px solid black; padding: 2px; display: inline-block;"> 986 </div> ml/min	This is the result of the Access Flow test. It is limited to <2000 ml/min.																				
<table border="1" style="width: 100%; border-collapse: collapse;"> <thead> <tr> <th style="width: 30%;">Time</th> <th style="width: 30%;">Kecn</th> </tr> </thead> <tbody> <tr> <td></td> <td></td> </tr> <tr> <td>AF 0:15</td> <td>240</td> </tr> <tr> <td>0:22</td> <td>193</td> </tr> <tr> <td>1:15</td> <td>235</td> </tr> <tr> <td>1:45</td> <td>235</td> </tr> <tr> <td>2:15</td> <td>235</td> </tr> <tr> <td>2:45</td> <td>236</td> </tr> <tr> <td>3:15</td> <td>232</td> </tr> <tr> <td>Mean</td> <td>235</td> </tr> </tbody> </table>	Time	Kecn			AF 0:15	240	0:22	193	1:15	235	1:45	235	2:15	235	2:45	236	3:15	232	Mean	235	<p>Data Table—This table displays the individual and mean Kecn data for the OLC and Access Flow tests. Time refers to when the tests was performed in respect to amount of time (hours:min) elapsed from the beginning of treatment.</p> <p>Manual tests are preceded with “M”.</p> <p>Tests done for Access flow with the lines reversed are preceded with “AF”. These tests are not used in the Mean Kecn value.</p>
Time	Kecn																				
AF 0:15	240																				
0:22	193																				
1:15	235																				
1:45	235																				
2:15	235																				
2:45	236																				
3:15	232																				
Mean	235																				

Blood Temperature Monitor/ Blood Volume Monitor Screen

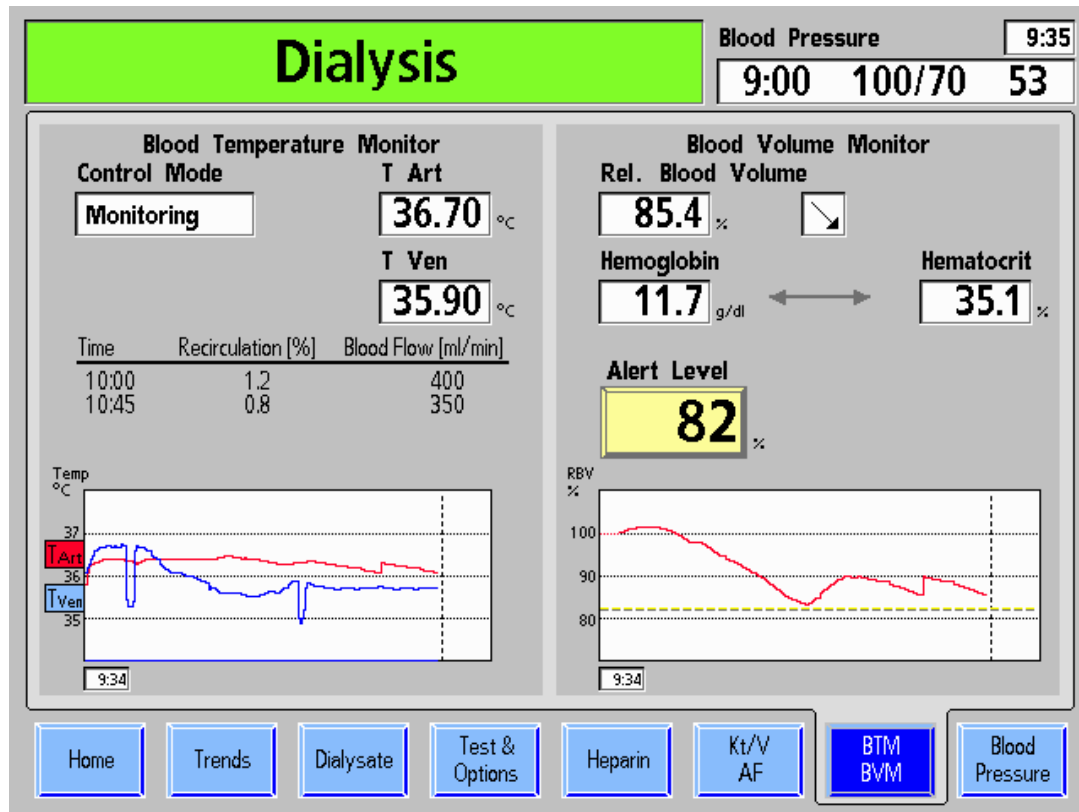

MONITORING
TREATMENT

Figure 52 – BTM and BVM Monitoring Screen

The Blood Temperature Module (BTM) is an optional and separate device with its own Operator's Manual. For a complete understanding of the functions of the BTM, please refer to P/N 470164. The BTM functions utilize the keys on the module itself for operation. The display screen is used only for displaying the results and operations of the BTM; none of the parameters are entered outside the BTM module.

The Blood Volume Module (BVM) is an optional and separate device with its own Operator's Manual. For a complete understanding of the functions of the BVM, please refer to P/N 490041. The BVM functions utilize the keys on the module itself for operation. In addition, the display screen is used to display a graphical representation of the blood volume over time and to select the alert level where an alarm will occur.

BTM function

The BTM has two primary functions – to regulate the patient's temperature (energy) and to use temporary changes in dialysate temperature to determine the extent of recirculation at the blood access site.

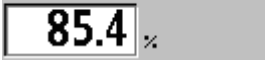

Table 28 – The BTM Data Screen Features

Feature	Function									
<p>Control Mode</p> <p>Recirculation</p>	<p>This area will display “Recirculation” when a recirculation test is being done. When there is no control program, it will read “Monitoring.” It will read “Temperature” or “Energy” when in a temperature or energy control mode.</p>									
<p>T Set</p> <p>37.1 °C</p>	<p>When performing a recirculation measure, the data box will display the T set value that the dialysate will reach.</p> <p>When in a temperature control mode, this area will display the rate of temperature change prescribed to warm or cool the patient in °C/h.</p>									
<p>Energy Rate</p> <p>-11.7 °C</p>	<p>When in an energy control mode, this display will indicate the energy flux to or from the patient in kilojoules per hour (kJ/h).</p>									
<p>T Art</p> <p>36.70 °C</p>	<p>This displays the arterial bloodline temperature as reported by the BTM module</p>									
<p>T Ven</p> <p>35.90 °C</p>	<p>This displays the venous bloodline temperature as reported by the BTM module.</p>									
<table border="1"> <thead> <tr> <th>Time</th> <th>Recirculation [%]</th> <th>Blood Flow [ml/min]</th> </tr> </thead> <tbody> <tr> <td>10:00</td> <td>1.2</td> <td>400</td> </tr> <tr> <td>10:45</td> <td>0.8</td> <td>350</td> </tr> </tbody> </table> 	Time	Recirculation [%]	Blood Flow [ml/min]	10:00	1.2	400	10:45	0.8	350	<p>The table above the graph will display up to 3 recirculation values. This graph shows the arterial temperature in red and the venous temperature in blue. During recirculation tests the temperature will show changes for a short period of time. The vertical dotted line indicates the scheduled end of treatment.</p>
Time	Recirculation [%]	Blood Flow [ml/min]								
10:00	1.2	400								
10:45	0.8	350								



Note: When the 2008K² hemodialysis machine is first turned on, the small display on the BTM will indicate 1107. This is a normal event and can be cleared by pressing the Up Δ (Error) and Down ▽ (Result) keys on the BTM module at the same time.

Table 29 – The BVM Screen Features

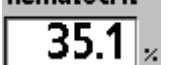
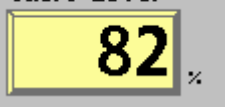
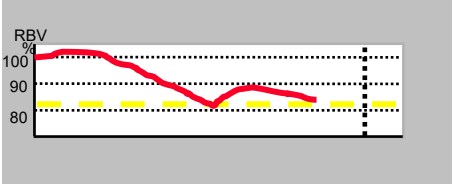
Feature	Function
<p>Rel. Blood Volume</p> 	<p>The Relative Blood Volume (RBV) is the relation of the current blood volume and the blood volume on the start of dialysis expressed in %. Thus, RBV is always 100% in the beginning. If at the end of the dialysis, RBV is e.g. 80%, the blood volume has been reduced by 20%. There can also be values of above 100%.</p>
	<p>The Trend Indicator is an arrow, which roughly shows the current direction and intensity of blood volume change. On the display the arrow is shown to the right of the measured value for RBV. The arrow symbols have the following meanings:</p> <ul style="list-style-type: none"> ↑: significant increase ↗: moderate increase →: nearly constant ↘: moderate decrease ↓: significant decrease
<p>Hemoglobin</p>  <p>Hematocrit</p> 	<p>The red blood cells (erythrocytes) are responsible for the transport of gases in the blood (oxygen and carbon dioxide). Hemoglobin, an iron compound giving the erythrocytes their red color, is the active component in this process.</p> <p>The hematocrit (HCT) is the packed cell volume (almost exclusively of erythrocytes) in the blood volume.</p>
<p>Alert Level</p> 	<p>This button allows to set a patient individual Alert Level for RBV. The range is 70% to 100%. Entering zero deactivates the alert function.</p> <p>If RBV reaches the Alert Level, the machine will give an audible warning and will stop ultrafiltration. Press RESET to turn the Ultrafiltration pump back on. This alarm occurs only once if the user does not set another Alert Level.</p>
	<p>This graph shows the Relative Blood Volume in red. During time periods when the BVM can't determine RBV (e.g. saline flush) the red line will continue dotted with the last transferred value. The yellow dotted line shows the alert level. The vertical dotted line indicates the scheduled end of treatment.</p>

MONITORING TREATMENT

Blood Pressure Screen Monitoring

The following are generally accepted contraindications for using a timed automatic blood pressure instrument utilizing the oscillometric principle:

- Use of a heart lung machine
- Peripheral circulation problems
- Severe arrhythmia
- Ectopic beats
- Convulsions
- Spasms
- Tremors
- Tachycardia

This is a guideline only. Final determination of the suitability of any medical instrument for use with any patient is the responsibility of the treating physician.

The results of tests performed with the Blood Pressure module are recorded on the left side of the “Blood Pressure” screen (see Figure 53).

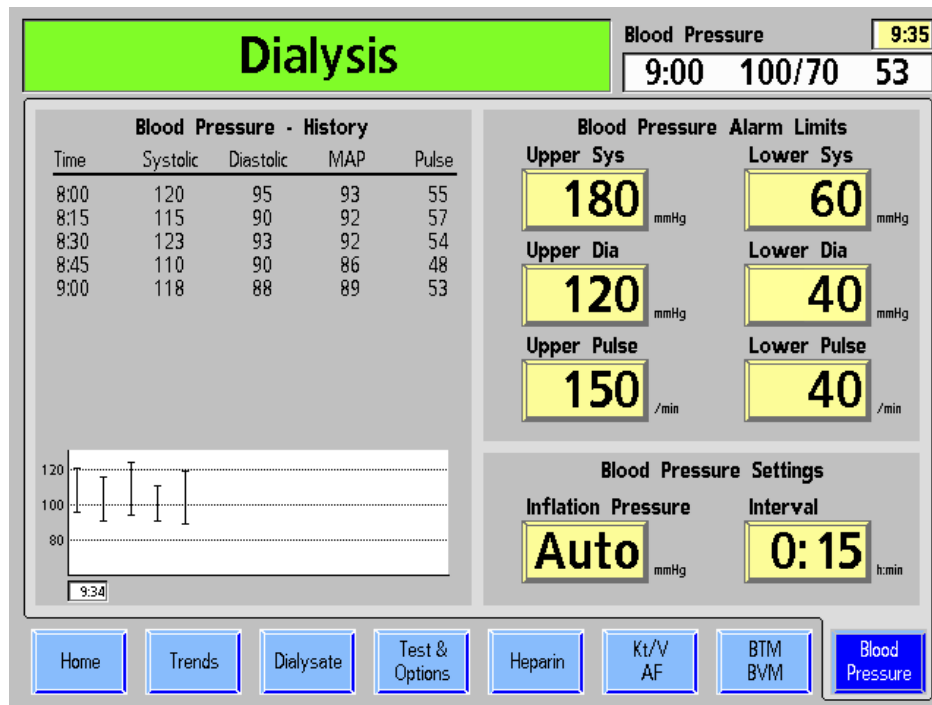
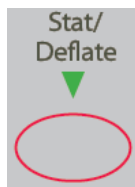

Figure 53 – Blood Pressure Screen

The blood pressure readings are displayed both in table and graph form (the graph can also be viewed in the “Trends” screen). The table lists the time the blood pressure reading was taken, the systolic and diastolic pressures, the Mean Arterial Pressure (MAP), and the pulse rate of the patient during the test. The MAP is measured by the blood pressure module and thus may differ from MAP calculated from systolic and diastolic pressure.

The pressure readings on the graph are represented by vertical lines with ticks at the top and bottom signifying the systolic and diastolic pressures respectively. The first pressure reading is displayed on the left side of the graph with subsequent readings appearing to the right. The table on screen displays a maximum of 10 pressure readings at a time.



The **Stat/Deflate** key, located on the right side of the control panel, can be used to quickly relieve the pressure from an inflated blood pressure cuff. It will also start an unscheduled blood pressure reading if the cuff is deflated. Unscheduled tests do not have any effect on the scheduled tests. For example, if the tests were scheduled at 15-minute intervals, and a manual test was taken five minutes after the first test, the next test will still occur 15 minutes after the first one. The results of both automatic and manual tests are displayed in the table. Results appear in the graph only after the Tx Clock is started.



Note: For accurate blood pressure readings, the cuff must be the proper size and positioned at heart level. Each centimeter above or below the heart that the cuff is positioned, will result in a reading error of ± 0.8 mmHg. Tests taken with the Tx Clock paused do not show up on graph.

During Treatment

Online Pressure Holding Test

The online Pressure Holding Test (PHT) automatically checks the integrity of the dialysate balancing system during dialysis when the dialyzer is connected. The online PHT detects most leaks in the hydraulics that would affect the precise volumetric control of fluid in the dialysate system.

The online PHT complements the self-test sequence; it is not a substitute. It is still necessary to perform the initial Automatic Test Sequence before each high flux treatment.

The online PHT runs every 12 minutes regardless of the other alarm conditions. Dialysate flow must be on and the machine cannot be executing a filling program or OLC test. The test runs for two balancing-chamber cycles (about seven seconds). The message “RUNNING ONLINE PHT” displays during the test. Before the test, the UF pump stops in the middle of a cycle and remains off during the two balancing chamber cycles of the online PHT. The UF green light will flash during this time. The machine is in bypass mode during the test period. The displayed TMP during this time represents pressure within the hydraulics, therefore, the TMP reading may change slightly. The TMP alarm limits are spread during the test.

Online PHT Failure

If the machine fails the online PHT, the message “ONLINE PHT FAILED” is displayed in the Status Box. The blood pump does not stop during this alarm condition. This alarm can be cleared by pressing the **RESET** button.

Online PHT failures can be caused by problems that make it difficult to control the patient’s fluid balance. Some failure alarms can be caused by air entering the hydraulic system from faulty concentrate or dialyzer line connections. The operator should inspect the machine for external air intake and fluid leaks, and make the appropriate corrections if possible.

Discontinue the treatment and take the machine out of service if an online PHT failure alarm recurs. The hydraulics should be inspected by a qualified technician before returning the machine to service.

If an online PHT failure occurs once during a treatment, perform the Pressure Holding Test (from the “Test & Options” screen) before the next treatment to verify the integrity of the hydraulic system.

Blood Recirculation Procedure

It is the responsibility of the unit’s medical director to determine the appropriate anti-coagulation protocol and the maximum length of time for recirculating blood.

1. Return blood if possible.

To recirculate blood within the extracorporeal blood circuit:

2. Select the **Tx Clock** button and press **CONFIRM** (to ‘paused’).
3. Press the blood pump **Start/Stop** key to stop the blood pump.
4. Disconnect the arterial and venous bloodlines from access in an aseptic manner, and connect them together with a sterile recirculation connector.



Note: Infuse heparin per facility protocol.

5. Unclamp saline bag.
6. Press the **Start/Stop** key to start the blood pump, and set the blood flow rate at 150–200 ml/min. An audible alarm will sound every five minutes to alert the operator that the Tx Clock is paused with blood sensed.
7. Press the **RESET** key to clear the alarm.

To reconnect the patient to machine:

1. Press the **Start/Stop** key to stop the blood pump

2. Clamp the saline line.
3. Aseptically reconnect the arterial and venous bloodlines to the patient's access sites.
4. Restart the blood pump and adjust blood pump to the prescribed flow rate.
5. Select the **Tx Clock** button and press **CONFIRM** to resume the treatment.

Power Failure during Dialysis

In case of a power failure, the blood pump stops and the venous line clamp closes. The dialysate flow pump, heater, blood leak detector, and level detector are non-functional. All function lights go out. A steady, audible alarm will immediately sound for seven minutes that cannot be silenced with the **Mute** key. It can be silenced manually, however, by removing the 9-volt battery from the back of the machine.

Manually Operating the Blood Pump

In the event of a power failure during treatment, the 2008K² blood pump can be manually operated to return the blood to the patient or to keep the blood in recirculation if a quick resumption of power is anticipated. Either option is accomplished with the auxiliary hand crank supplied with the machine (see Figure 54). The hand crank is attached to the back of the machine.

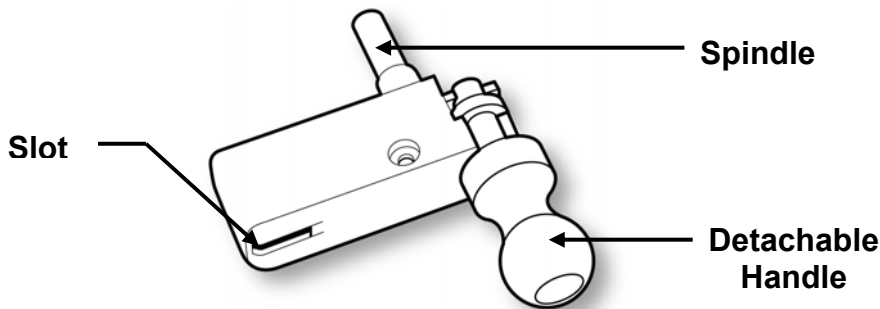

Figure 54 – Auxiliary Blood Pump Crank



Note: As a precaution, the handle will detach from the crank when attempting to turn the rotor in the wrong direction. An arrow embossed on the face of the pump-segment housing points in the correct direction of rotation (clockwise).

Returning the Blood to the Patient Manually

To return the blood manually:

1. Remove the bloodline from venous line clamp. If you are performing single-needle dialysis, remove the pump segment from the single-needle pump.
2. Replace saline bag with a fresh bag if necessary.
3. Using a hemostat, clamp the arterial bloodline directly above the saline “T”.
4. Open the saline line clamps and rinse the blood in the tubing below the saline “T” back to the patient. When the blood in the line has been rinsed back to the patient, close the saline line clamps.
5. Clamp the arterial bloodline directly under the saline “T”. Remove the clamp on the bloodline above the saline “T” and open the saline line clamps.
6. Open the pump door and flip the rotor latch outward (see Figure 55 #1).

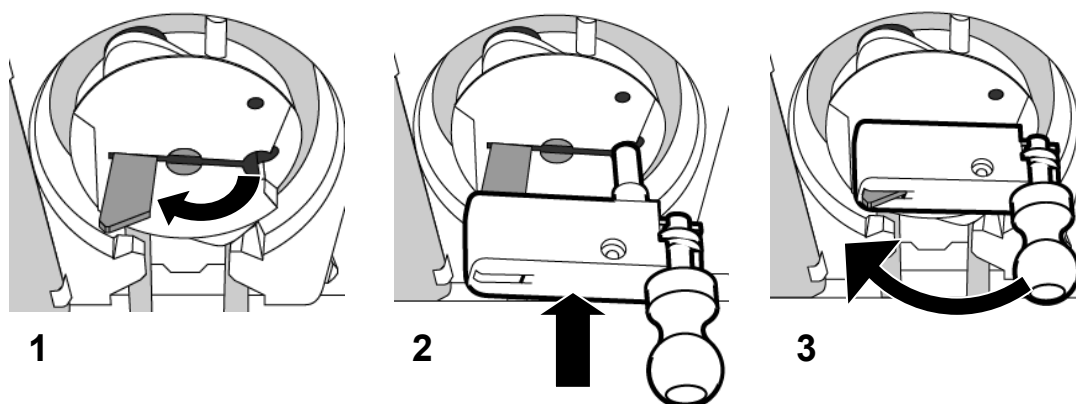

Figure 55 – Inserting the Blood Pump Crank

7. Align the slot and the spindle on the crank handle with the rotor latch and hole as shown in Figure 55 #2 above.
8. Slide the crank handle in as far as it will go. The crank latch will protrude slightly from the crank handle (see Figure 55 #3).
9. Rotate the crank clockwise and rinse back the blood with the saline according to unit protocol. The blood should be returned under strict visual control.



Warning! Carefully observe the venous chamber and bloodline for the presence of air. Be sure no air will be infused into the patient.

10. Clamp the arterial and venous bloodlines and the patient’s arterial and venous access lines, and aseptically disconnect them.

Manual Circulation

To circulate the blood manually:

1. Remove venous line from clamp. Be sure no air will be infused into the bloodline. If you are performing single-needle dialysis, remove the pump segment from the single-needle pump.

2. Open the pump door and flip the rotor latch outward (see Figure 55 #1).
3. Align the slot and the spindle on the crank handle with the rotor latch and hole as shown in Figure 55 #2 above.
4. Slide the crank handle in as far as it will go. The crank latch will protrude slightly from the crank handle (see Figure 55 #3).
5. Rotate the crank clockwise at a rate of 6–10 rotations per minute. This is equivalent to a blood flow rate of 60–100 ml/min. Observe the venous chamber and bloodline to ensure that no air is infused in the patient. Manual circulation time is the responsibility of the clinic’s medical supervisor.



Warning! Carefully observe the venous chamber and bloodline for the presence of air. Be sure no air will be infused into the patient.

Power Resumption Procedure

1. Press the **POWER** key to restore power to the machine. The screen displays the “Select Program” screen with the message, “POWER FAIL RECOVERY.”
2. Select the **Dialysis** button and press **CONFIRM** to enter the “Dialysate” screen.
3. In the “Dialysate” screen, check the conductivity settings (Na⁺, Bicarbonate, concentrate type) and alarm limits. Verify that the dialysate concentration settings are correct. If not, reset them.
4. Press **CONFIRM** to save the dialysate settings.
5. Press the **Home** screen-key to display the “Home” screen.
6. Press the **RESET** key to reset any alarms. Conductivity and temperature alarms will reset automatically when acceptable limits are reached—usually in about 3–5 minutes. If the dialysate lines were disconnected, reconnect the dialysate lines when conductivity and temperature return to their prescribed limits.
7. Insert venous line in venous clamp and optical detector.
8. If not still connected, reconnect the patient per unit policy. If you are performing single-needle dialysis, re-insert the pump segment into the single-needle pump.
9. Press the blood pump **Start/Stop** key to restart the blood pump. Reset the blood pump to the prescribed flow rate.
10. Select the **Tx Clock** button to resume dialysis and then press **CONFIRM**.
11. If the heparin pump or the Single-Needle option were active prior to the power failure, reinitiate these functions upon power resumption.
12. The SVS program parameters are stored during a power failure. Restart the SVS Profile program by pressing the **SVS on/off** key. Adjust the SVS-Time if necessary.
13. The UF treatment parameters are also saved during a power failure. Check all parameters (UF Goal, UF Time, UF Rate, UF-Removed) for correct settings and adjust if necessary.

Completion of Dialysis

At the end of treatment, when the RTD timer has counted down to 0:00, an alarm sounds and the message, RTD = ZERO, appears in the Status box. An alarm also sounds when the set amount of ultrafiltrate has been removed. When that happens, the Status Box displays the message, UF GOAL REACHED. To reset either alarm, press the **RESET** key. If the UF GOAL REACHED and RTD = ZERO alarms occur simultaneously, pressing the **RESET** key will reset both alarms.

Returning Blood to the Patient

To return the blood to the patient:

1. Select the **Tx Clock** and then press **CONFIRM** to stop the treatment.
2. Press the **Start/Stop** key on the blood pump to stop the pump.
3. Replace saline bag with a fresh bag if necessary.
4. Rinse the blood in the patient end of the arterial bloodline back to the patient:
 - a. Using a hemostat, clamp the arterial bloodline directly above the saline “T”.
 - b. Open the saline line clamps and rinse the blood in the tubing below the saline “T” back to the patient. When the blood in the line has been rinsed back to the patient, close the saline line clamps.
5. Rinse the remaining blood in the bloodline back to the patient:
 - a. Clamp the arterial bloodline directly under the saline “T”.
 - b. Remove the clamp on the bloodline above the saline “T” and open the saline line clamps.
 - c. Start the blood pump and set a rate of 150-200 ml/min.
 - d. When the blood has been returned to the patient, turn the blood pump off and close the saline line clamps.



Warning! Check all bloodlines and dialysate lines for leaks. Keep access sites uncovered and monitored. Improper bloodline connections or needle dislodgements can result in excessive blood loss, serious injury, and death. Machine alarms may not occur in every blood loss situation

6. Clamp the arterial and venous bloodlines and the patient’s arterial and venous access lines, and aseptically disconnect them.



Note: Depending on how your machine was configured, an audible alarm may sound when the saline solution reaches the optical sensor. Press **RESET** to silence the alarm.

Removing the Dialyzer

There are two procedures for removing the dialyzer depending on whether your facility reuses dialyzers. Follow the appropriate procedure for your situation.

If Reuse is practiced

The dialysate compartment should not be emptied prior to cleaning the dialyzer. In such cases:

1. Open the shunt door and place the dialyzer connectors on the shunt. Close the shunt door.
2. Cap the dialyzer ports with the caps supplied with the dialyzer and process dialyzer as per unit protocol
3. Discard the bloodlines and transducer protectors according to facility policy
4. Clean or disinfect machine according to routine cleaning and maintenance procedures described in “Disinfection and Maintenance,” on page 125.

If Reuse is not practiced

To remove the fluid in the dialysate compartment:

1. Open shunt interlock door
2. Return blue dialyzer connector to shunt interlock
3. Reposition the dialyzer so that the red, outlet port is at the bottom
4. Close the shunt interlock door. Message “Emptying” will be displayed.
5. Drain the dialysate compartment. The dialyzer is empty as soon as there is air in the outlet line or an “Emptying stopped” message appears.
6. Open the shunt interlock door, remove the red dialyzer connector from the dialyzer and place it on the shunt. Close the shunt interlock door.
7. Discard the bloodlines, transducer protectors, and dialyzer according to facility policy.
8. Insert the concentrate wands into their proper rinse ports. The “Select Program” screen appears on the display screen.
9. Clean or disinfect the exterior of the machine according to routine cleaning and maintenance procedures described in “Disinfection and Maintenance,” on page 125.

Removing Bloodlines from the Machine

The arterial and venous ends of the bloodline should be clamped to avoid spillage before attempting to remove the lines from the system.



Caution: Do not forcefully pull the lines from the machine. Damage to the machine or its components may result.

To remove the bloodline from the blood pump, open the door and align the rotor by pressing and holding the **Start/Stop** key until the pump stops. Press the clamp-panel below the rotor to release the left (incoming) side of the pump segment. Pull the first couple of inches of the pump segment out of the pump. Then, while keeping firm tension outward on the left (incoming) side of the bloodline, press and hold the **Start/Stop** key a second time and the pump segment will be released from the pump head.

Be sure to open the door to the optical detector before pulling the line from the venous clamp and optical detector assembly.

Disinfection and Maintenance

This chapter covers all cleaning, disinfection, and maintenance tasks that can be performed by the operator. Included are instructions for running the programs found on the “Select Program” screen designed to clean and disinfect the fluid paths found in the 2008K² hemodialysis machine.

Cleaning and Disinfection

Daily cleaning, chemical, and heat disinfection procedures should be performed to maximize the efficiency and minimize bacterial levels within the system. All rinsing, cleaning, and disinfection programs are selected from the right side of the “Select Program” screen (see Figure 56 below). The “Select Program” screen appears automatically after a long power down or when the concentrate wands are inserted in their proper rinse ports after a treatment. The machine must be connected to an approved water source, the drain line connected to a drain, the dialysate supply lines on the shunt with the shunt interlock door closed, and the concentrate connectors are firmly seated in their respective ports. To run any of the Cleansing and Disinfection programs, select the appropriate button and press **CONFIRM**.

DISINFECTION/
MAINTENANCE

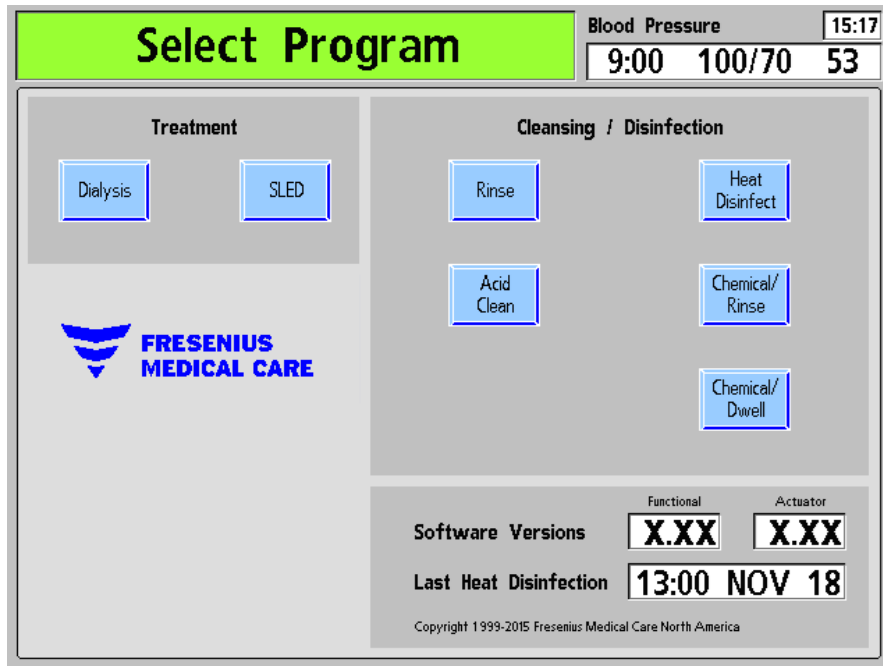

Figure 56 – The Select Program Screen

The fluid path of the 2008K² hemodialysis machine can be disinfected chemically or with heat. The machine should be rinsed thoroughly after chemical disinfection and before introducing any other chemicals to the machine. The machine should be disinfected at least once each day it is used and rinsed per unit protocol. If the machine is not in use for more than 48 hours, it should be disinfected before the next use or put in storage (for more information on storing the machine, see “Equipment Storage and Maintenance” on page 225). If there is evidence of a blood leak into the dialysate system, the machine should be disinfected before being used in any further treatments.

The Rinse program flushes the machine with water. The Acid Clean Program flushes the machine with a mild acid to remove bicarbonate build up. There are three options for disinfecting the interior of the 2008K² hemodialysis machine—Heat Disinfect, Chemical/Rinse and Chemical Dwell.



All rinse, cleaning, and disinfecting programs can be interrupted by pulling either concentrate nozzle from its rinse port or pressing the **Escape** key. Any Rinse or Disinfection program clears all SVS and UF parameters and resets them to default values. The ultrafiltration fluid sampler port output tubing is part of the fluid pathway; therefore, flow exists during cleaning and disinfection.



The following table describes the cleaning and disinfecting options available on the “Select Program” screen. Follow the current, chemical manufacturer’s instructions for the proper use of the disinfectants.

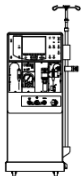

Warning! Any machine filled with a chemical for cleaning or disinfection must be clearly labeled by the operator. The label should identify the chemical used and state that the rinsing and testing for residual chemical are required before using the machine for treatment.

Table 30 – Cleaning and Disinfection Recommended Frequency

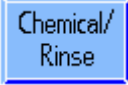
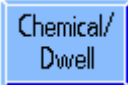
Procedure	Frequency	Description
 Page 130	Per Unit Protocol	The Rinse program flushes the hydraulic system with water. A rinse may be done between treatments and must be performed after a Chemical/Dwell procedure to eliminate residual disinfectant.
 Page 128	After Every Treatment	The exterior surface of the machine should be wiped down using a cloth and a disinfecting cleaner. Bloodlines and transducer protectors should be removed and disposed of in compliance with your unit’s biohazard waste guidelines. If there is evidence of contamination beyond the external transducer protector, disinfect the associated parts and replace the internal transducer protectors.
 Page 131	Daily	The Acid Clean button runs a program that flushes the machine with white distilled vinegar (5% acetic) or 2-5% citric acid for 10-60 minutes to prevent the build up of bicarbonate precipitate in the hydraulic system after a treatment. It is <u>not</u> a disinfecting procedure.
 Page 132	Daily	The Heat Disinfect button starts a program that disinfects the hydraulic system using water heated to about 80 °C. Heat Disinfect or Chemical/Rinse is recommended daily when the machine is used for treatment.

Procedure	Frequency	Description
 Page 133	Weekly	The Chemical / Rinse button runs a program that disinfects the hydraulic system using a chemical disinfectant followed by an immediate water rinse to clear the system of residual disinfectant. The Chemical / Rinse program should be used when disinfecting with corrosive chemicals, such as bleach, that could damage the hydraulic components if left in contact for prolonged periods.
 Page 135	Per Unit Protocol	The Chemical / Dwell program is designed for disinfecting the hydraulic system using a non-corrosive chemical disinfectant, such as formaldehyde. This program is intended for use with chemicals that are not harmful to the internal components after prolonged exposure and, hence, do not require the system to be rinsed with water immediately afterward.
 Page 128	Weekly	Clean and disinfect bicarbonate concentrate jugs and suction cap wands per facility protocol.

Additional Disinfection Requirements

In addition to the routine cleaning and disinfection tasks listed in the previous table, additional disinfection is required for the following situations:

- Each time the water treatment system is disinfected
 - When the water treatment system and distribution piping are disinfected, each dialysate delivery machine should be placed in the Rinse program to draw disinfectant into the machine through the inlet lines. Check for residual disinfectant prior to use for dialysis.
- After contamination of transducer protector
 - Disinfect the connectors and replace the internal transducer protector if there is evidence of leakage past the external transducer protector on the venous or blood pump modules. Disinfect associated parts.
- After a dialyzer blood leak
 - The machine should be disinfected prior to the next treatment if a blood leak alarm occurred.



Warning! The protocol for disinfection is determined by the facility and its medical director. When chemicals are used internally, machines must be thoroughly rinsed and tested for residual disinfectant before using the machine for treatment. Follow the instructions of the chemical manufacturer for residual testing. If the machine is chemically disinfected daily, we recommend that it also be heat disinfected at least once per week.

DISINFECTION/ MAINTENANCE

Cleaning the Exterior Surface

The exterior of the dialysis machine should be cleaned after every treatment. It can be cleaned with very dilute (1:100) bleach or other suitable hospital disinfectant. Use surface cleaning agents sparingly to avoid excess cleaner from entering the interior of the machine. After allowing the disinfectant to air dry, rinse it off with a water-dampened cloth, especially if a corrosive, cleaning agent such as bleach is used.

Freshly prepared dilute bleach solution (1:100) is currently recommended by the Center for Disease Control as a suitable disinfectant for the Hepatitis virus. Because surface contamination is the general mode of transmission for this type of virus, thorough cleaning of the 2008K² hemodialysis machine exterior is essential.



Caution: Do not use foaming type cleansers or disinfectants containing quaternary ammonium compounds like N-alkyl (C₁₂ – C₁₈) dimethyl benzyl ammonium chloride. These ingredients attack the polycarbonate plastics used in the machine.

If a blood leak occurs inside the blood pump module, make sure to clean around the blood pump rotor. Unlatch and remove the rotor during cleaning.

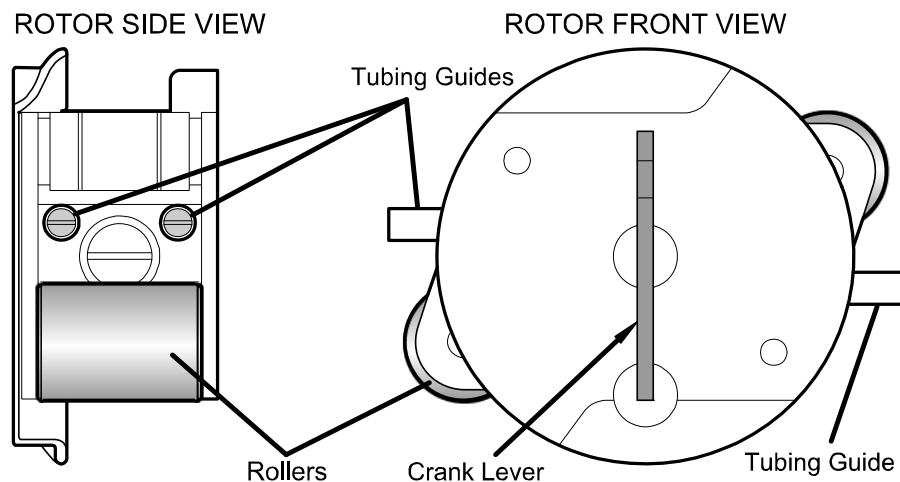

Figure 57 – The Blood Pump Rotor



Warning! Inspect the blood pump rotor for proper operation (tubing guide posts not bent, rollers move freely, crank lever moves freely). Bent or loose tubing guide posts can damage bloodlines. Replace rotor if necessary.

Concentrate Containers

The containers used for bicarbonate concentrate should be disinfected once a week. Dilute 1:100 bleach may be used for this purpose. This is especially important when bicarbonate concentrates are used since bacteria can grow more readily in these solutions. Following disinfection, they should be rinsed thoroughly with treated water. Check for residual disinfectant before using the disinfected containers. All concentrate containers should be left empty (shake if necessary) and inverted when stored overnight.

Cleaning the Blood Pressure Cuff

Remove the rubber inflation bag from the Dacron cuff. Both may be disinfected with commercially available disinfectant soaks. Some disinfectants may cause skin irritation. Rinse thoroughly to remove any residual disinfectant. Follow the manufacturer's instructions. Caution is advised when using dark colored soaks which may stain the cuff. Test a single cuff to ensure that no damage will occur. EtO sterilization may be used.



Caution: If a chlorine bleach solution is used to clean the blood pressure cuff, the service life of the cuff will be reduced. Do not autoclave the cuff.

Hand washing will enhance the service life of the Calibrated V-Lok cuff. Remove the natural rubber inflation bag and wash the cuff in warm soapy water; then rinse thoroughly. Allow the cuff to air dry and then insert the inflation bag. When using machine washing, be sure that the hook and loop fasteners are engaged so that the hooks do not collect lint or other fibers. These fasteners can melt at temperatures above 325 °F (132 °C), when being ironed or pressed.

Water Supply Maintenance

It is recommended that the bacterial quality of both the water and the dialysate be checked on a routine basis. These checks should take place just before routine disinfection of the system. Follow the manufacturer's instructions for the operation and storage of reverse-osmosis (RO) and water pre-treatment equipment.

All sections of the treated water feed system and dialysate delivery machine must be disinfected regularly to minimize bacterial levels. Each time the treated water system and distribution piping are disinfected, the dialysis machines should be put into Rinse program. This allows the disinfectant chemical to feed through the inlet system. Test the water for residual disinfectant prior to use for dialysis.



Note: The water inlet line is part of the water distribution system and is not disinfected by the dialysis machine. With some RO systems, the water inlet line may be disinfected along with the RO and distribution piping by leaving the dialysis machine in Rinse mode during RO disinfection.

Rinse Program

The Rinse program may be run before each treatment and must be run after performing a chemical disinfection. The length of the rinse cycle is determined through an internal setting, and can be set to run for 10 to 60 minutes. The Rinse program is run with the dialysate supply lines on the shunt and the concentrate connectors inserted in their respective ports. The program performs a complete rinsing of the dialysate circuit and concentrate suction lines.

If the machine has been idle for more than 48 hours after being rinsed, we recommend a disinfection cycle prior to use.

To run the Rinse program:

1. Ensure that both dialysate lines are on the shunt and both concentrate connectors are in their respective ports.
2. From the “Select Program” screen, select **Rinse** and press the **CONFIRM** key.
3. The “Rinse” screen appears in the display (see Figure 58).
4. Press **CONFIRM** to exit when Rinse has completed.

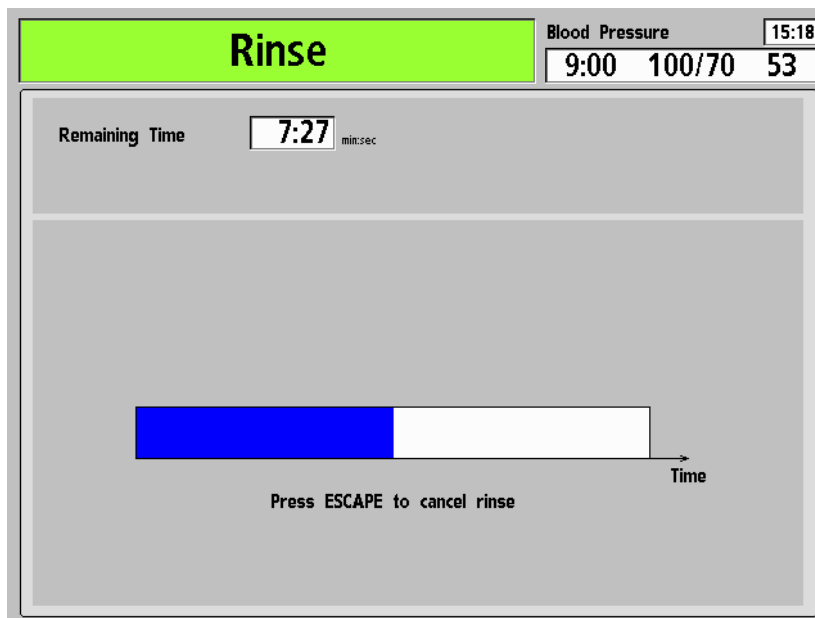

Figure 58 – The Rinse Screen

At the end of the Rinse program, the machine will display the message, “Press CONFIRM to exit.”

If the rinse cycle followed chemical disinfection, the water from the rear drain must be tested to ensure that residual disinfectant has been reduced to an acceptable level.

Acid Clean Program

The 2008K² hemodialysis machine should undergo an acid cleaning daily when using bicarbonate concentrates during dialysis. The purpose of the Acid Clean program is to prevent the buildup of bicarbonates inside the machine that can have a detrimental effect on the machine's performance and treatment efficacy. **The Acid Clean program is not a method of disinfection.**

Acid Cleaning can be accomplished using white distilled vinegar (5% acetic acid) or 2-5% citric acid.

To run the Acid Clean program:

1. Attach a sign to the front of the machine that identifies the chemical being used to acid clean the machine.
2. Ensure that both dialysate lines are on the shunt and both concentrate connectors are in their respective ports.
3. From the “Select Program” screen, select **Acid Clean** and press the **CONFIRM** key.
4. Message “Wait: Rinsing Line” appears.
5. Attach the acid and bicarbonate connectors to a jug (s) containing an acid cleaner when prompted.
6. Press **CONFIRM** to start the Acid Clean program. The “Acid Clean” screen appears in the display (see Figure 59 – The Acid Clean Screen). The progress of the acid cleaning is indicated by the horizontal bar.
7. Return connectors to their ports when prompted.
8. Press **CONFIRM** to exit.

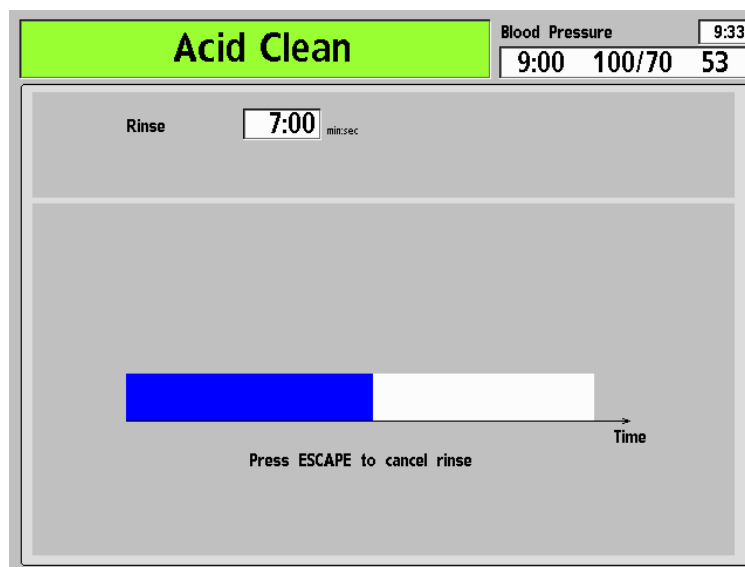

Figure 59 – The Acid Clean Screen

Heat Disinfection

The Heat Disinfect program disinfects the machine by running hot water (about 80 °C) through the machine. The water recirculates at a program-controlled flow of about 400 ml/min. The program time can be set internally to run between 10 and 60 minutes. The timer starts as soon as the temperature of the water reaches 80 °C.

To run the Heat Disinfect program:

1. Ensure that both dialysate lines are on the shunt and both concentrate connectors are in their respective ports.
2. From the “Select Program” screen, select **Heat Disinfect** and press the **CONFIRM** key to start the Heat Disinfect program. The “Heat Disinfect” screen appears in the control panel display (see Figure 60). If the machine was not rinsed prior to this, it will automatically run a short rinse (seven minutes) or an extended rinse (20 minutes) depending on how the machine was configured in Service Mode.

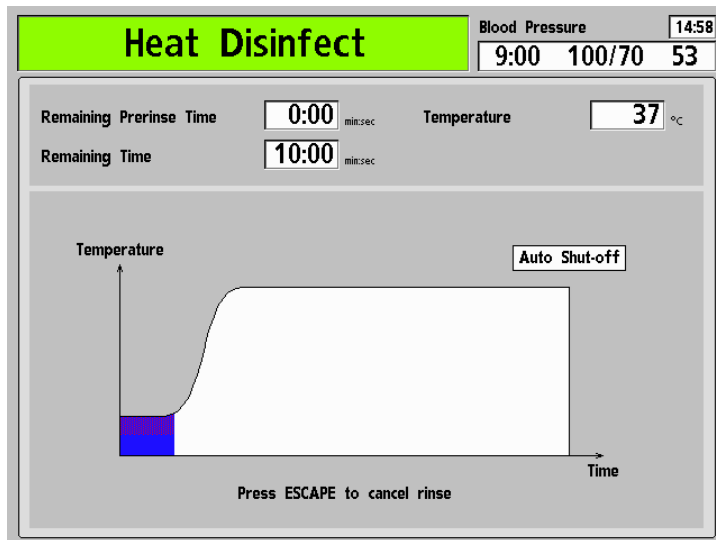

Figure 60 – The Heat Disinfection Screen



Warning! During the heat disinfection cycle, it is not uncommon to see steam emitting from the vent tubing at the back of the machine. This steam may cause burns if contacted. Also, the temperature of the dialysate lines and drain line can get as hot as 69 °C (156 °F). Please use care.

3. After the heat disinfection is complete, if the machine is not configured to automatically turn off at the completion of the cycle, press **CONFIRM** to exit when prompted.



Note: The drain line is subjected to a lower temperature and shorter heat cycle than the rest of the machine. If you are unable to completely clean biofilm from the drain line, select the “Extended Pre-rinse” option in Service Mode. If necessary, replace the drain line.

Note: Cooling time can be shortened by running the Rinse program, which will flush the machine with 37 °C water. Do not cool the machine with the Rinse program unless the machine will be used immediately afterwards.

Chemical/Rinse Program

The Chemical/Rinse program should be used when disinfecting the hydraulic system using corrosive chemicals, such as bleach. The Chemical/Rinse program consists of a disinfection cycle followed by a water rinse cycle. Because bacterial growth can begin soon after the rinse cycle, the machine should be disinfected again if it has remained idle more than 48 hours after its previous disinfection.



Caution: To avoid internal damage these chemicals should not remain in contact with the machine. Rinse your machine immediately after completing the disinfection.

To run the Chemical/Rinse program:

1. Attach a sign to the front of the machine that identifies the chemical being used to disinfect the machine.
2. Ensure that both dialysate lines are on the shunt and both concentrate connectors are in their respective ports.
3. From the “Select Program” screen, select **Chemical/Rinse** and press the **CONFIRM** key.
4. The “Chemical/Rinse” screen appears in the display (see Figure 61). The progress of the disinfection program is indicated by the horizontal bar. The program starts with a 45 second pre-rinse. The message, “Rinsing Lines, Please Wait” is displayed in the Status Box.



Note: If the ‘HE Leak Test’ Service Mode option is selected, the machine will run a four minute pressure holding test after the 45 second pre-rinse. If the first test fails, a second test will automatically run.

If the second test fails, the machine will display a “System Leak, Can’t Run” message, meaning that the Chemical/Rinse program can no longer be run due to a leak detected in the Heat Exchanger. However, the machine will still be able to run Heat Disinfection programs and hemodialysis treatments per unit protocol. Call a qualified service technician.

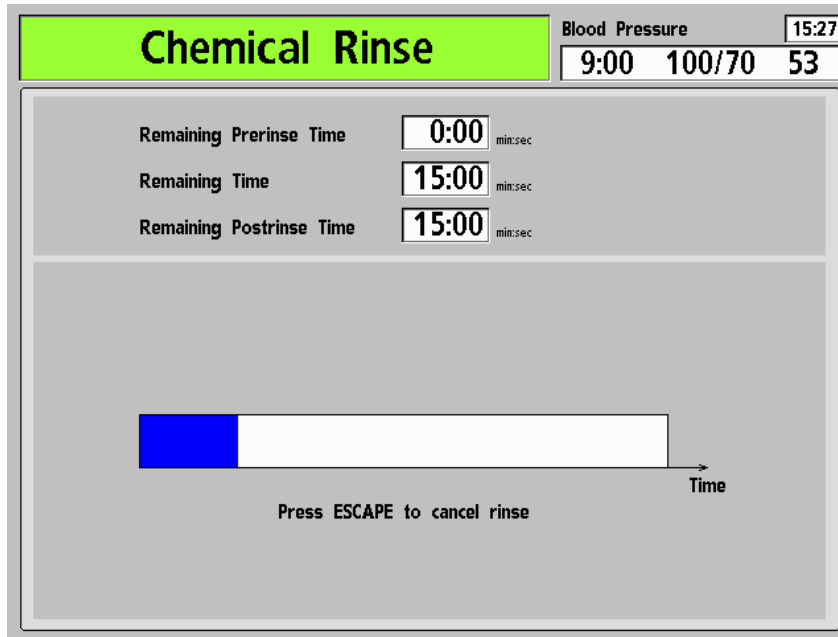

Figure 61 – The Chemical Rinse Screen

5. Connect the red connector to a jug containing the chemical disinfectant and press **CONFIRM** when prompted.
6. Water pre-rinse will start. Remaining Pre-rinse Time meter box will count down.
7. When Remaining Pre-rinse Time meter box reads 0:00, chemical rinse will start after a delay. Remaining Time meter box will count down.



Note: Visually confirm that disinfectant has been pulled into the machine.

8. When the Remaining Time meter box reads: 0:00, remove the acid connector from the disinfectant jug and insert it into the acid rinse port when prompted. Post rinse will start and Remaining Post Rinse Time meter box counts down.
9. Press **CONFIRM** to exit.



Warning! Test for residual disinfectant prior to starting treatment following a chemical disinfection.



Note: The machine will automatically perform a Diasafe test after the Chemical Rinse program completes.

Chemical/Dwell Program

The Chemical/Dwell program should be used when disinfecting the hydraulic system using chemical disinfectants that can remain in contact with internal components for prolonged periods without damaging them. Formaldehyde can be used with the Chemical/Dwell program for maximum effectiveness.

To run the Chemical/Dwell program:

1. Attach a sign to the front of the machine that identifies the chemical being used to disinfect the machine.
2. Ensure that both dialysate lines are on the shunt, and both concentrate connectors are in their respective ports.
3. Place the concentrated disinfectant in the small container with the yellow cap.
4. From the “Select Program” screen, select **Chemical/Dwell** and press **CONFIRM**.

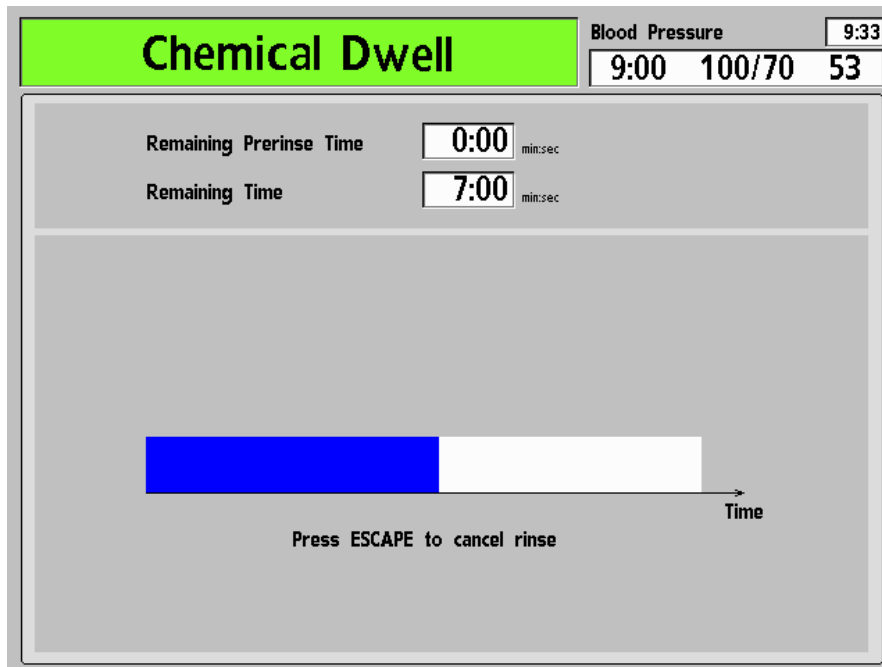

Figure 62 – The Chemical/Dwell Screen

5. The “Chemical/Dwell” screen appears in the display (see Figure 62). The progress of the disinfection program is indicated by the horizontal bar. The program starts with a 45 second rinse. The message, “Rinsing Line, Please Wait” is displayed in the Status Box.
6. When prompted, connect red connector to chemical disinfectant. Press **CONFIRM**.
7. Water Pre-rinse will start. Remaining Pre-rinse Time meter box counts down.

8. Chemical dwell follows after a delay. Remaining Time meter box counts down.
9. When the Remaining Time meter box reads 0:00, remove the red acid connector from the disinfectant jug and insert it into the acid rinse port. The machine will automatically run for about a minute to draw up the disinfectant left in the tubing.



Note: Visually confirm that disinfectant has been pulled into the machine.

10. Following the completion of the chemical disinfection cycle, “Press CONFIRM to exit” will display in the Status Line.
11. Press **CONFIRM** to exit.



Warning! The mandatory rinse cycle must be completed and a test for residual disinfectant must be performed prior to the next treatment.

Testing for Disinfectant

After a chemical disinfection cycle, the machine must be checked for residual disinfectant before initiating dialysis. A sample for testing for residual disinfectant can be obtained from a dialysate line or the drain line.

Table 31 – Disinfectant Detection Methods

Disinfectant	Detection Method
Formaldehyde	Using Schiff's reagent or a commercially available formaldehyde test, measure the residual formaldehyde according to the manufacturer's directions. The level of formaldehyde should be less than 5 ppm.
Bleach	Use facility protocol for detecting chlorine levels in the fluid sample.
Diacide HD	Test according to the manufacturer's instructions using Nephrect or another test intended for this product.

Power Failure During Chemical Disinfection

If a Chemical/Rinse or Chemical/Dwell program is interrupted, the machine will only allow Rinse, Chemical/Rinse, or Chemical/Dwell to be selected from the “Select Program” Screen when power is restored. A message “Mandatory Rinse” will be displayed after the **Rinse** button is selected and confirmed.

If a mandatory rinse cycle is interrupted by a power failure, only a Rinse program is available in the “Select Program” screen. The entire Rinse program must be completed before the operator can initiate dialysis.

Alarms and Troubleshooting

This chapter covers atypical situations such as alarm and warning events that can occur during treatment. At the end of this chapter are also procedures for testing the Diasafe Filter and replacing the power failure alarm battery.

Operational Status

The 2008K² hemodialysis machine is equipped with a system of electronic components and diagnostic software that monitor its operation and performance. When problems or potential problems are detected, the operator is alerted through informational messages displayed on the screen and in some cases, audible alarms. Audible alarms are suppressed however, when the dialysate supply lines are on the shunt, providing no blood is sensed.

The informational messages are displayed in two places in each treatment screen: the Status Box and the Dialogue Box. The Status Box is present in every screen. The Dialogue Box appears in place of the Time and Blood Pressure displays in situations requiring input from the operator.

The Status Box is a rectangular box found in the upper left corner of every screen (see Figure 63). The message in it describes the current mode of the machine or a problem during treatment. There are three operational conditions or statuses: Normal, Warning, and Alarm. The background color of the Status Box changes color to accentuate the operational status. Depending on the options chosen, machines that are equipped with a status beacon may illuminate the light to alert the user of the machine status.



Warning! All alarms need your immediate attention. Failure to do so may cause serious injury or death.

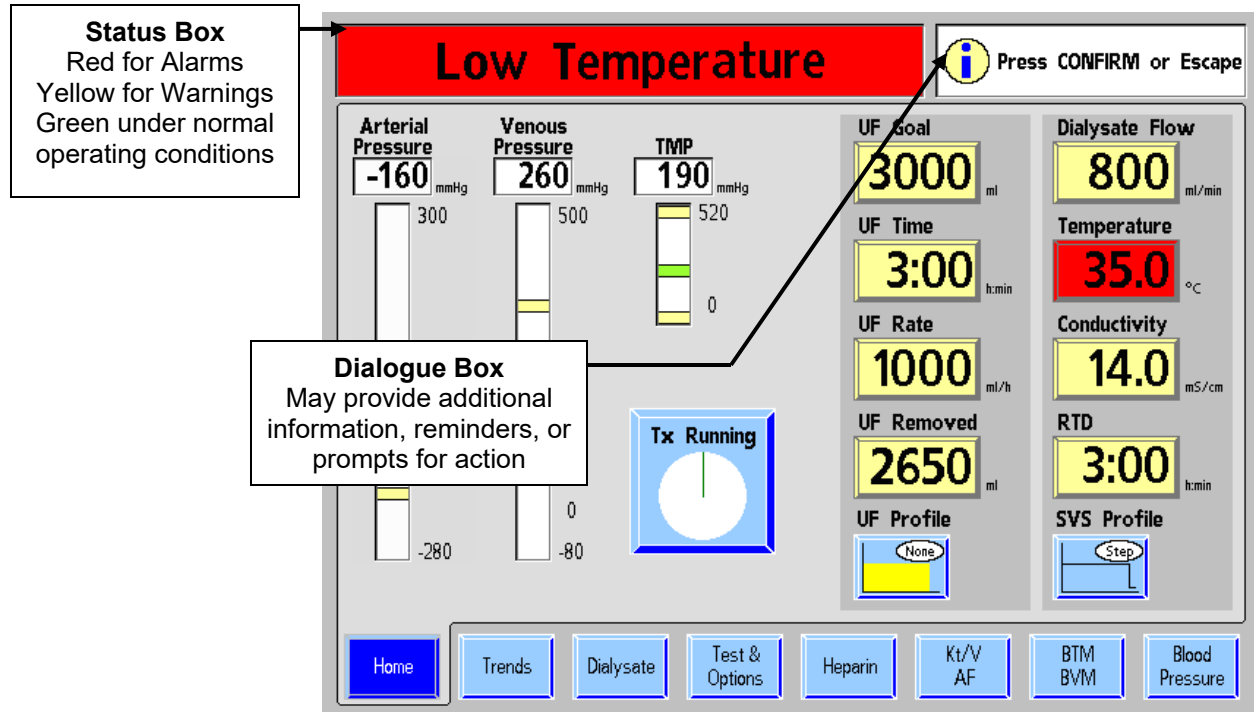

Figure 63 – Status Box and Dialogue Box during an Alarm Event

The Dialogue Box, found in the upper right corner of the display screens, can provide information on the patient, prompt an action, or serve as a reminder. The Dialogue Box can appear alone or supplement the message displayed in the Status Box during a Warning condition. In some cases, Dialogue Boxes, if ignored for a prolonged period, can trigger a Warning message in the Status Box. Although a Dialogue Box can appear during a Warning or Alarm event, the messages displayed in each may represent two separate, unrelated issues.

Normal Status

The Status Box displays a green background under normal operation when no problems have been detected. During dialysis operation, the Status box will display a message describing the current mode of the machine: Dialysis or SLED. When a Dialogue Box message is not displayed, the Dialogue Box displays the current time, patient blood pressure and pulse and the time taken.

Warning Status

The Status Box background changes to yellow when a Warning Status condition exists. Warning Status conditions do not pose an immediate threat to the patient but do require action by the user. Warning events do not stop the blood pump. The message displayed in the Status Box is intended to alert the operator of a functional anomaly, a procedural error, or an existing condition requiring remedial action. A Warning Status may be accompanied by an audible alarm.

Alarm Status

Alarm situations require the immediate attention of the operator. Under these circumstances, the background of the Status Box turns bright red. An audible alarm also accompanies these alarm events.

There are three types of Alarm events:

- Blood Alarms
- Water/Dialysate Alarms
- Other



Note: The 2008K² hemodialysis machine may be configured to suppress all audible alarms until blood is sensed in the venous line by the optical sensor below the venous clamp assembly. In these machines, the audible alarms occur only if the dialysate lines are off the shunt and blood is sensed by the optical detector. This option is activated internally by a qualified technician, and is the prerogative of the Medical Director. Otherwise, alarms are always audible once the dialysate lines are off the shunt.

Blood Alarms

Blood alarm events have the highest priority. When a blood alarm occurs:

- The blood pump stops
- The venous clamp on the level detector occludes
- The UF pump stops
- RTD stops

There are several features on the 2008K² hemodialysis machine control panel that you should be familiar with in the event of a blood alarm. Figure 64 – Control Panel Features for Blood Alarms identifies the location of each of them. The accompanying table describes the function of each feature.

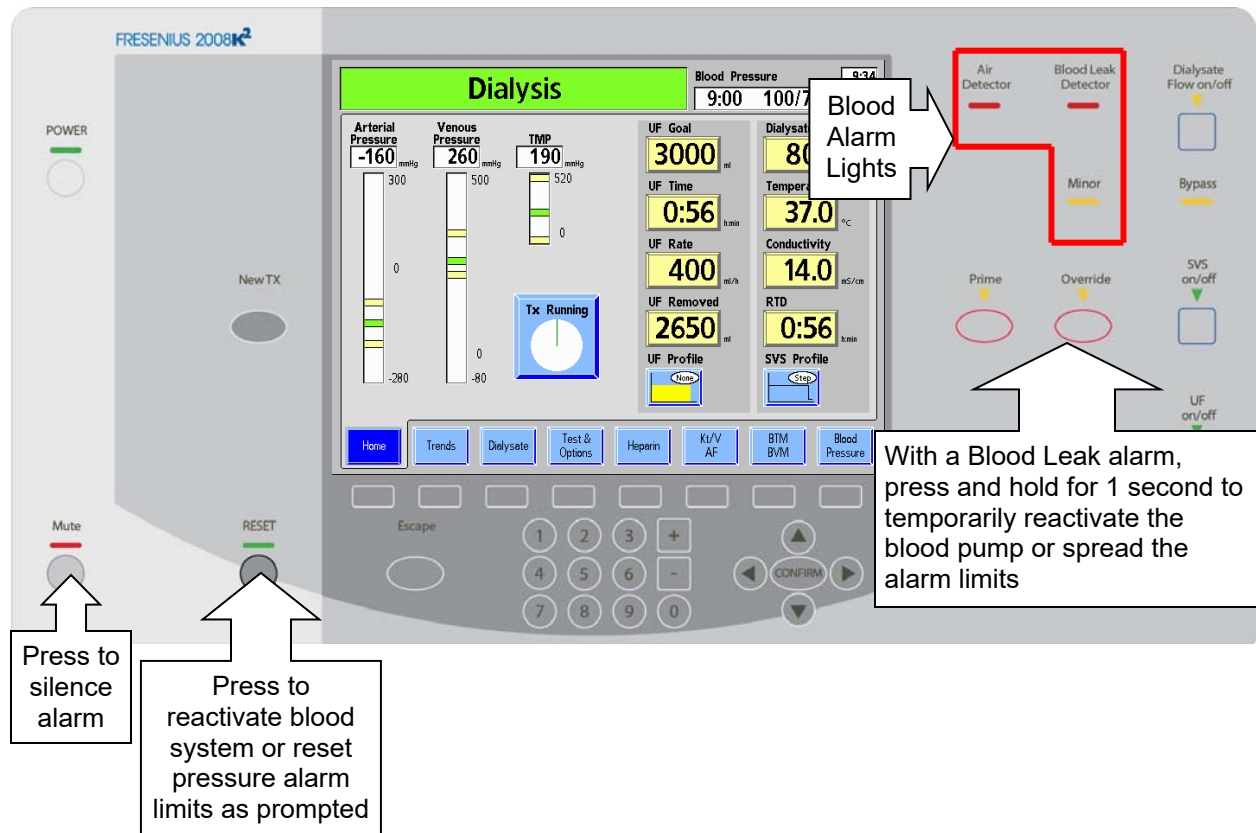





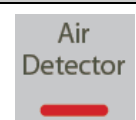
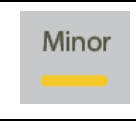

Figure 64 – Control Panel Features for Blood Alarms

Table 32 – The Control Panel Keys Used During Alarms

Press...	To...
	Silence an alarm for two minutes or until another alarm event occurs. The red Mute light illuminates.
	Keep the blood pump running for three minutes when a blood-leak alarm is present. The yellow Override light will illuminate. OR If a blood leak alarm is not present, pressing and holding the Override key for one second will spread the arterial and venous alarm limits 300 mmHg and the TMP alarm limits are spread fully open for 30 seconds. The Override light will not illuminate.
	Reset to clear blood alarms. Pressing once will reactivate the blood pump. If offered, press and hold a second time to reset arterial, venous, and transmembrane (TMP) limits. This requires pressing RESET twice within eight seconds with the second RESET being held for a full second. If there is no blood alarm present, pressing and holding this key for one full second will re-center the arterial and venous alarm limits.

ALARMS TROUBLE-SHOOTING

Table 33 – Control Panel Indicator Lights

An illuminated...	Means...
	Level deficiency has been detected in the venous drip chamber.
	A minor blood leak (approximately 0.35 - 0.45 ml/min) or air has been detected by the blood leak detector in the dialysate return line.
	A larger blood leak (> 0.45 ml/min) has been detected by the blood leak detector in the dialysate return line.

Water/Dialysate Alarms

During a water/dialysate alarm (temperature or conductivity), the blood system continues to operate, but the dialysate fluid is internally bypassed around the dialyzer. This can be verified by visually inspecting the flow meter in the dialysate supply line. During bypass, the float will remain stationary at the bottom of the sight glass. Any time the machine is in bypass, the bypass indicator light is illuminated.

A flow alarm will not cause the machine to go into bypass. Water/dialysate alarms are self-resetting when the alarm condition is corrected. Temperature and conductivity alarms do not occur during the Isolated UF mode of Sequential dialysis when there is no dialysate flow.

Other Alarms

Other alarms may be associated with other components, such as the Heparin or UF pumps, BPM, BVM, BTM, etc.

Troubleshooting

All status messages (operational alarms, warnings, dialogues, and advisories) are displayed on the control panel screen. These messages are generated due to conditions and events that occur in the machine during operation. These messages will reset when the condition causing the message is corrected. In some cases, the operator must reset them.

The table following this section is indexed by Status Box message. The table consists of four columns:

- Status Box Message
- Message Purpose
- Message Type
- Action Required

Status Box Message

The Status Box Message column identifies the message as it appears in the Status Box or in the Dialogue Box of the display screen.

Purpose of Message

The Purpose of Message column is a brief explanation of the Status Box message or the condition that generated it.

Type

The Type column identifies the message as an alarm, a warning, a dialog, or an advisory. An alarm message requires immediate attention. It is accompanied by a visual indicator and an audible alarm sound. A warning message notifies the user of an existing condition. It could be accompanied by an audible alarm. An advisory message prompts the operator to take a specific action in a procedure or informs the operator that a particular machine operation is in progress. Many advisories require no action on the part of the operator.

Action Required

The Action Required column provides recommended actions in response to a given Status Box message. In addition, your unit might require other patient-specific treatment actions that are not listed here. It is each care unit's responsibility to ensure that their operators are made aware of the unit's protocol in these matters.

If performing the recommended action does not clear the Status Box message displayed, treatment should be discontinued until the conditions causing the message are corrected and the message cleared. In rare cases, it may be necessary to turn the machine off and back on to clear an error condition. If problems persist, the machine should be referred to a qualified technician for inspection.



Warning! Performing the recommended action may or may not clear the alarm, warning or advisory messages displayed. Patient treatment shall not proceed until the conditions causing these messages are corrected and the messages cleared. If a machine must be taken out of service, the operator should return the blood to the patient if possible and disconnect the patient from the machine. Follow unit protocol to rinse back the blood using the blood pump or see “Manually Operating the Blood Pump” on page 119 for more information.



Note: Recommendations to take a machine out of service refer to assuring that the machine is not used for patient treatment until conditions causing alarms and warnings are resolved. Specific operator action in these cases is to refer the machine, and its associated problems, to a qualified local technician for inspection, testing, and troubleshooting.

Note: If the 2008K² hemodialysis machine becomes unresponsive (locks-up or ‘freezes’) or if the display screen unexpectedly turns off, turn off the machine by pressing and holding the **Power** key for one second. Press the **Power** key again to restart the machine.

Message	Purpose of Message	Type	Action Required
# of Tests has been set to min	The operator has attempted to set the number of Online Clearance (OLC) tests lower than allowed.	Dialog Message	The machine has set the number of tests to the lowest value allowed. Verify that the number of OLC tests is acceptable. See page 105 for more information.
5 Minutes Flow Off	Dialysate flow has been off for five minutes.	Warning	<ol style="list-style-type: none"> 1) Press RESET to silence the alarm. 2) If you intend for the flow to be off, set the Dialysate Flow button to Seq(ue[n]tial). Otherwise, turn on the dialysate flow with the On/Off key.
*** 5V HIGH ***	Electronic self-test, power supply limits exceeded.	Alarm	Turn machine power off and back on. If alarm is not cleared, take the machine out of service and alert a qualified service technician.
*** 5V LOW ***	Electronic self-test, power supply limits exceeded.	Alarm	Turn machine power off and back on. If alarm is not cleared, take the machine out of service and alert a qualified service technician.
10 Fill Pgm in 1 hr	Ten fill programs have occurred during a one-hour period.	Warning	<ol style="list-style-type: none"> 1) Check the dialyzer supply and return lines, especially around the connectors and dialysate filter in the dialyzer return line, for air entering the system and correct the problem. 2) Press RESET to clear the alarm. If unable to reset the alarm, return the blood to the patient, take the machine out of service and replace the machine with another machine. Alert a qualified service technician.
			 Note: Using a conventional dialyzer at a high UF rate can cause frequent Fill programs because of a high TMP. Lowering the UF rate by decreasing the UF Goal may solve the problem. Notify a physician if the UF goal has changed.
12V POWER FAIL	Electronic self-test, power supply limits exceeded.	Alarm	Turn machine power off and back on. If alarm is not cleared, take the machine out of service and alert a qualified service technician.
*** 24 V HIGH	Electronic self-test, power supply limits exceeded.	Alarm	Turn machine power off and back on. If alarm is not cleared, take the machine out of service and alert a qualified service technician.
*** 24V LOW	Electronic self-test, power supply limits exceeded.	Alarm	Turn machine power off and back on. If alarm is not cleared, take the machine out of service and alert a qualified service technician.

60 Minutes Flow Off	Dialysate flow has been off for 60 minutes in the sequential option.	Warning	Press the RESET key to clear the alarm. Isolated UF will continue for the remainder of the prescribed treatment time. To cancel Isolated UF and perform hemodialysis to comply with the prescribed treatment, set dialysate flow to the prescribed rate using the data entry keypad, press CONFIRM , and start the dialysate flow by pressing the Dialysate Flow on/off key on the control panel. The machine will go into bypass mode until dialysate temperature and conductivity settings are attained (about two minutes). Dialysate flow must be re-established for a minimum of five minutes before resuming Isolated UF or the warning will reoccur.
A.11 (Arterial or SN Blood Pump Message)	Pump is not reaching speed at maximum voltage	Alarm	Press the RESET key to clear. If problem persists, return the blood to the patient if alarm occurs during treatment. Take blood pump module out of service and alert a qualified technician.
A.13 (Arterial or SN Blood Pump Message)	Pump is turning in the wrong direction	Alarm	Press the RESET key to clear. Verify pump rotor is turning in a clockwise direction. If not, manually return the blood to the patient if alarm occurs during treatment (see page 119 for instructions). Take blood pump out of service and alert a qualified service technician.
A.16 (Arterial or SN Blood Pump Message)	Key stuck or held in too long	Alarm	Press the RESET key to clear. Verify when adjusting settings, the operator does not hold the key too long. If problem persists, return the blood to the patient if alarm occurs during treatment. Take blood pump module out of service and alert a qualified service technician.
A.20 (Arterial or SN Blood Pump Message)	Set speed-read back analog voltage at X348/14 is out of limits	Alarm	Press the RESET key to clear. If problem persists, return the blood to the patient if alarm occurs during treatment. Take blood pump module out of service and alert a qualified service technician.
A.21 (Arterial or SN Blood Pump Message)	Actual speed-read back analog voltage at X348/10 is out of limits	Alarm	Press the RESET key to clear. If problem persists, return the blood to the patient if alarm occurs during treatment. Take blood pump module out of service and alert a qualified service technician.
A.22 (Arterial or SN Blood Pump Message)	Arterial pressure-read back analog voltage at X348/7 is out of limits SN pressure-read back analog voltage is out of limits	Alarm	Press the RESET key to clear. If problem persists, return the blood to the patient if alarm occurs during treatment. Take blood pump module out of service and alert a qualified service technician.
A.24 (Arterial or SN Blood Pump Message)	Optical tachometer not in range	Alarm	Press the RESET key to clear. If problem persists, return the blood to the patient if alarm occurs during treatment. Take blood pump module out of service and alert a qualified service technician.



Message	Purpose of Message	Type	Action Required
A.25 (Arterial or SN Blood Pump Message)	Pressure increase when the Level Up key is pressed	Alarm	Press the RESET key to clear. Possibility that the level adjust pump is connected backward so that the level is lowered instead of raised. Verify that the level in the arterial chamber rises when the adjust key is pressed. If it does not, return the blood to the patient if alarm occurs during a treatment. Take the machine out of service and alert a qualified service technician.
A.26 (Arterial Blood Pump Message)	Pressure was adjusted too much in calibration mode	Alarm	Press the RESET key if this message occurs in Dialysis Mode. If this alarm occurs during a treatment, return the blood to the patient. Take the blood pump module out of service and alert a qualified service technician.
A.27 (Arterial Blood Pump Message)	Time out when receiving Intel-Hex-line or overflowed received buffer	Alarm	Press the RESET key if this message occurs in Dialysis Mode. If this alarm occurs during a treatment, return the blood to the patient. Take the blood pump module out of service and alert a qualified service technician.
A.28 (Arterial Blood Pump Message)	Error in received Intel-Hex-line	Alarm	Press the RESET key if this message occurs in Dialysis Mode. If this alarm occurs during a treatment, return the blood to the patient. Take the blood pump module out of service and alert a qualified service technician.
A.29 (Arterial Blood Pump Message)	Pump rotor turning when it should not be	Alarm	Press the RESET key to clear. If problem persists, manually return the blood to the patient (see page 119 for instructions). Take blood pump module out of service and alert a qualified service technician.
Access Flow Complete	This message is an advisory message that the Access Flow test is complete	Warning	Press CONFIRM to clear the message
Access Flow Running	This message is an advisory message that the Access Flow test process is continuing.	Advisory	No action is necessary
Access Flow Test Scheduled	This message is an advisory message that the Access Flow test process is continuing.	Advisory	No action is necessary
Acetate Selected!	Acetate concentrate has been selected and the blue bicarbonate wand/connector is out of its port.	Warning	Connect blue (bicarbonate) wand/connector into the blue rinse port. Be sure the concentrate selection is correct.

Acid Pump Alarm	This is a pump failure warning.	Warning	A single occurrence is not a problem if the machine automatically resets. If the problem persists for longer than one minute or occurs repeatedly, turn power off and back on. If warning is not cleared, return the blood to the patient if alarm occurs during treatment. Take the machine out of service and alert a qualified service technician.
Acid Pump Always EOS	This is a pump failure warning.	Warning	A single occurrence is not a problem if the machine automatically resets. If the problem persists for longer than one minute or occurs repeatedly, turn power off and back on. If warning is not cleared, return the blood to the patient if alarm occurs during treatment. Take the machine out of service and alert a qualified service technician.
Acid Pump No EOS	This is a pump failure warning.	Warning	A single occurrence is not a problem if the machine automatically resets. If the problem persists for longer than one minute or occurs repeatedly, turn power off and back on. If warning is not cleared, return the blood to the patient if alarm occurs during treatment. Take the machine out of service and alert a qualified service technician.
Act Blood Pump Failed	Electronic self-test failure.	Alarm	Turn machine power off and back on. If alarm is not cleared, return the blood to the patient if alarm occurs during treatment. Take the machine out of service and alert a qualified service technician.
Act Board CRC Error	Electronic self-test failure.	Alarm	Turn machine power off and back on. If alarm is not cleared, return the blood to the patient if alarm occurs during treatment. Take the machine out of service and alert a qualified service technician.
Act BYP Valve Fail 1	Electronic self-test failure.	Alarm	Turn machine power off and back on. If alarm is not cleared, return the blood to the patient if alarm occurs during treatment. Take the machine out of service and alert a qualified service technician.
Act BYP Valve Fail 2	Electronic self-test failure.	Alarm	Turn machine power off and back on. If alarm is not cleared, return the blood to the patient if alarm occurs during treatment. Take the machine out of service and alert a qualified service technician.
Actuator BD no Echo	Functional to Actuator board communication problem	Alarm	Turn machine power off and back on. If alarm is not cleared, return the blood to the patient if alarm occurs during treatment. Take the machine out of service and alert a qualified service technician.
Actuator Board Software needs upgrade	The Functional Board Software and Actuator-Test Board Software are not matched	Opening Screen Message	Turn the machine off and try to power up again. If the message repeats, take the machine out of service and alert a qualified service technician.

Message	Purpose of Message	Type	Action Required
Adjusting TMP	The operator has chosen to relieve the TMP after a TMP alarm	Advisory	No action necessary.
Air Detector Alarm	The level of blood in the venous drip chamber is too low.	Blood Alarm	<ol style="list-style-type: none"> 1) Inspect the venous drip chamber and level detector module to see if: <ul style="list-style-type: none"> • There is an adequate level of blood (approximately $\frac{3}{4}$ full) in chamber. • The venous drip chamber is properly mounted in its holder. • The venous drip chamber is positioned with the mesh filter below the level detection sensors. • The sensors are clean (if not, clean with an alcohol pad). • The Level Detector door is closed and latched 1) Raise blood level by pressing and holding the Δ (up) key on the level detector until the chamber is approximately $\frac{3}{4}$ full. 2) Press the RESET key to reset the alarm. If unable to reset alarm, return the blood to the patient and take the machine out of service. Have a qualified service technician recalibrate for the type of bloodline used. <div style="text-align: right;">  <p>Warning! Ensure that air will not be infused into the patient when the blood flow is re-established.</p> </div>
Alarm Test Failed	The Alarm Test section of the Automated Test Sequence has failed.	Alarm	Press the RESET key once to mute the alarm; pressing it a second time resets the right side of the screen. Retest. If the machine fails on retest, take the machine out of service and alert a qualified service technician.
Art. BP no comm.	The blood pump module has lost communication with the machine	Alarm	Turn machine power Off and back On. If alarm is not cleared, manually return the blood to the patient if the alarm occurs during treatment (see page 119 for instructions). Take the machine out of service and alert a qualified service technician.

Art. Pressure Alarm (with the upper Arterial Pressure Alarm limit flashing)	The pressure inside the arterial drip chamber is above the set alarm limits.	Blood Alarm	<ol style="list-style-type: none"> 1) Check arterial and venous tubing for kinked line, clotting or clamps. 2) Ensure that the transducer protector is dry and the monitor line is open. Replace transducer protector, if necessary. 3) Check for clotted fibers in the dialyzer 4) Check to see if blood flow rate is too high, especially with a pre-pump monitor. 5) Press RESET to reset alarm. If applicable, press RESET again and hold for one second to select new alarm limits. 6) If unable to reset the alarm, return blood to the patient if possible. Do not return clotted blood to the patient. 7) Take the machine out of service and alert a qualified service technician.
Art. Pressure Alarm (with the lower Arterial Pressure Alarm limit flashing)	The pressure inside the arterial drip chamber is below the set alarm limits	Blood Alarm	<ol style="list-style-type: none"> 1) Check the arterial tubing for kinks, clotting, or clamps. 2) Check the needle position and access patency. 3) Ensure that the transducer protector is dry and the monitor line is open. Replace transducer protector, if necessary. 4) Check to see if blood flow rate is too high, especially with a post-pump monitor. <div data-bbox="1119 980 1220 1078" style="border: 1px solid black; border-radius: 50%; width: 40px; height: 40px; display: flex; align-items: center; justify-content: center; margin-bottom: 10px;"> i </div> <p data-bbox="1251 980 1934 1166">Note: Pre-pump arterial monitoring is very sensitive to access problems (e.g., access spasms, needle tip occlusions from patient movement). A slower blood pump rate will bring the pre-pump arterial pressure up. Assess whether the patient's access is capable of delivering the prescribed blood flow.</p> <ol style="list-style-type: none"> 5) Press the RESET key to reset the alarm. If applicable, press the RESET key again and hold for one second to select new alarm limits. It may be necessary to start the blood pump at a slower speed and gradually work up to the prescribed rate. If unable to reset alarm, return blood to the patient if possible. Do not return clotted blood to the patient. 6) Take the machine out of service and alert a qualified service technician.

Message	Purpose of Message	Type	Action Required
Base Na+ greater than max. value	Entered Base Na+ is higher than allowed.	Dialog Message	The Base Na+ will be set to the highest allowed Na+ level. Press CONFIRM to clear message and accept the maximum allowed value. Verify that the value is acceptable or enter new value.
Base Na+ has been set to min.	The operator has attempted to set a Base Na+ lower than allowed.	Dialog Message	The Base Na+ will be set to the lowest allowed Na+ level. Confirm if value is acceptable or enter new value.
Bic Pump Alarm	This is a pump failure warning.	Warning	A single occurrence is not a problem if the machine automatically resets. If the problem persists for longer than one minute or occurs repeatedly, turn machine power off and back on. If alarm is not cleared, return the blood to the patient if alarm occurs during treatment. Take the machine out of service.
Bic Pump Always EOS	This is a pump failure warning.	Warning	A single occurrence is not a problem if the machine automatically resets. If the problem persists for longer than one minute or occurs repeatedly, turn machine power off and back on. If alarm is not cleared, return the blood to the patient if alarm occurs during treatment. Take the machine out of service.
Bic Pump No EOS	This is a pump failure warning.	Warning	A single occurrence is not a problem if the machine automatically resets. If the problem persists for longer than one minute or occurs repeatedly, turn machine power off and back on. If alarm is not cleared, return the blood to the patient if alarm occurs during treatment. Take the machine out of service.
Bic Conn Out of Port	The blue bicarbonate wand/connector is out of its port.	Warning	Connect blue (bicarbonate) wand/connectors into the blue rinse port. Verify the concentrate selection.
Bicarbonate greater than max. value	Entered Bicarbonate level is higher than allowed.	Dialog Message	The Bicarbonate will be set to the highest allowed bicarbonate level. Press CONFIRM to clear message and accept the maximum allowed value. Verify that the value is acceptable or enter new value.
Bicarbonate has been set to min.	The operator has attempted to set a Bicarbonate level lower than allowed.	Dialog Message	The Bicarbonate will be set to the lowest allowed bicarbonate level. Confirm if value is acceptable or enter new value.
Blood flow unstable	When attempting to start an OLC test, certain conditions are necessary, including stable blood flow rate.	Advisory	Wait a minute or so and start the OLC test again.
Blood Leak not Calib	The blood leak detector is not in calibration.	Alarm	Return the blood to the patient if alarm occurs during treatment. Take the machine out of service and alert a qualified service technician.

Blood Leak?	The blood leak detector has detected the presence of blood or air in the dialysate.	Blood Alarm	<p>1) Press RESET to reset the alarm. If allowed by facility policy, press Override to continue dialysis if the machine cannot be reset.</p> <p>2) Check dialysate fluid for presence of blood with a blood leak test strip.</p> <p>If test is negative, recheck with a new blood leak test strip. If negative after three checks, follow steps below:</p> <p>Press Override to run the blood pump for up to 3 minutes while troubleshooting the alarm.</p> <p>Check the dialyzer supply and return lines for air leaks, especially at the dialyzer connectors and the filter screen in the dialyzer return line. Press RESET to reset alarm.</p> <p>If unable to reset the alarm, return the patient's blood according to procedure below (test positive) and alert a qualified service technician.</p> <p>If test is positive, proceed according to facility blood leak policy. If facility policy is to return patient's blood, follow the steps below:</p> <p>1) Press RESET to reset all other blood flow alarms.</p> <p>2) Press Override to enable the blood pump to run and return patient's blood per unit protocol.</p>
	<p> Note: Air or disinfectants containing peracetic acid may cause a false alarm.</p> <p> Warning! During an override, the machine's blood leak detector is inactive. You must monitor the treatment.</p>		
Blood Pump +5 V Error	+ 5 volts is outside the allowable range	Alarm	See message E.10
Blood Pump +12 V Error	+ 12 volts is outside the allowable range	Alarm	See message E.07
Blood Pump -12 V Error	- 12 volts is outside the allowable range	Alarm	See message E.09
Blood Pump +24 V Error	+ 24 volts is outside the allowable range	Alarm	See message E.08

Message	Purpose of Message	Type	Action Required
Blood Pump Button Alarm	Key stuck or held in too long	Alarm	See message A.16
Blood Pump Direction Error	Pump is turning in the wrong direction	Alarm	See message A.13
Blood Pump Calib Alarm	Pressure was adjusted too much in calibration mode	Alarm	See message A.26
Blood Pump EEPROM Err	EEPROM error	Alarm	See message E.05
Blood Pump EPROM Error	EPROM CRC error	Alarm	See message E.01
Blood Pump Erasing Error	Error erasing Flash ROM while in Service Mode	Alarm	See message E.98
Blood Pump Failure	Electronic self-test failure.	Alarm	Turn machine power off and back on. If alarm does not clear, return the blood to the patient if alarm occurs during treatment. Take the machine out of service and alert a qualified service technician.
Blood Pump Flash Error	Error copying data into Flash ROM while in Service Mode	Alarm	See message E.97
Blood Pump RAM Error	RAM check error	Alarm	See message E.03
Blood Pump Rate Alarm	Pump is not reaching speed at maximum voltage	Alarm	See message A.11
Blood Pump ROM Error	Flash ROM CRC error	Alarm	See message E.02
Blood Pump Stop Alarm	Pump rotor turning when it should not be	Alarm	See message A.29

Blood Pump Stopped	The blood pump is on and the speed is set, but the blood pump has stopped for a period exceeding its set time limit of either 15 or 30 seconds (time limit is set with dip switch #4 on the blood pump module PCB).	Blood Alarm	<ol style="list-style-type: none"> 1) Correct other blood alarms that could have triggered the stopped pump message. 2) Inspect the blood pump module to see if: <ul style="list-style-type: none"> • The blood pump door is closed. • The pump tube segment is properly positioned. Correct if necessary. 3) Press the RESET key to reset the alarm. 4) If running double-needle dialysis with the single needle pump in the machine, the Single Needle option in the “Tests & Options” screen must be off. 5) If running single-needle dialysis with the single needle pump in the machine, the Single Needle option in the “Tests & Options” screen must be on. Next, <ul style="list-style-type: none"> • Set blood flow rate to zero • Increase the blood pump rate to 100 ml/min • Check the pillow on the arterial bloodline below the arterial blood pump for poor blood flow. 6) Slowly increase flow to the prescribed rate. If unable to resume blood flow rate, manually return the blood to the patient if alarm occurs during treatment. Take the machine out of service and alert a qualified service technician to replace the blood pump module.
Blood Pump Tach Alarm	Optical tachometer not in range	Alarm	See message A.24
Blood Pump Task Error	Software task was not completed correctly	Alarm	See message E.15
Blood Pump Timer Error	50 ms second time period exceeded	Alarm	See message E.14
Blood Pump Update Error	Transmit error during Flash update while in Service Mode	Alarm	See message E.99
Blood Pump Volt Error	Reference Voltage error	Alarm	See message E.04
Blood Pump WD Error	Watchdog timeout	Alarm	See message E.06

Message	Purpose of Message	Type	Action Required
Blood Sensed	An action has been initiated that requires that blood not be sensed.	Warning	<ol style="list-style-type: none"> 1) Inspect the optical detector below the line clamp. 2) Press RESET to reset the alarm. 3) If the alarm is not cleared, return the blood to the patient if alarm occurs during treatment. Take the machine out of service and alert a qualified service technician.
Blood Still Sensed!	Blood is sensed by the optical detector while in the opening screen and with the red wand is put in the port on the front of the machine.	Warning	<ol style="list-style-type: none"> 1) Verify that there is no longer blood in the venous return line 2) Inspect the optical detector below the line clamp. 3) Reset the alarm. 4) If the alarm is not cleared, take the machine out of service and alert a qualified service technician.
BP Comm. Timeout	Time out when receiving Intel-Hex-line or overflowed received buffer	Alarm	See message A.27
BP Del. Rate Alarm	Actual speed-read back analog voltage at X348/10 is out of limits	Alarm	See message A.21
BP Direction Alarm	Pump is turning in the wrong direction	Alarm	See message A.13
BP Feedback Alarm	Arterial rate and the blood pump's arterial setting knob do not track in sync.	Alarm	If the warning is not cleared, return the blood to the patient if alarm occurs during treatment. Take the machine out of service and alert a qualified service technician.
BP Level Up Alarm	Pressure increase when the Level Up key is pressed	Alarm	See message A.25
BP Pressure Alarm	Arterial pressure-read back analog voltage at X348/7 is out of limits SN pressure-read back analog voltage is out of limits	Alarm	See message A.22
BP Receive Alarm	Error in received Intel-Hex-line	Alarm	See message A.28
BP Rotation Error	Pump rotor turning when it should not be for a second time	Alarm	See message E.23
BP Set Rate Alarm	Set speed-read back analog voltage at X348/14 is out of limits	Alarm	See message A.20

BPM: Cuff Press High	Blood pressure cuff is above 300 mmHg for standard patients or above 220 mmHg for Low Volume patients.	Blood Pressure Alarm	Press the Stat/Deflate key to deflate the cuff. Observe the patient for physiologic changes. Indicates a hardware malfunction. If problem persists, remove cuff and alert a qualified service technician.
BPM: Cuff Press Low	Blood pressure cuff is below 10 mmHg.	Blood Pressure Alarm	Check for loose connection in the inflation system. Indicates a hardware malfunction. If problem persists, remove cuff and alert a qualified service technician.
BPM: Diastolic High	The diastolic blood pressure reading is above the set Upper Diastolic alarm limit.	Blood Pressure Alarm	Observe the patient for physiologic changes. Treat patient as symptoms warrant.
BPM: Diastolic Low	The diastolic blood pressure reading is below the set Lower Diastolic alarm limit.	Blood Pressure Alarm	Observe the patient for physiologic changes. Treat patient as symptoms warrant.
BPM: Measure > 90 sec	The blood pressure test has been in progress for more than 90 seconds.	Blood Pressure Alarm	Press Stat/Deflate key to deflate the pressure cuff. Check the patient for signs for physiologic changes. Indicates a hardware malfunction. If problem persists, remove cuff and alert a qualified service technician.
BPM: Motion Detected	Movement of the patient, cuff tubing, or some other pressure on the detection system.	Blood Pressure Alarm	Observe the patient for physiologic changes. Treat patient as symptoms warrant.
BPM: Not Communicating	Blood pressure module is not communicating with the machine	Blood Pressure Alarm	If problem persists, alert a qualified service technician.
BPM: Not Deflating	Obstruction in inflation system or valve in blood pressure module malfunction.	Blood Pressure Alarm	1) Remove kink in line to cuff. 2) May indicate a hardware malfunction. If problem persists, remove cuff and alert a qualified service technician.
BPM: Oscil Wave Check	The diastolic blood pressure reading is close to or greater than the systolic pressure reading.	Blood Pressure Alarm	Indicates a hardware malfunction. If problem persists, remove cuff and alert a qualified service technician.
BPM: Pulse > 100	Patient's heart rate is above 100 beats per minute.	Blood Pressure Alarm	Observe the patient for physiologic changes. Treat patient as symptoms warrant. May also indicates a hardware malfunction.

Message	Purpose of Message	Type	Action Required
BPM: Pulse Amp Unif	The amplitude of the pressure pulses is inconsistent with an accurate blood pressure profile.	Blood Pressure Alarm	Check pressure cuff for proper fit and alignment. Observe the patient for physiologic changes. Treat as patient as symptoms warrant.
BPM: Pulse High	The latest pulse reading is above the Upper Pulse alarm limit.	Blood Pressure Alarm	Observe the patient for physiologic changes. Treat patient as symptoms warrant.
BPM: Pulse Low	The latest pulse reading is below the Lower Pulse alarm limit.	Blood Pressure Alarm	Observe the patient for physiologic changes. Treat patient as symptoms warrant.
BPM: Pump On > 30 sec	The pump that inflates the cuff has been running longer than 30 seconds for a standard patient or longer than 10 seconds for a Low Volume patient.	Blood Pressure Alarm	Cuff is not inflating. Check for loose tubing connections or a leak in the cuff.
BPM: Systolic High	The systolic blood pressure reading is above the set Upper Systolic alarm limit.	Blood Pressure Alarm	Observe the patient for physiologic changes. Treat patient as symptoms warrant.
BPM: Systolic Low	The systolic blood pressure reading is below the set Lower Systolic alarm limit.	Blood Pressure Alarm	Observe the patient for physiologic changes. Treat patient as symptoms warrant.
BPM: Weak Pulse	The pulse pressure is too weak to register an accurate measurement.	Blood Pressure Alarm	Check the cuff for proper fit and inflation. Observe the patient for physiologic changes. Treat patient as symptoms warrant.
BPM: Zero Pressure	No pressure is detected by the blood pressure module.	Blood Pressure Alarm	Check for a loose connection in the inflation system. Correct as necessary. If no leak found, turn the power off, then back on. If problem persists, alert a qualified service technician.
BTM test underway	The OLC test may not be started when a BTM recirculation test is underway.	Advisory	Wait for the BTM recirculation test to complete before beginning the OLC test
BVM Failed	The BVM module has failed	Alarm	Press RESET to clear the message. BVM will no longer pass information to the 2008K ² monitor. Turn the power off and back on. If the alarm is not cleared, refer to a qualified service technician.

BVM No Communication	The BVM module has lost communication with the 2008K ² system.	Alarm	Press RESET to clear the message. BVM will no longer pass information to the 2008K ² monitor until power has been turned off and back on. If alarm is not cleared, return the blood to the patient if alarm occurs during treatment. Take the machine out of service and alert a qualified service technician.
Chem not Connected?	The red acid connector is still connected to the red rinse port	Warning	Connect the red (acid) connector into its correct configuration for the operation selected.
Concentrate Connected?	The red acid connector is not connected to the concentrate container.	Warning	Connect the red (acid) connector to the acid supply.
Cond Offset Failure	Electronic self-test failure.	Alarm	Turn machine power Off and back On. If alarm is not cleared, take the machine out of service and alert a qualified service technician.
Cond Ref Failure	Electronic self-test failure.	Alarm	Turn machine power Off and back On. If alarm is not cleared, take the machine out of service and alert a qualified service technician.
Conductivity High	The actual or measured conductivity has exceeded the high conductivity alarm limit. The machine is in bypass mode.	Dialysate Alarm	1) Check for the prescribed baseline Na ⁺ and Bicarbonate values on the "Dialysate" screen and re-enter the correct value for any erroneous values.
			 Note: The SVS must be off before attempting to adjust any parameter on this screen.
			2) Check that the concentrates are properly mixed and in their proper containers. Remix concentrates as needed. 3) Allow five minutes for conductivity to reach the prescribed level and adjust the conductivity alarm limit window if necessary (see "Conductivity Limits" on page 69). 4) Verify that there is flow out of the drain. 5) Replace the concentrates if it appears that the fluid is being pulled in, but the conductivity is still high. After the prescribed conductivity is reached, verify the conductivity and the pH using independent testing devices. If unable to attain prescribed conductivity, discontinue treatment and alert a qualified service technician.

Message	Purpose of Message	Type	Action Required
Conductivity Limits set to default	Conductivity limits were found to be outside of the allowed range at power up.	Opening Screen	After entering Dialysis, verify that the conductivity limits are as desired.
Conductivity Low	The actual or measured conductivity has exceeded the low conductivity alarm limit. The machine is in bypass mode.	Dialysate Alarm	<p>1) Check to see if :</p> <ul style="list-style-type: none"> • Dialysate flow is on. • The correct concentrate is selected in the "Dialysate" screen and the concentrate supply lines are connected to appropriate concentrate sources. • The prescribed concentrate and the correct baseline Na⁺ and Bicarbonate values are displayed in the "Dialysate" screen. • The supply of concentrate is adequate. • The concentrate has been mixed properly, (i.e. bicarbonate mixed well with RO water). <p>2) Verify that the concentrate connectors are sucking concentrate. If not:</p> <ul style="list-style-type: none"> • Turn off dialysate flow and disconnect the concentrate suction connectors from their wands. • Check for clogged filter screens in the connector handles, especially the bicarbonate connector. Clean if necessary. Re-assemble the concentrate connectors. Verify that the connectors and filter assemblies are tightly screwed together with no air leak. • Check that the O rings on the tips of the concentrate connectors are not damaged or missing. • Reconnect the connector to the concentrate source. Turn on dialysate flow and recheck the connectors for suction. If suction is present, allow 5 minutes for conductivity to reach the prescribed level. <p>If suction is not present in both connectors, discontinue treatment and remove patient from the machine. Perform an Acid Clean program followed by a complete rinse cycle. Test machine operation. If conductivity alarm persists, take the machine out of service and alert a qualified service technician.</p>

Conductivity out of range	When attempting to start an OLC test, certain conditions are necessary, including the condition that conductivity for both the inlet and outlet sensors be in range	Advisory	Wait until the conductivity is stable and start the OLC test again. If the message repeats, do not use OLC until the conductivity sensors have been recalibrated.
CONFIRM Concentrate	This message will be displayed if the user needs to confirm the concentrate selected for use	Advisory	Press CONFIRM or change the concentrate selection and then press CONFIRM .
Connector(s) Out Of Port	An action has been initiated that requires the Acid/Bicarbonate Connectors to be in their rinse ports	Warning	Insert the concentrate connectors into their proper rinse ports.
Cooling Down	The machine is cooling down from a heat disinfect.	Advisory	Advisory message only. No action is required.
** Cover is Open **	The dialysate shunt door is open.	Advisory	To proceed with the selected operation, close the shunt door.
Cuff Pressure = XXX	This is displayed during the blood pressure measurement. The cuff pressure is XXX mmHg.	Dialog Message	No action is necessary.
Dial Valve Failure 1	Electronic self-test failure.	Alarm	Turn machine power off and back on. If alarm does not clear, return the blood to the patient if alarm occurs during treatment. Take the machine out of service and alert a qualified service technician.
Dial Valve Failure 2	Electronic self-test failure.	Alarm	Turn machine power off and back on. If alarm does not clear, return the blood to the patient if alarm occurs during treatment. Take the machine out of service and alert a qualified service technician.

Message	Purpose of Message	Type	Action Required
Dialysate flow is off	Dialysate flow is necessary to run an OLC test.	Advisory	Do not attempt to run an OLC test unless the dialysate flow is set between 300 – 800 ml/min.
Dialysate flow unstable	When attempting to start an OLC test, certain conditions are necessary, including stable dialysate flow rate.	Advisory	Wait a minute or so and start the OLC test again.
Dialysis	Machine is currently in Dialysis Mode.	Advisory	Advisory message only. No action is required.
Dialysis Paused	In Dialysis Mode, Tx clock is paused.	Advisory	Status line advisory message only. No action is required.
Dialyzer Connected?	Indicates that one of the following conditions exist: <ul style="list-style-type: none"> • Test button selected but the dialyzer supply and return lines are not in the shunt. • Dialyzer supply and return lines are on the shunt but blood is sensed and the blood flow is on. 	Advisory	To proceed, either: Connect the dialyzer supply and return lines to the shunt if the procedure requires them to be connected at this time. Or, Connect the dialyzer supply and return lines to the dialyzer if the procedure requires them to be connected at this time.  Note: This message may also briefly appear if the blood pump rate is set too low during setup. Raise the rate to at least 100 ml/min when the blood pump is running.
Diasafe Test Failed	This message advises the operator of the status of the Diasafe self test	Warning	Press the RESET key to clear the message. Rerun the test. If test fails again return the blood to the patient if alarm occurs during treatment. Take the machine out of service and alert a qualified service technician to replace the Diasafe filter if necessary
Diasafe Test Passed	This message advises the operator of the status of the Diasafe self test	Advisory	Press the RESET key to clear the message
Diasafe Test Recovery	This message advises the operator of the status of the Diasafe self test.	Advisory	Advisory message only. No action is required.
E.01 (Arterial or SN Blood Pump Message)	EPROM CRC error	Alarm	If this message occurs in Dialysis Mode, return the blood to the patient if during a treatment. Take the blood pump module out of service and alert a qualified service technician.
E.02 (Arterial or SN Blood Pump Message)	Flash ROM CRC error	Alarm	If this message occurs in Dialysis Mode, return the blood to the patient if during a treatment. Take the blood pump module out of service and alert a qualified service technician.
E.03 (Arterial or SN Blood Pump Message)	RAM check error	Alarm	If this message occurs in Dialysis Mode, return the blood to the patient if during a treatment. Take the blood pump module out of service and alert a qualified service technician.

E.04 (Arterial or SN Blood Pump Message)	Reference Voltage error	Alarm	If this message occurs in Dialysis Mode, return the blood to the patient if during a treatment. Take the blood pump module out of service and alert a qualified service technician.
E.05 (Arterial or SN Blood Pump Message)	EEPROM error	Alarm	If this message occurs in Dialysis Mode, return the blood to the patient if during a treatment. Take the blood pump module out of service and alert a qualified service technician.
E.06 (Arterial or SN Blood Pump Message)	Watchdog timeout	Alarm	If this message occurs in Dialysis Mode, return the blood to the patient if during a treatment. Take the blood pump module out of service and alert a qualified service technician.
E.07 (Arterial or SN Blood Pump Message)	+ 12 volts is outside the allowable range	Alarm	If this message occurs in Dialysis Mode, return the blood to the patient if during a treatment. Take the blood pump module out of service and alert a qualified service technician.
E.08 (Arterial or SN Blood Pump Message)	+ 24 volts is outside the allowable range	Alarm	If this message occurs in Dialysis Mode, return the blood to the patient if during a treatment. Take the blood pump module out of service and alert a qualified service technician.
E.09 (Arterial or SN Blood Pump Message)	- 12 volts is outside the allowable range	Alarm	If this message occurs in Dialysis Mode, return the blood to the patient if during a treatment. Take the blood pump module out of service and alert a qualified service technician.
E.10 (Arterial or SN Blood Pump Message)	+ 5 volts is outside the allowable range	Alarm	If this message occurs in Dialysis Mode, return the blood to the patient if during a treatment. Take the blood pump module out of service and alert a qualified service technician.
E.14 (Arterial or SN Blood Pump Message)	50 ms second time period exceeded	Alarm	If this message occurs in Dialysis Mode, return the blood to the patient if during a treatment. Take the blood pump module out of service and alert a qualified service technician.
E.15 (Arterial or SN Blood Pump Message)	Software task was not completed correctly	Alarm	If this message occurs in Dialysis Mode, return the blood to the patient if during a treatment. Take the blood pump module out of service and alert a qualified service technician.
E.23 (Arterial or SN Blood Pump Message)	Pump rotor turning when it should not be for a second time	Alarm	If this message occurs in Dialysis Mode, return the blood to the patient if during a treatment. Take the blood pump module out of service and alert a qualified service technician.
E.97 (Arterial or SN Blood Pump Message)	Error copying data into Flash ROM while in Service Mode	Alarm	If this message occurs in Dialysis Mode, return the blood to the patient if during a treatment. Take the blood pump module out of service and alert a qualified service technician.
E.98 (Arterial or SN Blood Pump Message)	Error erasing Flash ROM while in Service Mode	Alarm	If this message occurs in Dialysis Mode, return the blood to the patient if during a treatment. Take the blood pump module out of service and alert a qualified service technician.

Message	Purpose of Message	Type	Action Required
E.99 (Arterial or SN Blood Pump Message)	Transmit error during Flash update while in Service Mode	Alarm	If this message occurs in Dialysis Mode, return the blood to the patient if during a treatment. Take the blood pump module out of service and alert a qualified service technician.
EEPROM already used, Power Off, Replace EEPROM	Advisory message when uploading hardware key option	Advisory	Put in a new hardware key or calibration EEPROM in IC 20 and power up.
EEPROM Missing or Reading Error	During startup, the machine cannot properly read the EEPROM memory chip	Opening Screen Message	Turn the machine off and try to power up again. If the message repeats, take the machine out of service and alert a qualified service technician.
Emptying	The blue dialysate line connector is on the shunt with door closed, the red dialysate line connector remains on the dialyzer in order to drain the dialysate compartment.	Warning	If this message occurs when the dialyzer is not being emptied, take the machine out of service and alert a qualified service technician.
Emptying Stopped	When air is sensed, emptying will stop.	Warning	Connect the red dialyzer return line to the shunt. If the warning is repeated, take the machine out of service and alert a qualified service technician.
Emptying too long	The dialyzer empty program has exceeded its maximum limit.	Alarm	If blood is not sensed, return the dialyzer supply and return lines to the shunt and close the shunt door to terminate the program. If the machine was in dialysis (blood sensed), turn machine power off and back on to clear the program.
Error Reading Flash	Electronic Self Test	Alarm	Turn machine power off and back on. If alarm is not cleared, take the machine out of service and alert a qualified service technician.
Fail * 9 Volt Battery	9V Power Failure Battery test has failed.	Test Message	Replace Battery
Fail * Actuator Arterial High Fail * Actuator Arterial Low	Arterial Pressure test has failed.	Test Message	Rerun test, if failure repeats, remove machine from service and alert a qualified service technician.
Fail * Actuator Conductivity High Fail * Actuator Conductivity Low	Conductivity test has failed.	Test Message	Rerun test, if failure repeats, remove machine from service and alert a qualified service technician.



Fail * Actuator Temperature High Fail * Actuator Temperature Low	Temperature test has failed.	Test Message	Verify stable temp. Rerun test. If failure repeats, remove machine from service and alert a qualified service technician to recalibrate if failure repeats
Fail * Actuator TMP High Fail * Actuator TMP Low	Transmembrane Pressure (TMP) test has failed.	Test Message	Rerun test. If failure repeats, remove machine from service and alert a qualified service technician.
Fail * Actuator Venous High Fail * Actuator Venous Low	Venous Pressure test has failed.	Test Message	Rerun test, if failure repeats, remove machine from service and alert a qualified service technician.
Fail * Air Detector	Air detector test has failed.	Test Message	Reposition venous drip chamber. Rerun Test. If failure repeats, remove machine from service and alert a qualified service technician.
Fail * Arterial High Soft Fail * Arterial Low Soft Fail * Arterial High Hard Fail * Arterial Low Hard	Arterial Pressure test has failed.	Test Message	Rerun test, if failure repeats, remove machine from service and alert a qualified service technician.
Fail * Blood Leak 1 Fail * Blood Leak 2	Blood Leak test has failed.	Test Message	Verify absence of air bubbles in flow indicator. Rerun test. If failure repeats, remove machine from service and alert a qualified service technician.
Fail * Cond High Soft Fail * Cond Low Soft	Conductivity test has failed.	Test Message	Rerun test, if failure repeats, remove machine from service and alert a qualified service technician.
Fail * (Get Neg TMP)	Get Neg TMP test has failed.	Test Message	Check UF pump. Rerun test. If failure repeats, remove machine from service and alert a qualified service technician.
Fail * (Get Pos TMP)	Get Pos TMP test has failed.	Test Message	Rerun test. If failure repeats, remove machine from service and alert a qualified service technician.

Message	Purpose of Message	Type	Action Required
Fail * Neg Flow On	Negative flow on pressure holding test failed	Test Message	Rerun test. If failure repeats, remove machine from service and alert a qualified service technician.
Fail * Neg Stabilize	Negative flow stabilize test failed.	Test Message	Rerun test. If failure repeats, remove machine from service and alert a qualified service technician.
Fail * Optical Detect	Optical Detector test has failed.	Test Message	Rerun test, if failure repeats, remove machine from service and alert a qualified service technician.
Fail * Pos Flow Off	Positive flow off pressure holding test failed	Test Message	Rerun test. If failure repeats, remove machine from service and alert a qualified service technician.
Fail * Pos Stabilize	Positive flow stabilize test failed.	Test Message	Rerun test. If failure repeats, remove machine from service and alert a qualified service technician.
Fail * (Remove Air)	Remove air test failed.	Test Message	Rerun test. If failure repeats, remove machine from service and alert a qualified service technician.
Failed Sending Data to Actuator Board	Functional to Actuator board communication problem during startup.	Alarm	Turn machine power off and back on. If alarm is not cleared, take the machine out of service and alert a qualified service technician.
Fail * Temp High Soft Fail * Temp Low Soft	Temperature test has failed.	Test Message	Verify stable temp. Rerun test. If failure repeats, remove machine from service and alert a qualified service technician to recalibrate.
Fail * Temp High Hard Fail * Temp Low Hard	Temperature test has failed.	Test Message	Verify stable temp. Rerun test. If failure repeats, remove machine from service and alert a qualified service technician to recalibrate.
Fail * TMP High Soft Fail * TMP Low Soft Fail * TMP High Hard Fail * TMP Low Hard	Transmembrane Pressure (TMP) test has failed.	Test Message	Rerun test. If failure repeats, remove machine from service and alert a qualified service technician.

Fail * Ven High Soft Fail * Ven Low Soft Fail * Ven High Hard Fail * Ven Low Hard	Venous Pressure test has failed.	Test Message	Rerun test, if failure repeats, remove machine from service and alert a qualified service technician.
** Failed Sending Data to Actuator Board **	Functional to Actuator board communication problem during startup.	Alarm	Turn machine power off and back on. If alarm is not cleared, take the machine out of service and alert a qualified service technician.
Fill for Diasafe Test	This message indicates the status of the Diasafe test	Advisory	Advisory only. No action is required.
Fill Program Alarm	A Fill program has occurred for one minute while blood is sensed.	Alarm	Inspect for air in the system. Correct as required. If the warning is not cleared, return the blood to the patient if alarm occurs during treatment. Take the machine out of service and alert a qualified service technician.
Filling Program	A Fill program is in progress.	Advisory	Advisory only. No action is required.
Flow Error	General Flow Alarm	Warning	A single occurrence is not a problem if the machine automatically resets. If the problem persists for longer than one minute or occurs repeatedly: 1) Check the water supply flow to the machine. 2) Check that the Dialysate Flow is on. 3) Check the dialyzer supply and return lines for kinks. 4) Set Dialysate Flow in the "Home" screen to 500 ml/min and verify that the flow from the drain line is 500 ml/min \pm 50 ml/min. 5) Turn the power off and on. If warning is not cleared, return the blood to the patient if alarm occurs during treatment. 6) Take the machine out of service and alert a qualified service technician.

Message	Purpose of Message	Type	Action Required
Flow Inlet Error	Float Switch	Warning	<p>A single occurrence is not a problem if the machine automatically resets. If the problem persists for longer than one minute or occurs repeatedly:</p> <ol style="list-style-type: none"> 1) Check the water supply flow to the machine. 2) Check that the Dialysate Flow is on. 3) Set Dialysate Flow in the "Home" screen to 500 ml/min and verify that the flow from the drain line is 500 ml/min \pm 50 ml/min. 4) Turn the power off and on. If warning is not cleared, return the blood to the patient if alarm occurs during treatment. 5) Take the machine out of service and alert a qualified service technician.
Flow is Off	Dialysate flow is off.	Warning	An action has been initiated that requires the dialysate flow to be on. To proceed with the selected operation, turn the dialysate flow on.
Flow is still On	Dialysate flow is on.	Warning	An action has been initiated that requires the dialysate flow to be off. To proceed with the selected operation, first turn the dialysate flow off.
Flow Rate not Set	If the dialysate flow is turned on while the flow rate selection is still "SEQ", this reminder is displayed	Advisory	Set the dialysate flow rate to the desired value.
Flow Recirc Error 1	Dialysate flow problem.	Warning	<p>A single occurrence is not a problem if the machine automatically resets. If the problem persists for longer than one minute or occurs repeatedly:</p> <ol style="list-style-type: none"> 1) Check the water supply flow to the machine. 2) Check that the Dialysate Flow is on. 3) Set Dialysate Flow in the "Home" screen to 500 ml/min and verify that the flow from the drain line is 500 ml/min \pm 50 ml/min. 4) Turn the power off and on. If warning is not cleared, return the blood to the patient if alarm occurs during treatment. 5) Take the machine out of service and alert a qualified service technician.



Flow Recirc Error 2	Dialysate flow problem.	Warning	<p>A single occurrence is not a problem if the machine automatically resets. If the problem persists for longer than one minute or occurs repeatedly:</p> <ol style="list-style-type: none"> 1) Check the water supply flow to the machine. 2) Check that the Dialysate Flow is on. 3) Set Dialysate Flow in the “Home” screen to 500 ml/min and verify that the flow from the drain line is 500 ml/min ± 50 ml/min. 4) Turn the power off and on. If warning is not cleared, return the blood to the patient if alarm occurs during treatment. 5) Take the machine out of service and alert a qualified service technician.
Front Panel No Comm	The processor is unable to communicate with the front panel	Opening Screen Message	Turn machine power off and back on. If failure repeats, return the blood to the patient if alarm occurs during treatment. Take the machine out of service and refer to a qualified service technician.
Greater than max. value	Entered parameter is larger than allowed	Dialog Message	Verify that the maximum value is acceptable. Press CONFIRM to clear message and accept the maximum allowed value.
Heat Relay Test Fail	Electronic self-test failure.	Alarm	Turn machine power off and back on. If alarm is not cleared, take the machine out of service and alert a qualified service technician.
Heparin Dwell Complete	The five minute timer for a manual heparin bolus has elapsed.	Advisory	Press the RESET key to clear the message. The Status Light will stop flashing.
Heparin Pump Alarm	The Heparin pump is encountering resistance.	Alarm	<ol style="list-style-type: none"> 1) Check the heparin line for clamps or kinks and correct. 2) Check the heparin syringe for adequate amount of heparin and correct. 3) Ensure the correct type of syringe is loaded and locked in place properly. 4) Press RESET to clear the alarm and restart the heparin pump. 5) If the alarm will not reset or continues to alarm intermittently, return the blood to the patient if alarm occurs during treatment. 6) Take the heparin pump out of service and alert a qualified service technician.
	 <p>Note: An alarm will sound when the heparin pump has reached the end of its stroke during normal operation.</p>		

Message	Purpose of Message	Type	Action Required
High Flow Error	Possible balancing chamber problem.	Warning	<p>A single occurrence is not a problem if the machine automatically resets. If the problem persists for longer than one minute or occurs repeatedly:</p> <ol style="list-style-type: none"> 1) Check the water supply flow to the machine. 2) Check that the Dialysate Flow is on. 3) Set Dialysate Flow in the “Home” screen to 500 ml/min and verify that the flow from the drain line is 500 ml/min ± 50 ml/min. 4) Turn the power off and on. If warning is not cleared, return the blood to the patient if alarm occurs during treatment. 5) Take the machine out of service and alert a qualified service technician.
High Temperature	<p>The actual dialysate temperature has exceeded the high-temperature alarm limit. Machine is in bypass mode.</p> <div style="border: 1px solid black; padding: 5px; margin-top: 10px;">  <p>Note: If the temperature fluctuates between HIGH TEMPERATURE and LOW TEMPERATURE, see “VARIABLE TEMPERATURE.”</p> </div>	Dialysate Alarm	<ol style="list-style-type: none"> 1) Ensure that water is flowing to machine when turned on. 2) Check water supply to machine for excess temperature and correct if necessary. 3) If heat disinfection was recently performed, place machine in rinse cycle to decrease temperature. 4) Check the Temperature value in the “Home” screen. Re-enter it if necessary and allow five minutes for the temperature to stabilize. 5) Check that the dialysate flow at drain line is 500 ml/min ± 50 ml. 6) If unable to reach prescribed temperature, return the blood to the patient if alarm occurs during treatment. 7) Take the machine out of service, discontinue treatment, and alert a qualified service technician.
 <p>Warning! Hemolysis of blood in the dialyzer may occur should the dialysate exceed a temperature of 42 °C. Dialysate temperatures <u>must</u> be maintained below this level. Do not return hemolyzed blood to the patient.</p>		 <p>Caution: Do not use the Heat Disinfect cycle until the machine has been repaired. If you are unable to attain proper dialysate temperature, return the blood to the patient if alarm occurs during treatment. Take the machine out of service and alert a qualified service technician.</p>	

Hold CONFIRM to Prime	In heparin screen after selecting prime must press and hold confirm to prime heparin line.	Dialog Message	Press and hold CONFIRM to prime the heparin line.
I2C Read Time Out I2C Bus Read Error I2C Bus Read Too Long I2C Byte Write Error	Functional to I2C EEPROM communication problem.	Alarm	Turn machine power off and back on. If alarm is not cleared, return the blood to the patient if alarm occurs during treatment. Take the machine out of service and alert a qualified service technician.
In bypass for 8 min	Press RESET to clear the message	Advisory	The machine was in bypass for about eight minutes. This may extend the time necessary to complete the treatment or rinsing of germicide. Press RESET to clear the message.  Warning! If rinsing germicide from the machine or dialyzer when this occurs, additional time will be necessary to fully rinse the germicide from the dialyzer. Always check for residual germicide using the appropriate approved residual test method.
INTERRUPT RINSE? Escape or CONFIRM	Press CONFIRM to interrupt rinse.	Dialog Message	Press CONFIRM to accept or press Escape to cancel.
Interrupted	The selected Rinse program has been interrupted.	Warning	Re-insert the dialysate connectors into the proper rinse ports. To continue the Rinse or other program, press CONFIRM , then reselect the desired program.
Invalid Data Entry for [item]	Entry value for [item] is out of range	Dialog Message	Set appropriate value for [item]
Invalid UF Rate	Entry value for goal is out of range.	Dialog Message	Readjust rate
Invalid UF Time	Entry value for goal is out of range.	Dialog Message	Readjust time

Message	Purpose of Message	Type	Action Required
Less than minimum value	Entered parameter is smaller than allowed	Dialog Message	Verify that the minimum value is acceptable. Press CONFIRM to clear message and accept the minimum allowed value.
Lost Battery RAM Data	The battery RAM memory has been lost.	Opening Screen Message	Verify all treatment settings before using the machine.
Low Acetate Warning	20% of concentrate left in acetate jug per entered value.	Warning	Check jug level, change to new jug of concentrate if needed and reenter jug volume.
Low Acid Warning	20% of concentrate left in acid jug per entered value.	Warning	Check jug level, change to new jug of concentrate if needed and reenter jug volume.
Low Acid/Bicarb Warn	20% of concentrate left in acid and bicarbonate jug per entered value.	Warning	Check jug level, change to new jug of concentrate if needed and reenter jug volume.
Low Bicarb Warning	20% of concentrate left in bicarbonate jug per entered value.	Warning	Check jug level, change to new jug of concentrate if needed and reenter jug volume.
Low Flow Error	Possible balancing chamber problem.	Warning	<p>A single occurrence is not a problem if the machine automatically resets. If the problem persists for longer than one minute or occurs repeatedly:</p> <ol style="list-style-type: none"> 1) Check the water supply flow to the machine. 2) Check that the Dialysate Flow is on. 3) Set Dialysate Flow in the "Home" screen to 500 ml/min and verify that the flow from the drain line is 500 ml/min \pm 50 ml/min. 4) Turn the power off and on. If warning does not clear, return the blood to the patient if alarm occurs during treatment. 5) Take the machine out of service and alert a qualified service technician.

Low Temperature	The actual dialysate temperature has exceeded the low-temperature alarm limit. Machine is in bypass mode.	Dialysate Alarm	<ol style="list-style-type: none"> 1) Check that the machine is in Dialysis Mode and the dialysate flow is on. 2) Check that the heater switch on the back panel is in the on () position. 3) Check the water supply to the machine for excessively cold temperature and correct. 4) Check the Temperature value in the “Home” screen. Re-enter it if necessary and allow five minutes for the temperature to stabilize. 5) If unable to attain the prescribed temperature, return the blood to the patient if alarm occurs during treatment. 6) Take the machine out of service and alert a qualified service technician.
	 Note: If the temperature fluctuates between HIGH TEMPERATURE and LOW TEMPERATURE, see “VARIABLE TEMPERATURE.”		
Low Volume Mode Set!	The ‘Low Volume’ option on the “Test & Options” screen is set to ‘On’.	Advisory	Advisory only, no action required.
Low Volume disabled: incompatible BPM!	The machine contains a blood pressure module that is incompatible with the Low Volume setting. The Low Volume setting is reset to Off and disabled.	Advisory	<p>No action required.</p> <p>If the Low Volume setting is desired, contact Fresenius Medical Care Technical Support for information on ordering alternative blood pressure modules that are compatible with Low Volume Mode.</p>
Lower Dia. has been set to Min [Max]	The operator has attempted to set the lower diastolic pressure limit higher or lower than allowed.	Dialog Message	The machine has set the limit to the highest or lowest value allowed. Verify that the limit setting is acceptable
Lower Pulse has been set to Min [Max]	The operator has attempted to set the lower pulse rate limit higher or lower than allowed.	Dialog Message	The machine has set the limit to the highest or lowest value allowed. Verify that the limit setting is acceptable
Lower Sys. has been set to Min [Max]	The operator has attempted to set the lower systolic pressure limit higher or lower than allowed.	Dialog Message	The machine has set the limit to the highest or lowest value allowed. Verify that the limit setting is acceptable
Max UF rate reached. Select new Goal or Time	This message informs the operator that the calculated UF rate is higher than the internal selection allows.	Dialog Message	In the “Home” screen, decrease the UF Goal or increase the UF Time.



Message	Purpose of Message	Type	Action Required
Max UF time reached. Select new Goal or Rate	This message informs the operator that the calculated UF time is higher than the maximum allowed.	Dialog Message	In the "Home" screen, decrease the UF Time
Max UF Removed	The UF removed amount has reached 9999 ml and the UF pump has stopped.	Warning	Follow facility protocol to stop the treatment.
Minor Blood Leak?	<p>A minor blood leak (approximately 0.35 – 0.45 ml/min) was detected in the dialysate. Air can cause a false alarm.</p> <p> Warning: During an override, the machine's blood leak detector is inactive. You must manually monitor the treatment for evidence of blood leak.</p>	Warning	<p>Press RESET to reset the alarm. Press Override to continue to run the blood pump if the alarm cannot be reset.</p> <p>Check dialysate fluid from the red dialyzer return line for presence of blood with a blood leak test strip.</p> <p>If test is negative, recheck with a new blood leak test strip. If negative after three checks, follow steps below:</p> <p>Press Override to continue to run the blood pump while troubleshooting the alarm.</p> <p>Check the dialyzer supply and dialyzer return lines for air leaks, especially at the connectors and the filter in the dialyzer return line.</p> <p>Press RESET to reset alarm.</p> <p>If unable to reset the alarm, return the patient's blood according to procedure below (test positive) and alert a qualified service technician.</p> <p>If test is positive, proceed according to the unit's blood-leak policy. If facility policy is to return patient's blood, follow the steps below.</p> <p>Press RESET to reset all other blood flow alarms.</p> <p>Press Override to enable the blood pump to run and return patient's blood per unit protocol.</p> <p> Note: Override will activate the blood pump for about three minutes while a blood leak alarm exists. Press Override again if needed.</p>
Must Be Alarm Free	A conductivity alarm exists when an SVS program attempted to start	Advisory	Correct the conductivity alarm and start the SVS program.

Must Calibrate to Run	Electronic self-test failure.	Alarm	Turn machine power off and back on. If alarm is not cleared, take the machine out of service and alert a qualified service technician.
Must Clear UF Removed	An action has been initiated that requires the UF Removed to be cleared to zero.	Warning	To proceed with the selected operation, set the UF Removed treatment button to zero.
Must Run Test First	The Forced Test is required before proceeding with UF or SVS.	Warning	To proceed with the selected operation, run the Pressure and Alarm tests. For more information, see Chapter 2 “Testing the 2008K ² Hemodialysis Machine.”
Need Blood Sensed	An action has been initiated that requires that blood is sensed.	Dialog Message	Verify venous bloodline is in the Optical Detector.
Neg. Access Flow value	This message is an advisory message that the Access Flow test result was a negative value. A positive value is expected.	Warning	This can occur if the bloodlines were initially connected in the reversed position. Press CONFIRM to clear the message. Check that the bloodlines are properly connected and repeat the Access Flow test.
Negative error AF value	This message is an advisory message that the Access Flow test result was an erroneous value	Warning	Press CONFIRM to clear the message. Check that the bloodlines are properly connected and repeat the Access Flow test. Press CONFIRM to clear the message.
New Art Limits chosen	This message advises the operator that a new set of arterial limits has been set.	Advisory	Advisory only. No action is required.
New features loaded, Power Off, Replace EEPROM	Advisory message when uploading hardware key option	Advisory	Put the original calibration EEPROM in IC 20 and restart the machine.
New TMP Limits Chosen	This message confirms that a new set of TMP limits have been set.	Advisory	Advisory only. No action is required.
New Ven Limits Chosen	New venous alarm limits are set	Advisory	Advisory only. No action is required
No 8mm in Low Volume	The Low Volume option on the “Test & Options” screen is ‘On’ and the blood pump module needs to be set for blood pump segments no larger than 6.4mm.	Alarm	Set the blood pump module for the diameter of the Low Volume pump segment by opening the blood pump door and pressing the Up (▲) and Down (▼) keys on the blood pump module simultaneously. The display will flash. Next press the Up (▲) or Down (▼) key on the blood pump module until the diameter of the pump segment being used is displayed. Close the blood pump door again. Or, if the Low Volume setting is not desired, on the “Test & Options” screen set the Low Volume toggle-button to ‘Off’.

Message	Purpose of Message	Type	Action Required
No Air Detector Alarm	The Prime key has been pressed. A level detector alarm must exist for this function to occur	Advisory	If the venous chamber has fluid detected, the prime function will not occur. Press RESET to start the blood pump. If a level detector alarm occurs, then press the Prime key.
No Chemical Intake	During the main program of chemical rinse or chemical dwell, the machine cannot get any chemical in the acid connector.	Alarm	Retry chemical rinse and if problem persist, remove machine from service and alert a qualified service technician.
No Na ⁺ Selected	This is a prompt to the operator that a Start Na ⁺ value for SVS has not been set.	Advisory	To proceed with the SVS operation, set a value for Start Na ⁺ in the "SVS" subscreen.
No Program Selected	This is a prompt to the operator that a Profile was not selected.	Advisory	To proceed with an SVS operation, select an SVS Profile from the "SVS" subscreen.
No SVS Time Selected	This is a prompt to the operator that the SVS Time has not been set.	Advisory	To proceed with the SVS operation, set the SVS Time button in the "SVS" subscreen.
No Water	A water inlet valve alarm has occurred. The machine is not receiving enough water.	Warning	Inspect the treated water source supplying the machine. Correct as required. If the alarm does not clear, return the blood to the patient if alarm occurs during treatment. Take the machine out of service and alert a qualified service technician.
OLC allowed in X minutes	There is a minimum waiting period necessary between OLC tests	Advisory	Wait the indicated time and start the OLC test again.
OLC steps not calculated	In order to do the OLC test, the machine must calculate the pump steps necessary to raise and lower the conductivity for the test. This cannot be done until stable conductivity has been achieved.	Advisory	Wait a couple of minutes after the conductivity is stable and start the OLC test again.
OLC Test Cancelled!	User has cancelled OLC self test or a condition occurred during test causing it to cancel.	Advisory	Advisory only no action required
OLC Test Failed	OLC self test failed.	Warning	Restart machine to rerun the OLC self test.
OLC Test Passed	OLC self test passed	Advisory	Advisory only no action required

Online Clearance Self-test	Machine is running an OLC self-test	Advisory	Advisory only no action required
Online Clearance Test	Machine is running an OLC measurement	Advisory	Advisory only no action required
Online PHT Failed	The online Pressure Holding Test has failed.	Warning	Reset the alarm. Check the machine for liquid leaks. If the failure message is repeated on the next test (12 minutes between tests), return the blood to the patient if alarm occurs during treatment. Take the machine out of service and alert a qualified service technician.
Online PHT Too Long	Electronic self-test failure.	Alarm	Turn machine power off and back on. If alarm is not cleared, return the blood to the patient if alarm occurs during treatment. Take the machine out of service and alert a qualified service technician.
Patient Alarm	External alarm	Alarm	Clear external alarm. If problem persist, return the blood to the patient if alarm occurs during treatment. Take the machine and alert a qualified service technician.
PHT is running	The PHT test must complete before the OLC test is allowed to run.	Advisory	Wait 15 seconds and start the OLC test again.
Plug in Venous Pump	Single Needle option was initiated but the single-needle, blood pump is not plugged into the machine port.	Warning	To proceed with the selected operation, install the single-needle blood pump into the machine.
Power Failure Recovery	The machine is powering up after a power failure. Parameters have been recovered	Opening Screen Message	Verify that all treatment settings are correct before resuming dialysis.
Press CONFIRM to exit	This message is a prompt for the operator to press the CONFIRM key to exit the Rinse program.	Advisory	To proceed with the selected operation, press CONFIRM .
Press CONFIRM to Load	This message is a prompt for the operator to press the CONFIRM key to load the heparin syringe.	Dialog Message	To proceed with the selected operation, press CONFIRM .
Press CONFIRM to Start	This message is a prompt for the operator to press the CONFIRM key to start the program.	Advisory	To proceed with the selected operation, press CONFIRM .
Press ESCAPE to cancel rinse	This message is a prompt for the operator to press the Escape key to cancel the Rinse program.	Advisory	To proceed with the selected operation, press Escape then press CONFIRM .

Message	Purpose of Message	Type	Action Required
Press ESCAPE To Stop [Item]	This message is a prompt for the operator to press the Escape key to stop loading the heparin syringe or the Rinse program.	Dialog Message	To proceed with the selected operation, press Escape then press CONFIRM .
Pressure Test Failed	The pressure test section (PHT) of the automated Test Sequence has failed.	Alarm	Reset the alarm and repeat the test. If the failure message is repeated on retest, take the machine out of service and alert a qualified service technician.
Priming	The operator has pressed the Prime key and initiated the priming function.	Advisory	Advisory only. No action is required.
Put Connectors in Port	The connectors must be in the machine ports in order to start a Rinse program	Advisory	Connect the red (acid/acetate) and/or blue (bicarbonate) connectors to the appropriate rinse ports.
Put Lines On Shunt	An action has been initiated that requires the dialyzer supply and return lines to be on the shunt.	Warning	To proceed with the selected operation, place dialyzer supply and return lines on the shunt.
Put Red Con in Chemical	This is a cleaning/disinfectant program prompt to the operator.	Advisory	Remove the red connector from the machine and place it into the wand in the yellow chemical/disinfectant bottle.
RAM Battery Failure	Electronic self-test failure.	Alarm	Turn machine power off and back on. If alarm is not cleared, take the machine out of service and alert a qualified service technician.
RAM Code Corrupted 1	Electronic self-test failure.	Alarm	Turn machine power off and back on. If alarm is not cleared, return the blood to the patient if alarm occurs during treatment. Take the machine out of service and alert a qualified service technician.
RAM Code Corrupted 2	Repeated electronic self-test failure.	Alarm	Turn machine power off and back on. If alarm is not cleared, return the blood to the patient if alarm occurs during treatment. Take the machine out of service and alert a qualified service technician.
Recirc Interrupted	The Recirculate program has been interrupted by an alarm condition.	Warning	<ol style="list-style-type: none"> 1) Inspect the blood pump condition. Correct if required. 2) Reset the alarm and turn UF back on, if applicable. 3) If the alarm does not clear, take the machine out of service and alert a qualified service technician.
Recirculating	Recirculation is in progress.	Advisory	Advisory only. No action is required.

Recirculating Done	A prompt to the operator that the recirculation process is done.	Advisory	Press RESET to clear the advisory message.
Recirculating Stopped	Recirculation has been stopped because blood is sensed or the dialyzer supply and return lines are on shunt.	Warning	Inspect the configuration of the dialyzer supply and return lines and extracorporeal blood circuit. Correct any irregularities. If the message is not cleared, take the machine out of service and alert a qualified service technician.
Recirculation in progress	Recirculation is running and the Low Volume button cannot be set to 'On'	Advisory	No action required, wait until recirculation has completed before selecting the 'Low Volume' option if desired.
Release CONFIRM to stop	This message is a prompt for the operator to release the CONFIRM key to stop priming the heparin line.	Dialog Message	Release the CONFIRM key.
Rel. Blood Volume Low	The BVM module has reported a relative blood volume below the lower limit.	Alarm	Press RESET to clear the message. Evaluate the fluid status of the patient.
RESET to adjust TMP	The TMP exceeded the hard alarm limits. The operator is given the option to relieve the pressure to bring the TMP within limits.	Warning	Press the RESET key to reset the TMP alarm limits. Press and hold the Override key to re-center the limits.
	 Warning! Adjusting the TMP repeatedly will decrease the UF removed from the patient.		 Warning! Rising TMP may indicate a leak in the balancing system and should be investigated.
Reset Treatment? CONFIRM or Escape	The New TX key has been pressed	Advisory	To reset treatment parameters for a new treatment, press the CONFIRM key. To cancel, press the Escape key.
Resetting, Try Again.	Blood pressure module resetting	Warning	Wait until blood pressure module completes resetting and retry blood pressure reading.
Retry > Press = XXX	The cuff pressure is too low to measure the blood pressure. The cuff pressure is XXX mmHg.	Dialog Message	No action necessary
Reverse bloodlines	This message is a prompt for the operator reverse the bloodlines for the Access Flow test	Warning	To proceed with the Access Flow test, reverse the bloodlines and press CONFIRM .
Rinse Cond High	The Reverse Osmosis (RO) water inlet conductivity is too high.	Opening Screen Message	Press the RESET key to clear the message. Perform a Rinse cycle. If alarm is not cleared, take the machine out of service and alert a qualified service technician.



Message	Purpose of Message	Type	Action Required
RTD = Zero	The RTD (Remaining Time on Dialysis) clock has counted down to zero.	Warning	Reset the alarm. This message has alerted the operator that the preset time on dialysis has elapsed (RTD = 0:00). If prescribed treatment time has not been completed, the operator must take further action to comply with the prescribed treatment.
Running Diasafe Test	This message is advising the operator of the status of the Diasafe test	Advisory	Advisory only. No action is required.
Running Online PHT	This message is displayed when the online Pressure Holding Test is in progress.	Advisory	Advisory only. No action is required.
Run Access Flow?	This message is a prompt for the operator begin the Access Flow test.	Warning	To proceed now, press CONFIRM . To delay, press Escape . To cancel, go to the "Kt/V AF" screen and toggle the Access Flow check box to Off.
Select Concentrate	This message is a prompt for the operator to select a concentrate.	Advisory	To select a concentrate from the menu, use the + or - (plus/minus) keys on the control panel to highlight the desired concentrate, and press CONFIRM . For more information, see Chapter 3, "Setting an Acid/Bicarbonate Type."
Select new goal or rate	UF time is out of range.	Dialog Message	Enter a new UF Goal or reduce UF time.
Select new Goal or Time	UF rate is out of range.	Dialog Message	Enter a new UF Goal or reduce UF rate.
Select Program	This message is a prompt for the operator to select a program.	Advisory	To proceed, select the desired program and press CONFIRM .
Set Arterial Limits	This is a message to re-center the arterial limits if necessary	Advisory	Press and hold Reset for 1 second to re-center the limits.
Set Blood Flow to 300	This message is a prompt for the operator to set the blood flow rate in preparation for the Access Flow test	Warning	To proceed, set Blood Flow to 300 and press CONFIRM .
Set TMP Limits?	This is a message to re-center the TMP limits if necessary	Advisory	Rising TMP may indicate a leak in the balancing system and should be investigated. Press and hold Override for 1 second to re-center the limits.

Set Venous Limits	This is a message to adjust the venous limits if necessary	Advisory	Press and hold RESET for 1 second to adjust the limits. Changes in venous pressure during the treatment should be investigated. See “Venous Pressure Alarm”
Short Power Down	The machine was switched off for 1 – 2 minutes and turned back on. Setup values have not been set to default values.	Advisory	Verify that the dialysis parameters are as desired.
Single Needle On!	An action has been initiated that requires the Single Needle option to be off.	Warning	To proceed with the selected operation, de-select the Single Needle option.
SLED Complete	The machine has reached the maximum time allowed for a SLED treatment. Ultrafiltration and dialysate flow have been turned off. The extracorporeal blood circuit must be replaced and the machine must be powered down before running another treatment.	Warning	Follow facility protocol to end the treatment.
SLED Disabled: Diasafe Filter Not Set!	SLED Mode requires that the Diasafe Filter Service Mode option is set to ‘Yes’	Advisory	To run a SLED treatment: Take the machine out of service and alert a qualified service technician before continuing. Or, if SLED Mode is not desired, select the Dialysis button to run a dialysis treatment.
SLED Paused	In SLED Mode, the Tx clock is paused.	Advisory	No action is required.
Slow Flow Uncalibrated	The temperature calibration has not been performed; SLED Mode and dialysate flow rates of 100, 150, and 200 ml/min are not available.	Advisory	To run a SLED treatment: Take the machine out of service and alert a qualified service technician before continuing. Or, if SLED Mode is not desired, select the Dialysis button to run a dialysis treatment using a dialysate flow of at least 300 ml/min.
SN BP +5 V Error	+ 5 volts is outside the allowable range	Alarm	See message E.10
SN BP +12 V Error	+ 12 volts is outside the allowable range	Alarm	See message E.07
SN BP -12 V Error	- 12 volts is outside the allowable range	Alarm	See message E.09

Message	Purpose of Message	Type	Action Required
SN BP +24 V Error	+ 24 volts is outside the allowable range	Alarm	See message E.08
SN BP Button Alarm	Key stuck or held in too long	Alarm	See message A.16
SN BP Comm. Timeout	Time out when receiving Intel-Hex-line or overflowed received buffer	Alarm	See message A.27
SN BP Del. Rate Alarm	Actual speed-read back analog voltage at X348/10 is out of limits	Alarm	See message A.21
SN BP Direction Alarm	Pump is turning in the wrong direction	Alarm	See message A.13
SN BP EEPROM Error	EEPROM error	Alarm	See message E.05
SN BP EPROM Error	EPROM CRC error	Alarm	See message E.01
SN BP Erasing Error	Error erasing Flash ROM while in Service Mode	Alarm	See message E.98
SN BP Flash Error	Error copying data into Flash ROM while in Service Mode	Alarm	See message E.97
SN BP Level Up Alarm	Pressure increase when the Level Up key is pressed	Alarm	See message A.25
SN BP Pressure Alarm	Arterial pressure-read back analog voltage at X348/7 is out of limits SN pressure-read back analog voltage is out of limits	Alarm	See message A.22
SN BP RAM Error	RAM check error	Alarm	See message E.03
SN BP Rate Alarm	Pump is not reaching speed at maximum voltage	Alarm	See message A.11
SN BP Receiving Alarm	Error in received Intel-Hex-line	Alarm	See message A.28
SN BP ROM Error	Flash ROM CRC error	Alarm	See message E.02
SN BP Rotation Error	Pump rotor turning when it should not be for a second time	Alarm	See message E.23
SN BP Set Rate Alarm	Set speed-read back analog voltage at X348/14 is out of limits	Alarm	See message A.20

SN BP Stop Alarm	Pump rotor turning when it should not be	Alarm	See message A.29
SN BP Tach Alarm	Optical tachometer not in range	Alarm	See message A.24
SN BP Task Error	Software task was not completed correctly	Alarm	See message E.15
SN BP Timer Error	50 ms second time period exceeded	Alarm	See message E.14
SN BP Update Error	Transmit error during Flash update while in Service Mode	Alarm	See message E.99
SN BP Volt Error	Reference Voltage error	Alarm	See message E.04
SN BP WD Error	Watchdog timeout	Alarm	See message E.06
SN pump in use	The OLC test may not be run when the Single Needle system is in use.	Advisory	Do not attempt an OLC test when using Single Needle
Standby for Test	This message is displayed before the start of the Alarms and Pressure test	Advisory	Advisory only. No action is required.
Start Na+ greater than max. value	The operator has attempted to set a Starting Na+ higher than allowed.	Advisory	The Starting Na+ will be set to the highest allowed Na+ level. Press CONFIRM to clear message and accept the maximum allowed value. Verify that the value is acceptable or enter new value.
Start Na+ less than minimum value	Entered Start Na+ parameter is less than allowed.	Advisory	The Starting Na+ will be set to the lowest allowed Na+ level. Press CONFIRM to clear message and accept the minimum allowed value. Verify that the value is acceptable or enter new value.
Super I/O no comm	Hardware related error message	Opening Screen Message	This will only affect the use of the Single Needle pump system. If necessary, turn off the machine and try again. If the message is not cleared, alert a qualified service technician.
Switch bloodlines back	This message is a prompt for the operator return the bloodlines to their original position	Warning	To proceed, press CONFIRM .
SVS Is On!	An action has been initiated that requires the SVS to be off.	Warning	To proceed, turn the SVS option off by pressing the SVS on/off key on the control panel.
SVS not stable	An OLC test was attempted when SVS was in conductivity tracking mode.	Advisory	Wait until the SVS limit tracking phase is complete (maximum of 7 minutes) and initiated an OLC test.
SVS-Time longer than RTD	The SVS time is set for a longer period than the treatment time, RTD, which is unexpected	Dialog Message	Press CONFIRM or Escape . Verify that the RTD and SVS time are set correctly.

Message	Purpose of Message	Type	Action Required
System Leak, Can't Run	A leak was detected in the Heat Exchanger during the Chemical/Rinse program.	Warning	Exit the Chemical/Rinse program and return to the "Select Program" screen. Retry the Chemical/Rinse program. If the warning message is still not cleared, call a qualified service technician.  Note: This message means that the Chemical/Rinse program can no longer be run due to a leak detected in the Heat Exchanger. However, the machine will still be able to run Heat Disinfection programs and hemodialysis treatments per unit protocol.
Take Lines Off Shunt	An action has been initiated that requires the dialyzer supply and return lines to be off the shunt.	Warning	To proceed with the selected operation, dialyzer supply and return lines must be off the shunt. Connect lines to the dialyzer.
Target Kt/V has been set to min.	The operator has attempted to set the Target Kt/V to less than the minimum allowed	Dialog Message	The machine has set the target Kt/V to the lowest allowed target. Verify that the value is acceptable.
Temp DAC Error	The DAC (Digital/Analog conversion) for the temperature trim function is outside of its limits.	Warning	Press RESET key to reset alarm The temperature trim function will be disabled until the temperature sensors are recalibrated.
Temp Over 95 Degrees	Electronic self-test failure.	Alarm	Turn machine power off and back on. If alarm is not cleared, return the blood to the patient if alarm occurs during treatment. Take the machine out of service and alert a qualified service technician.
Temp Sensors unmatched	When the temperature trim function needs to change DAC by > 1° C, the pre and post sensors are verified against one another. This message occurs if the two temperature sensors are more than 0.5° C different.	Warning	Press RESET key to reset alarm The temperature trim function will be disabled until the machine is turned off and back on.
Temp Control not calibrated	This message is displayed on the sign on screen if the temperature sensors were not matched when they were verified against one another.	Advisory	Calibrate the temperature control.
Temperature greater than max. value	Entered Temperature value is higher than allowed.	Dialog Message	The temperature will be set to the highest allowed level. Press CONFIRM to clear message and accept the maximum allowed value. Verify that the value is acceptable or enter new value.
Temperature has been set to min.	The operator has attempted to set a Temperature lower than allowed.	Dialog Message	The temperature will be set to the lowest allowed level.
Test Complete	All selected self-tests passed.	Advisory	Advisory only. No action required.

Test Failed	The Alarm and/or PHT Sections of the automated Test Sequence have failed	Test Alarm	Reset the alarm. Check the setup to see if the alarm can be corrected and then retest. If the machine fails, turn machine power Off and back On. If alarm is still not cleared, take the machine out of service and alert a qualified service technician.
Testing temp sensor	In rare cases, the machine may be put into bypass to verify the temperature sensor. The OLC test cannot be run at this time	Advisory	Wait 10 minutes and start the OLC test again.
TMP is High (toward 500)	The TMP has exceeded the TMP high alarm limit value.	Blood Alarm	<ol style="list-style-type: none"> 1) Check the dialyzer supply and return lines for kinks and that the connectors are properly connected to the dialyzer or the shunt. 2) Clean the dialysate line filter screen. 3) Press RESET key to reset alarm. Press the Override key and hold for one second to select new alarm limits or for adjusting the TMP. If unable to reset the alarm, call your local qualified service technician. <p>High UF Goal and low dialyzer KUF coefficient can exceed the maximum TMP of 520 mmHg. The UF Goal may need to be lowered. This in turn will lower the UF rate and the TMP. Notify a physician if the UF Goal has changed.</p>
	 <p>Warning! A rising TMP may indicate a leak in the balancing system and should be investigated.</p>		<ol style="list-style-type: none"> 1) Ensure that the venous transducer protector is dry and the monitor line is open. Replace the transducer protector, if necessary. 2) Check the dialyzer supply and return lines for kinks. 3) Check the filter screen in the dialyzer return line to make sure it is clean. 4) Press RESET key to reset alarm. Press the Override key and hold for one second to select new alarm limits or for adjusting the TMP. <p> Note: Increasing the UF rate can also raise the TMP. Administer saline as prescribed. Notify a physician if the UF rate has changed.</p> <p>Note: Lowering the venous pressure by reducing the blood flow rate can also be effective, if using a high-permeable dialyzer. Notify a physician if the blood flow rate has changed.</p>
TMP is Low (alarm at or below 60)	The TMP has exceeded the TMP low alarm limit value.	Blood Alarm	<ol style="list-style-type: none"> 5) If unable to reset the alarm, return the blood to the patient if alarm occurs during treatment. Take the machine out of service and alert a qualified service technician.

Message	Purpose of Message	Type	Action Required
Tx Clock Paused?	Blood is sensed in optical detector while Tx clock is paused	Warning	Start Tx clock
UF Goal greater than max. value	Entry value for goal is out of range.	Dialog Message	Readjust UF Goal
UF Goal Reached	This message is to alert the operator that the preset ultrafiltration goal has been reached.	Warning	Press RESET to reset the alarm. The preset UF Goal has been reached and the UF Rate will drop to the minimum UF Rate. If the patient's prescribed UF Goal has not been reached, the operator must take further action to comply with the prescribed treatment.
UF Is On	An action has been initiated that requires the UF to be off.	Advisory	To proceed with the selected operation, turn the UF pump off.
UF Profile Error	A UF profile calculation error has been detected	Alarm	Reset the UF parameters
UF Pump Alarm	UF pump is not connected or is not pulsing properly.	Alarm	Press RESET to reset the alarm. If unable to clear the alarm, return the blood to the patient if alarm occurs during treatment. Take machine out of service and alert a qualified service technician.
UF Rate Error	A calculation error has been detected	Alarm	Reset the UF parameters
UF Removed cleared	This temporary message is displayed when the Tx clock is turned on the first time after the New TX key was pressed. The UF removed has been set to 0.	Advisory	No action necessary.
UF Removed not cleared	This temporary message is displayed when the Tx clock is turned on other than the first time after the New TX key was pressed. The UF removed has been <u>not</u> been set to 0.	Advisory	No action necessary.
Upper Dia. has been set to Min [Max]	The operator has attempted to set the upper diastolic pressure limit higher or lower than allowed. The machine has set the limit to the highest or lowest value allowed.	Dialog Message	Verify that the limit setting is acceptable

Upper Pulse has been set to Min [Max]	The operator has attempted to set the upper pulse rate limit higher or lower than allowed.	Dialog Message	The machine has set the limit to the highest or lowest value allowed. Verify that the limit setting is acceptable
Upper Sys. has been set to Min [Max]	The operator has attempted to set the upper systolic pressure limit higher or lower than allowed.	Dialog Message	The machine has set the limit to the highest or lowest value allowed. Verify that the limit setting is acceptable
Valve 43 Failure	Valve 43 has remained open too long	Alarm	Turn machine power off and back on. Just before beginning dialysis, verify that the dialysate flow can be turned off and back on. Do not initiate or continue dialysis if this cannot be done.
Variable Temperature	The temperature fluctuates between HIGH TEMPERATURE and LOW TEMPERATURE.	Dialysate Alarm	1) Ensure that water to the machine is turned on. 2) Check the Temperature value in the “Home” screen. Re-enter it if necessary and allow five minutes for the temperature to stabilize. If unable to attain the prescribed temperature discontinue treatment and alert a qualified service technician.
			 Caution: Do not use the Heat Disinfect cycle until the machine is repaired.
Ven. Pressure Alarm (with the upper Venous Pressure Alarm limit flashing)	High pressure detected in the venous drip chamber.	Blood Alarm	1) Check venous tubing for loose connections, kinks, clotting, or loose clamps. 2) Ensure that the transducer protector is dry and the monitor line is open. Replace the transducer protector, if necessary. 3) Check access point for clotting and needle position. 4) Press RESET to reset alarm. Press the RESET key again and hold for one second to select new alarm limits. If condition persists, reduce the blood flow rate. If alarm won't reset, return the blood to the patient if alarm occurs during treatment. Take the machine out of service and alert a qualified service technician

Message	Purpose of Message	Type	Action Required
Ven. Pressure Alarm (with the lower Venous Pressure Alarm limit flashing)	Low pressure detected in the venous drip chamber.	Blood Alarm	1) Check venous tubing for a disconnected line.
			 Note: A low venous pressure alarm does not always sound with every disconnection or needle dislodgment. Machine alarms may not occur in every blood loss situation.
			2) Ensure that the transducer protector is dry and the monitor line is open. Replace the transducer protector, if necessary. 3) Press RESET to reset alarm. Press the RESET key again and hold for one second to select new alarm limits. If you are unable to reset the alarm, return the blood to the patient if alarm occurs during treatment. Take the machine out of service and alert a qualified service technician.
Verifying temp sensors	The machine will go into bypass for about 8 minutes while the temperature sensors are verified. RTD will pause.	Advisory	Advisory only. No action is required
Wait, OLC Aborting	Changed blood pump flow rate, changed dialysate flow rate, or unstable conductivity caused on line clearance test to stop.	Advisory	Wait until stable conditions for OLC test to begin again
Wait: Rinsing Line	The machine is rinsing the concentrate lines prior to a cleaning or disinfecting program.	Advisory	Advisory only. No action is required. Line rinsing takes about 45 seconds.
WD: 24v Rcvr Err Long	Electronic self-test failure.	Alarm	Turn machine power off and back on. If alarm is not cleared, take the machine out of service and alert a qualified service technician.
WD: 24v Rcvr Err Short	Electronic self-test failure.	Alarm	Turn machine power off and back on. If alarm is not cleared, take the machine out of service and alert a qualified service technician.
WD: Fail Long Pulse	Electronic self-test failure.	Alarm	Turn machine power off and back on. If alarm is not cleared, take the machine out of service and alert a qualified service technician.
WD: Fail Short Pulse	Electronic self-test failure.	Alarm	Turn machine power off and back on. If alarm is not cleared, take the machine out of service and alert a qualified service technician.

Replacing the Diasafe Plus Filter

The Diasafe Plus filter is intended for the preparation of ultra-pure dialysate. If the machine has a Diasafe Plus filter, it should be replaced at least every 90 days (3 months). You must also replace the filter if the Diasafe test fails or shows an external leak. To replace the Diasafe Plus filter:



Warning! The use of the Diasafe Plus filter does not reduce the need for routine disinfection of your machine and RO system or routine monitoring of the chemical and bacterial water quality. The disinfection procedure is unchanged with the Diasafe Plus filter installed.



Warning! The Diasafe Plus filter can only be used in hemodialysis machines fitted with Diasafe Plus Diafix lock system kits.



Caution: Be sure to remove the plastic tabs on the Diasafe Plus filter inlet and outlet before inserting the new filter in the machine.

Note: If you instead have the DIASAFE Filter (located inside your machine), refer to P/N 490039: Diasafe Filter Operator's Instructions.

1. Lift up the lock levers on the left side of the filter mount and slide used Diasafe Plus filter up and out. Follow your clinic's instructions for disposal.
2. Fit the fresh Diasafe Plus filter in the groove at the top of the mount and slide it down until it clicks into place. Push the lock levers down again to lock the filter into its mount.
3. Test the new Diasafe Plus filter: From the "Test & Options" screen (see page 89), select the **Pressure Test** button and press **CONFIRM** to start the test. When the Pressure Holding test has passed, select the **Diasafe Test** button and press **CONFIRM** to start the test.



Warning! If the machine fails any of the tests and the cause cannot be corrected, or if it fails later tests, it should not be used for treatment. Have the machine checked by a qualified technician to correct the problem.

Warning! After replacing the Diasafe Plus filter, run a Heat Disinfect to disinfect the machine.

Replacing the 9-Volt Battery

Replace the machine's 9-Volt battery if the battery test fails in the Alarm test. Follow the instructions below:

1. Turn the machine OFF. Locate the battery on the back of the machine and push the black battery loading cartridge in and to the left. The battery cartridge will pop forward. Slide the cartridge out.

2. Power the machine ON and run the Alarm test on the “Test & Options” screen (see page 52). The machine should fail the battery test. If it passes the test, call a qualified technician.
3. Place a fresh battery in the cartridge and reinsert it back into the machine as shown in Figure 65. The negative side of the 9-Volt battery should be on top.



Warning! Do not install the 9-Volt battery backwards in the machine, as it will damage the “No Power” alarm.

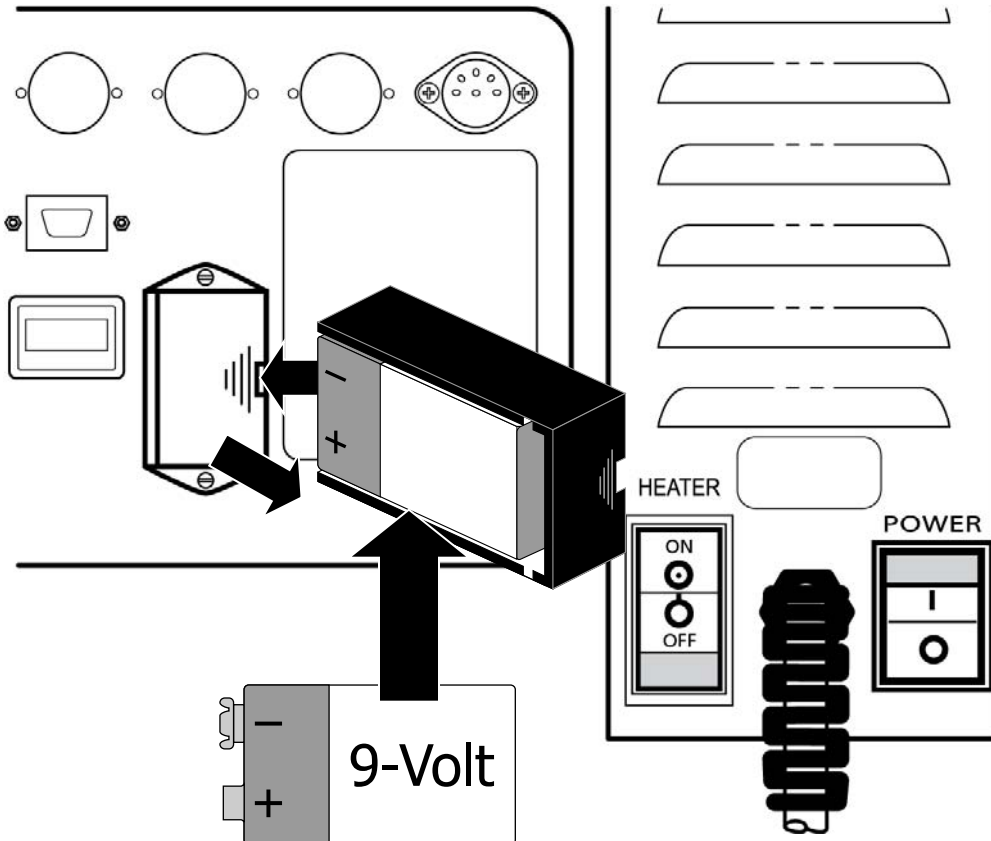

Figure 65 – Replacing the 9-Volt Battery

4. Power the machine ON and, using the main power switch on the back of the machine (see the right side of Figure 65), shut off the power to the machine. Listen for the No Power alarm, if the alarm does not sound, repeat steps 1-4.



Warning! If the machine fails these tests and the cause cannot be corrected, it should not be used for treatment. Have the machine checked by a qualified technician to correct the problem.



Note: Periodically check the power cord for damage (fraying, over-heating, cuts, scrapes, etc.)

Single Needle Dialysis (Optional)

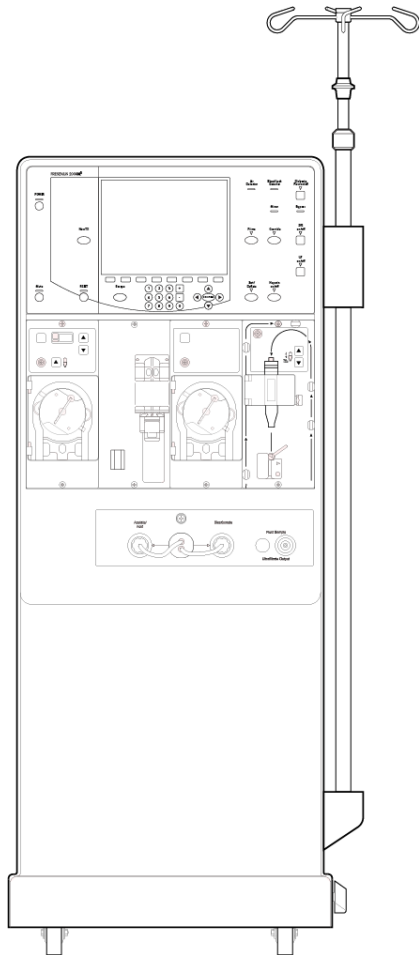

The 2008K² hemodialysis machine can be set up for either double needle dialysis (see “Preparing the Extracorporeal Blood Circuit” on page 45) or single needle dialysis. Single needle dialysis is a system that uses two blood pumps to allow blood access to the patient with a single needle. The pumps alternately cycle on and off to pull blood from the patient and return the dialyzed blood with minimal recirculation.

After setting up the concentrates (see “Preparing the Dialysis Delivery System” on page 44), use the instructions on the next page to set up the single needle bloodlines on the machine.



Note: Before using these instructions, the Single Needle Blood Pump module must be installed in the 2008K² hemodialysis machine. The Service Mode “Options: Module Options” screen Digital SN Blood Pump option must be set to ‘Yes’. See the *Single Needle 2008K Series Blood Pump Installation Instructions* (P/N 507639) for more information.

Note: The Single Needle Blood Pump module is paired with a specific arterial blood pump module. It will only work with this blood pump.

Note: Comments are available concerning the expected increased recirculation of blood in the extracorporeal circuit during a single needle treatment when using the recommended administration sets, dialyzers, catheters, and fistula needles. Contact Fresenius USA, Inc. at (800) 227-2572.

Preparing the Single Needle Extracorporeal Blood Circuit

Use Figure 66 below as a guide for connecting the bloodlines using the Single Needle Blood Pump module. The red lines on the machine are guides for the arterial bloodline (from patient to dialyzer). The blue lines on the machine are guides for the venous bloodline (from the dialyzer to the patient). Be sure to use aseptic technique for all bloodline connections.

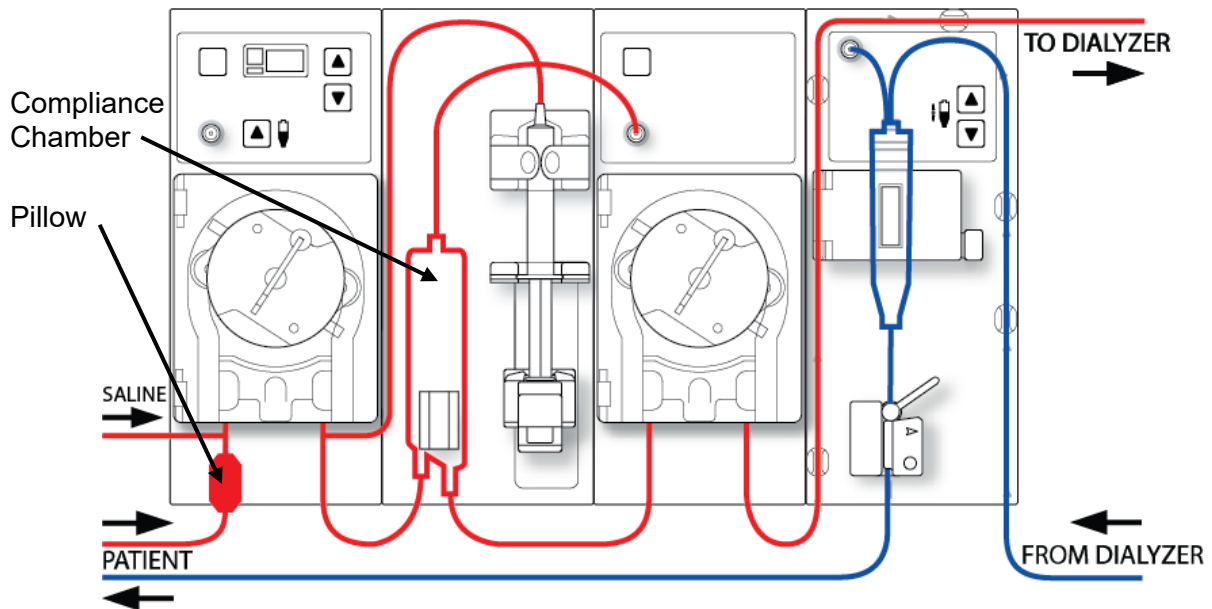

Figure 66 – Module Configuration with Digital Single Needle Pump (third module from left)

Connecting the Single Needle Extracorporeal Blood Circuit

For the following set of instructions, refer to Figure 10 – The Blood Pump Module on page 33 regarding the names of the various blood pump parts. Refer to Figure 12 – The Level Detector Module on page 35 regarding the names of the various Level Detector module parts.

To connect the bloodlines:



Warning! Use aseptic technique.



Note: These instructions are for Fresenius Medical Care CombiSet Single Needle Bloodlines (P/N 03-2696-7) using a new, dry-pack dialyzer. If you use a different bloodline set, your medical director is responsible for providing alternate instructions.

Fresenius Medical Care manufactures bloodlines for use with the 2008K² hemodialysis machine. The performance of bloodline sets not manufactured by Fresenius Medical Care cannot be guaranteed by Fresenius Medical Care and are therefore the responsibility of the prescribing physician.

Arterial Bloodline Setup

1. Close the medication port clamp located on the short line at the top of the compliance chamber.
2. Snap the compliance chamber into its holder.
3. Connect the arterial monitor line to the pressure port (P_{SN}) on the Single Needle Blood Pump module using a transducer protector. Verify that the monitor line is unclamped.



Warning! Transducer protectors should be used between transducers and each pressure monitor line of the extracorporeal system to prevent the transducers from getting wet. Wet transducer protectors must be replaced, as they will cause inaccurate pressure readings. If the external transducer protector and the internal transducer should become contaminated with blood, the transducer protectors **must** be replaced, and the transducer must be disinfected or replaced.

4. Locate the “pillow” on the patient end of the arterial bloodline; the pump segment directly above the pillow is the first blood pump segment, this pump segment should be loaded into the arterial blood pump (the first blood pump from the left).
5. Open the arterial blood pump door.



Warning! Inspect the blood pump rotor for proper operation (tubing guide posts not bent, rollers move freely, crank lever moves freely). Bent or loose tubing guide posts can damage bloodlines. Replace rotor if necessary. See page 128 for rotor diagram.

6. If necessary, set the Arterial Blood Pump module for the diameter of the blood pump segment:
 - Press the Up (▲) and Down (▼) keys on the Arterial Blood Pump module simultaneously. The display will flash.
 - Press the Up (▲) or Down (▼) key on the Arterial Blood Pump module until the diameter of the pump segment (8.0) being used is displayed.
7. Load the arterial blood pump segment into the arterial blood pump:
 - a. Press and hold the **Start/Stop** key on the Arterial Blood Pump module to align the pump rotor for line insertion.
 - b. Grasp the pump segment and, using thumb pressure, position it behind the left yoke by pressing the tubing retainer inward. Be sure the end of the segment clears the bottom of the yoke.



Warning! Make sure the collar of the pump segment is positioned below the bottom of the yoke. This will minimize the possibility of the segment kinking during pump operation.

- c. Press and hold the **Start/Stop** key. The rotor will rotate to the 5 o’clock position and stop. Relieve pressure on the retainer and release the segment. The beginning of the pump segment should be secured between the left yoke and the tubing retainer.



Warning! Keep fingers free of rotor while it is turning to avoid possible injury.

- d. Press and hold the **Start/Stop** key again and the rotor will rotate one full turn to automatically position the remainder of the segment within the pump housing. After loading, any extra pump segment tubing length should be on the right side of the pump.

- e. Release the **Start/Stop** key when the pump segment has been inserted along the track inside the pump housing all the way to the right yoke.
 - f. Grasp the remaining portion of the segment and, using thumb pressure in a manner similar to step b, position it behind the right yoke.
 - g. Release the tubing retainer and close the pump door. Be sure the pump segment is free of kinks and both ends of the segment extend below the yoke.
8. Drape the second blood pump segment over the top of the single needle blood pump—do not insert the single needle blood pump segment into the single needle blood pump at this time.
 9. Snap remaining arterial tubing in the clips along the red guidelines shown on modules.
 10. Aseptically connect the patient end of the arterial line to the priming receptacle. Snap the dialyzer end of the arterial bloodline into the dialyzer holder clip.



Warning! Do not allow the ends to touch the fluid in the bucket to prevent contamination.

Venous Bloodline Setup

1. Close medication port clamp
2. Open the level detector door and roll the venous drip chamber into its holder with the filter below the sensor heads. Close and latch the door.



Warning! The level detector must be calibrated to the venous line model being used.

Warning! If the venous chamber contains a filter, be sure the filter portion of the chamber is positioned below the ultrasonic sensor heads of the drip chamber holder.

3. Connect the venous pressure monitor line to the pressure port. Be sure to insert a transducer protector between the line and the port. Verify that the monitor line is unclamped.



Warning! Transducer protectors should be used between transducers and each pressure monitor line of the extracorporeal system to prevent the transducers from getting wet. Wet transducer protectors must be replaced, as they will cause inaccurate pressure readings. If the external transducer protector and the internal transducer should become contaminated with blood, the transducer protectors **must** be replaced, and the transducer must be disinfected or replaced.

4. Snap remaining venous tubing in the clips along the blue guidelines shown on modules (do not insert the venous bloodline into the venous clamp yet).
5. Snap the dialyzer end of the venous bloodline into the dialyzer holder clip.
6. Aseptically connect the patient end of the venous line to the priming receptacle.



Warning! Do not allow the ends to touch the fluid in the bucket to prevent contamination.

Dialyzer Setup

1. Mount the dialyzer in its holder, arterial-end up. Screw dialyzer caps onto the dialyzer ports.

Priming the Single Needle Blood Circuit

There are two different ways to prime the blood circuit on the 2008K² hemodialysis machine:

- Standard Prime method: This method allows the operator to prime the blood circuit by controlling the flow of the saline manually.
- Prime Amount method: This method limits the amount of saline used in the priming procedure to a preset volume. The preset volume (Prime Amount) is set in Service Mode.

Prime the blood circuit according to how your machine was set up. Follow your unit protocol or dialyzer manufacturer's instructions for priming and rinsing dialyzers.

Standard Prime Method

1. Connect the dialyzer end of the arterial bloodline to the arterial port of the dialyzer. Rotate the dialyzer to the arterial end down position.
2. Connect the dialyzer end of the venous bloodline to the venous port of the dialyzer.
3. Insert the venous bloodline into the venous line clamp and optical detector on the Level Detector module. Close the optical detector door.



Warning! The tubing beneath the venous drip chamber must be inserted into the venous line clamp and the optical detector.

4. Hang a saline bag and attach an administration line to the saline port on the arterial bloodline below the arterial blood pump. Aseptically spike the saline bag.
5. Gravity prime the patient end of the arterial bloodline below the saline “T” with saline. When primed, clamp the patient end of the arterial bloodline.
6. If the heparin pump is to be used: connect the heparin syringe, prime the heparin line with heparin, and load the heparin syringe into the Heparin Pump module. If the heparin pump is not used, clamp the heparin line.
7. Press the **Prime** key on the control panel.
8. Press the **Start/Stop** key on the Arterial Blood Pump module and run the pump at a rate of 150 ml/min. Adjust the flow rate by pressing the ▲ (up) or ▼ (down) keys. The compliance chamber will automatically fill to an acceptable level.



Warning! The ▲ **Level Adjust** key on the Arterial Blood Pump module can only be used to raise the level in the compliance chamber. Do not press the ▲ **Level Adjust** key so long that the pressure transducer protector becomes wet. Wet transducer protectors must be replaced to avoid erroneous pressure readings.

9. Run the arterial blood pump to flush additional saline through the dialyzer until a fluid level is detected in the venous drip chamber. The blood pump will stop when the level detector detects an acceptable level of fluid.

10. Press the **RESET** key on the control panel to restart the arterial blood pump and continue flushing saline through the blood circuit in accordance with established facility protocol regarding dialyzer rinsing.
11. After the required saline amount has passed through the dialyzer, press the **Start/Stop** key on the Arterial Blood Pump module to stop the pump.
12. Clamp the patient end of the venous bloodline.
13. Adjust the fluid level in the venous drip chamber by pressing the appropriate ▲ or ▼ level adjust keys on the Level Detector module. Close the venous pressure monitor line clamp and disconnect the monitor line from the venous pressure port so the port is open to atmosphere.
14. Aseptically connect the patient end of the arterial bloodline to the patient end of the venous bloodline using a sterile recirculation piece. Unclamp both lines.
15. Set the arterial blood pump rate to 350-400 ml/min. Press the **Start/Stop** key on the Arterial Blood Pump module to start the pump and begin recirculation. Do not insert the single needle blood pump segment into single needle blood pump. If necessary, press the **RESET** key to clear any alarms.
16. Ensure that the extracorporeal blood circuit is free of air bubbles.



Note: The dialysate lines will have to be attached at the appropriate point during the priming process, depending on facility procedure and manufacturer's instructions. If 1.5x or 2x dialysate flow (Auto Flow) is selected, be sure that the dialysate flow rate is at least the minimum required rate.

Prime Amount Method

1. Connect the dialyzer end of the arterial bloodline to the arterial port of the dialyzer. Rotate the dialyzer to the arterial end down position.
2. Connect the dialyzer end of the venous bloodline to the venous port of the dialyzer.
3. Hang a saline bag and attach an administration line to the saline port on the arterial bloodline below the arterial blood pump. Aseptically spike the saline bag.
4. Gravity prime the patient end of the arterial bloodline below the saline "T" with saline. When primed, clamp off the patient end of the arterial bloodline.
5. If the heparin pump is to be used: connect the heparin syringe, prime the heparin line with heparin, and load the heparin syringe into the Heparin Pump module. If the heparin pump is not used, clamp the heparin line.
6. Press the **Prime** key on the control panel.
7. Press the **Start/Stop** key on the Arterial Blood Pump module and run the pump at a rate of 150 ml/min. Adjust the flow rate by pressing the ▲ (up) or ▼ (down) keys. The compliance chamber will automatically fill to an acceptable level.



Warning! The **▲ Level Adjust** key on the Arterial Blood Pump module can only be used to raise the level in the compliance chamber. Do not press the **▲ Level Adjust** key so long that the pressure transducer protector becomes wet. Wet transducer protectors must be replaced to avoid erroneous pressure readings.

8. The arterial blood pump will start and continue to run until the pre-set amount of saline has been flushed through the circuit. When the blood pump stops, clamp the patient end of the venous bloodline.
9. Insert the venous bloodline into the venous line clamp and optical detector on the Level Detector module. Close the optical detector door.



Warning! The tubing beneath the venous drip chamber must be inserted into the venous line clamp and the optical detector.

10. Adjust the fluid level in the venous drip chamber by pressing the appropriate **▲** or **▼** level adjust keys on the Level Detector module. Close the venous pressure monitor line clamp and disconnect the monitor line from the venous pressure port so the port is open to atmosphere.
11. Aseptically connect the patient end of the arterial bloodline to the patient end of the venous bloodline using a sterile recirculation piece. Unclamp both lines.
12. Set the arterial blood pump rate to 350-400 ml/min. Press the **Start/Stop** key on the Arterial Blood Pump module to start the pump and begin recirculation. Do not insert the single needle blood pump segment into single needle blood pump. If necessary, press the **RESET** key to clear any alarms.
13. Ensure that the extracorporeal blood circuit is free of air bubbles.



Note: The dialysate lines will have to be attached at the appropriate point during the priming process, depending on facility procedure and manufacturer's instructions. If 1.5x or 2x dialysate flow (Auto Flow) is selected, be sure that the dialysate flow rate is at least the minimum required rate.

Testing the 2008K² hemodialysis machine with Single Needle blood pump

Follow the instructions in the “Testing the 2008K² Hemodialysis Machine” section on page 52.

Recirculation and Final Set-Up Procedure with Single Needle Blood Pump



Note: If you are using a reused dialyzer, you cannot run recirculation with the single needle blood pump segment inserted. Recirculation is achieved with the arterial blood pump.

1. Rotate the dialyzer to arterial inlet up.
 2. Check the conductivity and pH of the dialysate and test for residual disinfectant before connecting the dialysate lines to the dialyzer.
-



Warning! Always verify the conductivity and approximate pH of the dialysate solution through independent means (e.g. using a conductivity meter or pH paper or meter, as applicable) before initiating each dialysis treatment. Verify that the conductivity is reasonably close to the theoretical conductivity value (TCD) and the pH is between 6.9 and 7.6. If they are not, do not initiate dialysis.

3. Connect the dialysate lines to the dialyzer by matching the color of the dialyzer connector to the color of the blood tube fitting and then close the shunt door. When done correctly, the red arterial blood tubing connector and the red dialyzer connector of the dialysate line should be connected to the corresponding ports at the top of the dialyzer. This is to create a counter-current flow (blood flowing from top to bottom, dialysate flowing from bottom to top) inside the dialyzer to maximize clearance.
 4. Pull on the dialyzer connectors to make sure they are firmly connected to the dialyzer.
-



Note: All dialyzer connectors must be fastened tightly to prevent air from entering the dialysate circuit or to prevent dialysate from leaking from the dialyzer.

5. Reconnect the venous monitor line to the venous pressure port. Unclamp the venous pressure monitor line.
 6. When the dialysate compartment is filled, rotate the dialyzer so the arterial inlet is down.
 7. After priming the extracorporeal blood circuit, press **RESET** to clear all alarms. Set the blood pump rate to 350-400 ml/min and start the blood pump to begin recirculating the saline through the circuit.
 8. Press the ▼ (down) key on the Level Detector module to lower the fluid level in the drip chamber. Verify that the blood pump stops and the venous clamp occludes.
-



Warning! The test of the level detector system must be run as a precaution and aid to identifying potential failures. Remove the machine from service if it fails this test.

9. Press the ▲ (up) key on the Level Detector module to raise the fluid level in the drip chamber to an acceptable level.
10. Check blood tubing to ensure that there are no kinks, especially between the blood pump and the dialyzer.



Warning! Kinked lines can cause hemolysis of the blood.

Warning! If using a dialyzer that has been stored in a liquid disinfectant such as formaldehyde or Puristeril 340, test the recirculating saline solution for residual disinfectant according to established facility protocol or the manufacturer’s instructions. Special rinsing techniques must also be employed to assure the concentration of disinfectant is reduced and maintained at an appropriate level. These rinsing procedures are the responsibility of the medical director. The procedure must include a test for residual disinfectant and techniques to avoid rebound of the disinfectant. Turning the dialysate flow off when using a reused dialyzer may allow the chemical disinfectant to rebound (increase) to an unacceptable level.

11. Replace the saline bag with a fresh bag if necessary.
 12. Check for a normal dialysate flow by observing the rise and fall of the external flow indicator located on the dialyzer supply line. The float should drop four times in about 15 seconds for a 500 ml/min flow, or four times in 10 seconds for an 800 ml/min flow.
 13. Open the shunt door and verify that the machine goes into bypass mode. In bypass mode, the float in the flow indicator of the dialyzer supply line should drop and remain at the bottom of the indicator and an audible alarm may sound.
-



Note: The 2008K² hemodialysis machine can be configured (in Service Mode) so that audible alarms occur only when the optical detector senses blood. If this option is not selected, an audible alarm will sound when the shunt interlock door is open.

Setting Single Needle Dialysis Treatment Parameters

Follow the instructions in the “Setting Treatment Parameters” section on page 57. The Single Needle option on the “Test & Options” screen will be set after inserting the single needle blood pump segment in the next section.

Starting Single Needle Dialysis

At this point, all treatment parameters and options should be entered. Dialysate should already be verified for absence of disinfectant, verification of prescription, conductivity, and pH should also be confirmed. It is now time to insert the single needle blood pump segment and connect the patient to the 2008K² hemodialysis machine via the blood tubing and begin the dialysis treatment.

1. Press the **Start/Stop** key on the Arterial Blood Pump module to stop the blood pump.
 2. Open the single needle blood pump door to insert the single needle blood pump segment.
-



Warning! Inspect the blood pump rotor for proper operation (tubing guide posts not bent, rollers move freely, crank lever moves freely). Bent or loose tubing guide posts can damage bloodlines. Replace rotor if necessary. See page 128 for rotor diagram.



Caution: If you are using a Single Knob Single Needle Blood Pump module, you must make sure that the pump is set for the diameter of the blood pump segment.



Note: If you are using a Single Knob Single Needle Blood Pump module, you must manually load the single needle blood pump segment: Thread the single needle blood pump segment into the single needle pump using the rotor latch (see Figure 55 #1 on page 120) to rotate the single needle pump rotor clockwise. Make sure the left and right pump segment connectors are positioned below the left and right yokes and the line is free from kinks.

3. Load the single needle blood pump segment:
 - a. Press and hold the **Start/Stop** key on the Single Needle Blood Pump module to align rotor for line insertion.
 - b. Grasp the pump segment and, using thumb pressure, position it behind the left yoke by pressing the tubing retainer inward. Be sure the end of the segment clears the bottom of the yoke.



Warning! Make sure the collar of the pump segment is positioned below the bottom of the yoke. This will minimize the possibility of the segment kinking during pump operation.

- c. Press and hold the **Start/Stop** key. The rotor will rotate to the 5 o'clock position and stop. Relieve pressure on the retainer and release the segment. The beginning of the pump segment should be secured between the left yoke and the tubing retainer.



Warning! Keep fingers free of rotor while it is turning to avoid possible injury.

- d. Press and hold the **Start/Stop** key again and the rotor will rotate one full turn to automatically position the remainder of the segment within the pump housing. After loading, any extra pump segment tubing length should be on the right side of the pump.
 - e. Release the **Start/Stop** key when the pump segment has been inserted along the track inside the pump housing all the way to the right yoke.
 - f. Grasp the remaining portion of the segment and, using thumb pressure in a manner similar to step b, position it behind the right yoke.
 - g. Release the tubing retainer and close the pump door. Be sure the pump segment is free of kinks and both ends of the segment extend below the yoke.
4. On the “Test & Options” screen, set the **Single Needle** toggle-button to ‘On’ (by pressing the **CONFIRM** key with the **Single Needle** toggle-button selected, then using the round left arrow key on the Navigation Keypad to select ‘On’ and pressing **CONFIRM**).
5. Press the **Start/Stop** key on the Arterial Blood Pump module to start the blood pump.



Note: If using a Single Knob Single Needle Blood Pump module, set the single needle blood flow rate to approximately 20% higher than the arterial blood pump rate. The blood flow rate displayed on the Arterial Blood Pump module with the Single Needle option set to ‘On’ equals the average blood flow rate for both pumps.

Note: Allow the system to recirculate several times before connecting the patient to assure that the extracorporeal circuit is ready.

6. Before starting dialysis, complete the patient assessment per unit policy.
7. Wrap the blood pressure cuff around the patient’s non-access arm.



Warning! Be sure the cuff is the correct size and placed at heart level. An improperly fitted cuff may cause inaccurate blood pressure readings due to under or over compression of the brachial artery. Each centimeter above or below heart level will cause an error of ± 0.8 mmHg.

8. Verify that ultrafiltration is off (UF light is off), and that the **UF Removed** button is reset to zero. The UF removed may be reset by selecting the **UF Removed** button and then pressing the **0** key and confirming the change.
9. Verify that the venous line is in the venous clamp and the optical detector. Verify that the optical detector door is closed.



Warning! Do not infuse the recirculated saline prime into the patient. Discard the recirculated saline and fill the extracorporeal circuit with fresh saline prior to connecting to the patient. The volume of fresh saline used to fill the extracorporeal circuit should be equal to the volume of the dialyzer and blood tubing set in use.



Note: Follow established unit protocol regarding procedures for establishing aseptic blood connections.

10. Lower the arterial blood pump rate to 150 ml/min and then press the **Start/Stop** key on the Arterial Blood Pump module to stop the pump.
11. Connect the patient and initiate treatment according to unit protocol.



Warning! Check all bloodline and dialysate line connections for fluid leaks. Keep access sites uncovered and monitored. Improper bloodline connections or needle dislodgements can result in excessive blood loss, serious injury, and death. Machine alarms may not occur in every blood loss situation.

12. Start the arterial blood pump and adjust the blood flow rate to establish dialysis and the alarm limits. Establish the prescribed blood flow rate. When the pressure in the compliance chamber reaches 180 mmHg, the arterial pump will stop and the single needle pump will start. When the pressure in the compliance chamber drops to 80 mmHg, the single needle blood pump stops and the arterial blood pump starts again. The pumps continue to cycle in this manner for the duration of the treatment.

13. Rotate the dialyzer to arterial inlet up.
14. Select the **Tx Clock** button and press **CONFIRM** to start the treatment.
15. Check that the UF/SVS/Heparin are on, if prescribed. If applicable, a blood pressure measurement is initiated.



Warning! When establishing blood flow, ensure that air will not be infused into the patient.

Warning! Check all bloodlines for kinking. Improper blood flow may cause hemolysis of the blood.

Monitoring the Single Needle Dialysis Treatment

Follow the instructions in the “Monitoring the Treatment” section on page 96.



Warning! Administration of intravenous solution during single needle operation requires the use of a sterile one-way valve between the administration set and the infusion site to prevent back up of solution.

Single Needle Alarms and Troubleshooting

Follow the instructions in the “Alarms and Troubleshooting” section on page 138.

Blood Recirculation Procedure during Single Needle Dialysis

Follow the instructions in the “Blood Recirculation Procedure” section on page 118.

Power Failure during Single Needle Dialysis

Follow the instructions in the “Power Failure during Dialysis” section on page 119.

Completion of the Single Needle Dialysis Treatment

At the end of treatment, when the RTD timer has counted down to 0:00, an alarm sounds and the message, RTD = ZERO, appears in the Status Box. An alarm also sounds when the set amount of ultrafiltrate has been removed. When that happens, the Status Box displays the message, UF GOAL REACHED. To reset either alarm, press the **RESET** key. If the UF GOAL REACHED and RTD = ZERO alarms occur simultaneously, pressing the **RESET** key will reset both alarms.

Returning Blood to the Patient

1. Select the **Tx Clock** button and then press the **CONFIRM** key to stop the treatment
2. Press the **Start/Stop** key on the Arterial Blood Pump module to stop the pump
3. On the “Test & Options” screen, set the **Single Needle** toggle-button to ‘Off’ (by pressing the **CONFIRM** key with the **Single Needle** toggle-button selected, then using the round left arrow key on the Navigation Keypad to select ‘Off’ and pressing **CONFIRM**).
4. Remove the single needle blood pump segment from the single needle blood pump:
 - a. Open the door and align the rotor by pressing and holding the **Start/Stop** key until the pump stops.

- b. Press the clamp-panel below the rotor to release the left (incoming) side of the pump segment. Pull the first couple of inches of the pump segment out of the pump.
 - c. While keeping firm tension outward on the left (incoming) side of the bloodline, press and hold the **Start/Stop** key a second time and the pump segment will be released from the pump head.
5. Replace saline bag with a fresh bag if necessary
6. Rinse the blood in the bloodline back to the patient:
 - a. Clamp the arterial bloodline directly below the saline “T”
 - b. Open the saline line clamps
 - c. Start the blood pump and set a rate of 150-200 ml/min
 - d. When the blood has been returned to the patient, turn the blood pump off and close the saline line clamps
7. Rinse the remaining blood in the arterial bloodline back to the patient:
 - a. Remove the clamp from below the saline “T” and then clamp the arterial bloodline directly above the saline “T”
 - b. Open the saline line clamps
 - c. When the blood has been returned to the patient, close the saline line clamps



Warning! Check all bloodlines and dialysate lines for leaks. Keep access sites uncovered and monitored. Improper bloodline connections or needle dislodgements can result in excessive blood loss, serious injury, and death. Machine alarms may not occur in every blood loss situation.

8. Clamp the arterial and venous bloodlines and the patient’s arterial and venous access lines, and aseptically disconnect them.
-



Note: Depending on how your machine was configured, an audible alarm may sound when the saline solution reaches the optical sensor. Press **RESET** to silence the alarm.

Continue with the instructions listed in the “Removing the Dialyzer” section on page 123.

Sustained Low Efficiency Dialysis (SLED) (Optional)

Sustained Low Efficiency Dialysis (SLED) is an option used in a critical-care facility for patients requiring temporary, short-term dialysis treatment due to trauma or hemodynamic instability. Unlike dialysis treatment for patients with chronic kidney disease, patients are dialyzed continuously over a longer period of time, up to twelve hours. With SLED treatments, the dialysate flow rate is set between 100–300 ml/minute and the blood flow rate is 300 ml/min or less.

For the most part, preparing the 2008K² hemodialysis machine and setting treatment parameters in the SLED Mode are the same as in the Dialysis Mode. This appendix identifies and addresses SLED issues that are not covered in the earlier chapters of this manual. As with normal dialysis, all treatment parameters must be prescribed by a physician.



Note: The Diasafe Filter Service Mode option must be set to ‘Yes’ in order to use SLED Mode.

Preparation

The water and dialysate supplied for treatment must meet ANSI/AAMI standards for dialysis. If a reverse osmosis (RO) water treatment unit is used, follow the manufacturer’s instructions regarding set up and testing procedures. Check RO-processed water for residual disinfectant and make sure the water is within acceptable limits before connecting the water supply to the 2008K² hemodialysis machine.

To prepare the 2008K² hemodialysis machine for SLED, follow the instructions in Chapter 2, “Daily Preparation for Treatment.”



Note: Indicate on the concentrate jugs the date and time the bicarbonate was mixed or opened to ensure solution stability.

When setting patient-specific, treatment parameters, follow the instructions in Chapter 3, “Setting Treatment Parameters.” Some notable exceptions to chapter 3 are:

- UF or SVS profiles are not available in SLED
- No UF Time, UF Goal, or RTD to set in SLED
- No Low Volume option on the “Test & Options” screen
- No “Trends,” “Kt/V AF,” and “BTM BVM” screens

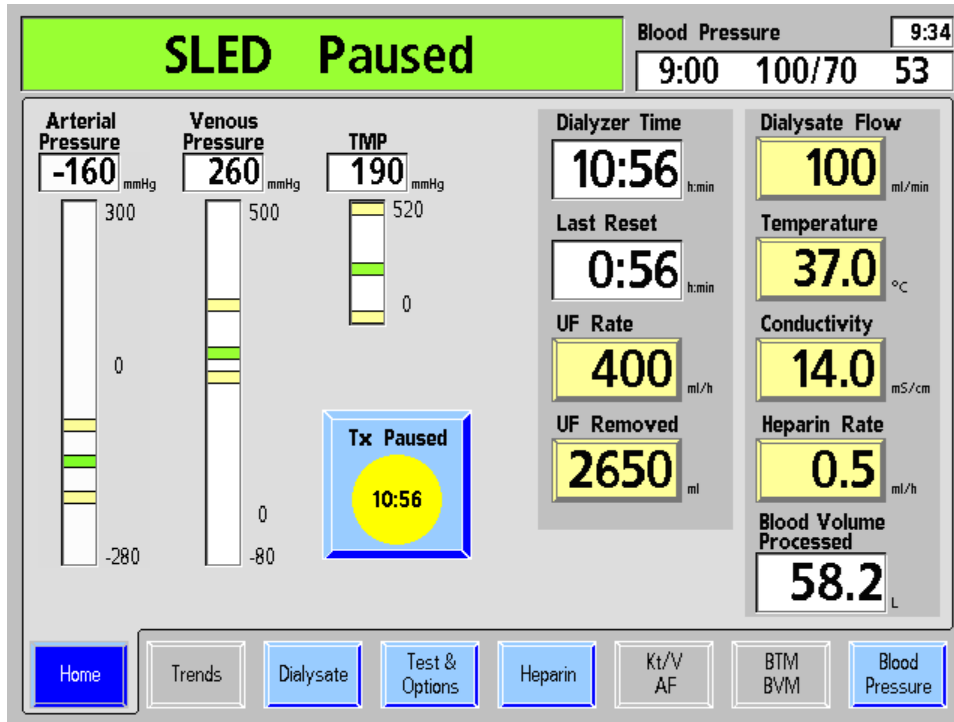
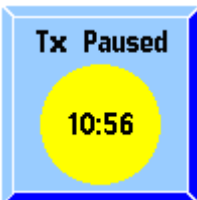



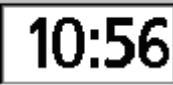
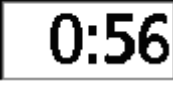

Figure 67 – The SLED “Home” screen

The following table describes the features that are unique to the SLED “Home” screen. For descriptions of features not shown in the table, see the table of descriptions for the Dialysis “Home” screen buttons on page 72.

Table 34 – SLED “Home” Screen Features

Feature	Function
	<p>The Treatment Clock button displays the time the SLED treatment has been running (in hours:minutes); this time is limited to 12 hours and does not increment if the blood pump is stopped or if there is a water alarm. Selecting and confirming the Tx Clock button will start or pause the treatment.</p> <p>When the treatment is paused, the treatment time stops incrementing, the heparin infusion time stops counting down, and the UF and heparin pumps stop. The appropriate LED indicators will flash. Turning the Treatment Clock back on will restore operation of these parameters unless turned off with the respective front panel on/off key.</p> <p>The first time the Treatment Clock is turned on, the UF Removed is reset to 0, the UF and the heparin pumps are turned on, and a blood pressure reading is taken, if applicable.</p> <p>When the Treatment Time displayed in the button reaches 12:00, the non-resettable warning “SLED Complete” is displayed in the Status Box, an alarm sounds, the dialysate flow stops, and the UF pump stops.</p>
	

APPENDIX A

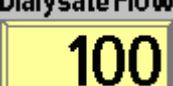
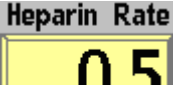
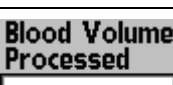
Feature	Function
Dialyzer Time 	The Dialyzer Time meter box acts as a timer that displays elapsed time (in hours:minutes) that the dialysate lines have been connected to the dialyzer with blood sensed. The timer begins when the Tx Clock button is selected and confirmed to start treatment, changing from 'Tx Paused' to 'Tx Running'. The Dialyzer Time value resets to zero when the dialysate lines are placed on the shunt.
Last Reset 	The Last Reset data box displays the amount of time (in hours:minutes) since the UF Removed button was reset to zero. This value automatically resets when UF Removed is set to 0.
UF Rate 	Enter here, in 10 ml/hr increments, the rate fluid will be drawn from the patient (ultrafiltration). For SLED Mode, the UF rate is limited to a maximum of 1000 ml/hr.
Dialysate Flow 	The prescribed dialysate flow rate, in ml/min, is entered here. For SLED Mode, the dialysate flow rate can be set to 100, 150, 200, or 300 (default) ml/min.
Heparin Rate 	The Heparin Rate button displays the rate at which heparin is dispensed during treatment. It can be set from 0.0 to 9.9 ml/hour. Setting the rate to 0 turns off the heparin pump. The rate can be adjusted from the "Home" screen or the "Heparin" screen.
Blood Volume Processed 	The Blood Volume Processed meter box displays, in liters, the amount of blood that has passed through the dialyzer since the last dialyzer time reset.

Additionally, the blood pump module is limited to a pump rate of 300 ml/min in SLED Mode.

Treatment Monitoring

Refer to Chapter 4, "Monitoring the Treatment," for descriptions of the screen features used to monitor the progress of the treatment. Per hospital policy, the dialysis nurse or ICU staff should record the initial parameters of the treatment as well as at fixed intervals. Because the UF Rate reflects only the rate at which fluid is removed from the patient, all fluid intakes (IV solution, nutrition, medication, etc.) and outputs (UF Rate, residual kidney function, drainage, etc.) have to be considered for determining fluid balance of the patient. It may be necessary to readjust the UF rate hourly.

With each check, the dialysis nurse or ICU staff should ensure that enough heparin and acid and bicarbonate concentrates is available for the next hour to prevent unnecessary alarms.

Dialyzer Replacement

The 2008K² hemodialysis machine should be heat (or chemical) disinfected and the complete extracorporeal circuit, including the dialyzer, should be replaced according to hospital policy. After a maximum of 12 hours treatment, the machine will display the non-resettable message “SLED Complete” and ultrafiltration and dialysate flow will stop.

After 12 hours of treatment:

1. Record the treatment parameters
2. Select the **Tx Clock** button and press **CONFIRM** to pause the treatment.
3. Follow the procedures in Chapter 4, “Returning Blood to the Patient” and “Removing the Dialyzer.”



Warning! If UF Removed value is not cleared, the fluid balance may be miscalculated.

Warning! Check all bloodlines and dialysate lines for leaks. Keep access sites uncovered and monitored. Improper bloodline connections or needle dislodgements can result in excessive blood loss, serious injury, and death. Machine alarms may not occur in every blood loss situation.

4. From the “Select Program” screen, select **Heat Disinfect** and press **CONFIRM**. During heat disinfection, the RO unit, if used, can be disconnected from the 2008K² hemodialysis machine once the water temperature reaches 80 °C and the recirculation cycle starts. If an RO unit equipped with a softener is used, check the hardness level and, following the manufacturer’s instructions, regenerate the softener per facility policy.
5. When Heat Disinfection is completed, reconnect the water supply (if necessary) and run a Rinse program from the “Select Program” screen to cool down the machine.
6. After the Rinse cycle, repeat the set-up procedure (including the Alarm and Pressure tests) and resume SLED as prescribed.

This page intentionally blank

Concentrate Types

The 2008K² hemodialysis machine can be set up for various concentrate types. If a bicarbonate-type concentrate is to be used, both bicarbonate concentrate and acid concentrate must be connected to the machine. The specific bicarbonate type is selected in Service Mode during calibration. Bicarbonate solution is not stable over time. Make a fresh batch for each treatment according to the manufacturer's instructions.







Warning! The machine must be labeled to indicate the type of concentrate for which it is configured. Check the composition (i.e., Na, Cl, K, Ca, Mg, HCO₃) and pH of the dialysate solution after the machine is installed or after the machine is modified for different concentrate types. Check the conductivity and approximate pH of the dialysate solution with an independent device before initiating dialysis. Improper conductivity or pH could result in patient injury or death.

The table on the following page provides a data reference for ensuring the compatibility of the concentrates selected and instructions on the proper mixtures ratios.



Warning! Acetate concentrates are used individually with the machine. No bicarbonate concentrate is used. The 2008K² hemodialysis machine is a standard 1:34 proportioning machine. When it is at a facility that uses 1:44 acid, be sure to use the keys and labeling as indicated. Use of 1:44 acid with a 1:34 acetate machine may cause patient injury or death.

Table 35 – Concentrates Data

	35X 	36.83X (Salt Spiked Bicarbonate) 	45X 	36.1X 	Acetate
Base Mix Ratio Acid : Bicarb : Water : Total	1 : 1.23 : 32.77 : 35	1 : 1.83 : 34 : 36.83	1 : 1.72 : 42.28 : 45	1 : 1.26 : 33.84 : 36.1	(Acetate : Water) 1 : 34 : 35
Na ⁺ @ base mix ratio	138 mEq/l	138 mEq/l	137 mEq/l	138 mEq/l	N/A
Bicarbonate @ base mix ratio after reaction	32 mEq/l (35-3)	35 mEq/l (39-4)	33 mEq/l (37-4)	32 mEq/l (36-4)	N/A
Acid Concentrate Mix Ratio Acid : Other	1 : 34	1 : 35.83	1 : 44	1 : 35.1	1 : 34
Bicarbonate Concentrate Mix ratio Bicarbonate : Other	1 : 27.46	1 : 19.13	1 : 25.16 (Bic = 81.25g/L)	1 : 27.6	N/A
Sodium Bicarbonate Concentrate composition	84.0 g/L NaHCO ₃	65.95 g/L NaHCO ₃ + 23.53 g/L NaCl	81.25 g/L or 79.25 g/L or 72 g/L NaHCO ₃	84.0 g/L NaHCO ₃	<u>None</u>

Adding New Concentrates or Changing the Type

New concentrates can be either selected from a pre-programmed list or by entering the concentrate manually. This process is performed in Service Mode.

Step 1

Power the machine On into Service Mode by pressing the **CONFIRM** key when prompted during the power up sequence.

Step 2

Press the **Options** screen-key (the key directly below the screen-button) and then press the round right arrow key on the Navigation Keypad until the **Enter Conc.** screen-button is selected. Press the **CONFIRM** key to view the “Enter Conc” screen.

Step 3

Verify that the correct family of concentrates is selected. If it is not, select **Change Type** and select the correct family using the **+** or **-** (plus/minus) keys on the data entry keypad.

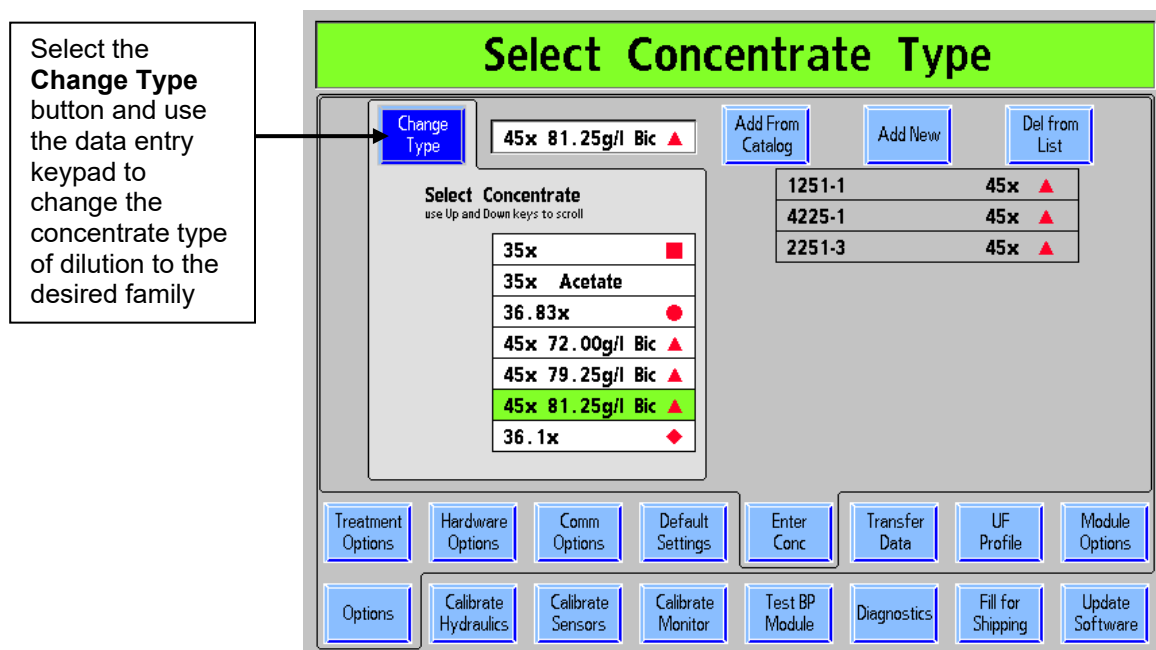

Figure 68 – Selecting the Concentrate Type

Step 4

Do one of the following:

- Select **Add from Catalog** if the concentrate is available in the pre-programmed list or
- Select **Add New** and create a new concentrate manually.

To add a concentrate from pre-programmed catalog:

Select the **Add From Catalog** button and press **CONFIRM**. A list of the pre-programmed concentrates for the selected concentrate family will appear. Highlight the desired concentrate by using the data entry keypad and then pressing **CONFIRM**.

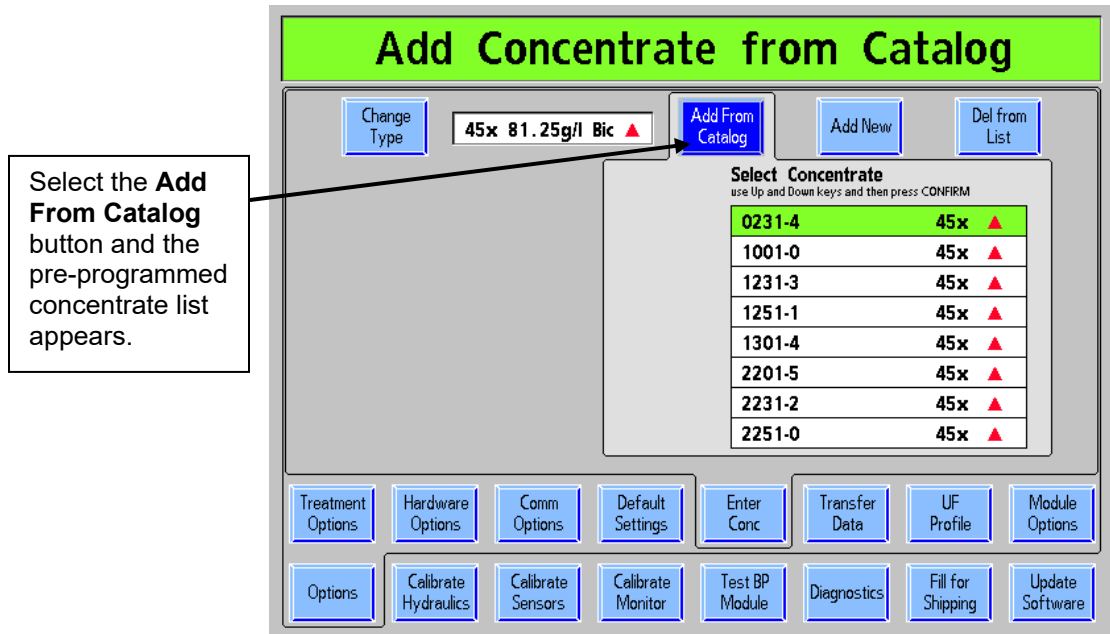

Figure 69 – Adding Concentrates from the Catalog

To add a new concentrate that is not in the catalog:

Select the **Add New** button and press **CONFIRM**. If a dry concentrate is being used, set the **GranuFlo®** option to Yes (by pressing the **CONFIRM** key with the **GranuFlo®** toggle-button selected, then using the round left arrow key on the Navigation Keypad to select Yes and pressing **CONFIRM**). Modify all of the constituents to match the concentrate. Select the **Conc Name** button and then input the desired alphanumeric name. Use the number keys on the front panel for the numeric values and the letters on the screen for the alphabetic values. Press **CONFIRM** to confirm your changes. After all of the constituents are correctly entered and the name of the concentrate has been chosen, select the **Enter Conc** screen-button and press **CONFIRM** to verify that the concentrate was entered into the list (see Figure 70 – Adding new concentrates below).



Note: If the new concentrate is Acetate, determine the value for the Sodium (Na+), Potassium, (K+), Calcium (Ca++), Magnesium (Mg++), Acetate, and Dextrose. The calculated values are Chloride (Cl-) and Acetic Acid.

Note: When GranuFlo is selected, the acid concentrate's Acetate value of 8 mEq/l will be displayed as 4 mEq/l each in the Acetic Acid and Na Acetate fields.

Select the **Conc Name** button and enter the desired name.

Modify all constituents to match the concentrate label.

Figure 70 – Adding new concentrates

To add a Citrasate® concentrate that is not in the catalog:

On the “Add New Concentrate” screen, set the **Citrasate®** option to Yes (by pressing the **CONFIRM** key with the **Citrasate®** toggle-button selected, then using the round left arrow key on the Navigation Keypad to select Yes and pressing **CONFIRM**). The **Acetic Acid** button will change to a Citrate meter-box. Modify all of the constituents to match the concentrate. Select the **Conc Name** button and then input the desired alphanumeric name. Use the number keys on the front panel for the numeric values and the letters on the screen for the alphabetic values. Press **CONFIRM** to confirm your changes. After all of the constituents are correctly entered and the name of the concentrate has been chosen, select the **Enter Conc** screen-button and press **CONFIRM** to verify that the concentrate was entered into the list.



Note: If an acetate concentrate is selected, the **Citrasate®** option is not available.

In Dialysis Mode, the dialysate composition list will now show a meter box for ‘Citrate’:

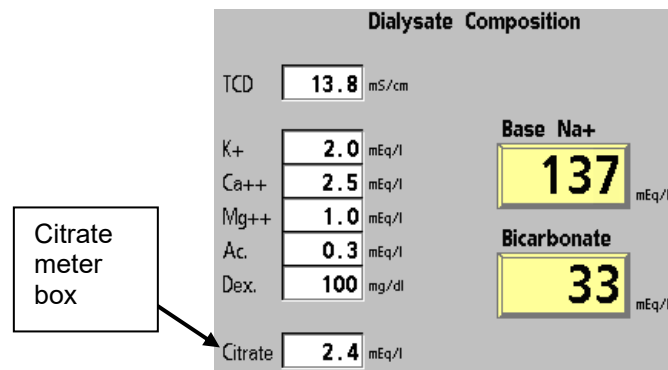

Figure 71 – Dialysate Composition with Citrate on the “Dialysate” screen

Creating Custom UF Profiles

Four custom UF profiles can be defined on the 2008K² hemodialysis machine.

Step 1

To enter a custom UF profile, turn the machine on into Service Mode by pressing the **CONFIRM** key when prompted during the power up sequence.

Step 2

Press the **Options** screen-key (the key directly below the screen-button) and then press the round right arrow key on the Navigation Keypad until the **UF Profile** screen-button is selected. Press the **CONFIRM** key to view the “UF Profile” screen. The four UF Profiles that can be modified will be displayed on the left side of the screen numbered from 5 – 8.

Step 3

Using the Navigation Keypad, select the desired profile to modify and press **CONFIRM**. It will then be enlarged with each of the 12 segments displayed in small edit boxes below the profile.

Step 4

One by one, select the yellow numbered button below each of the 12 segments with the Navigation Keypad. Enter any number from 0 to 100 using the numeric keypad or **+/-** keys. Press **CONFIRM** when done.

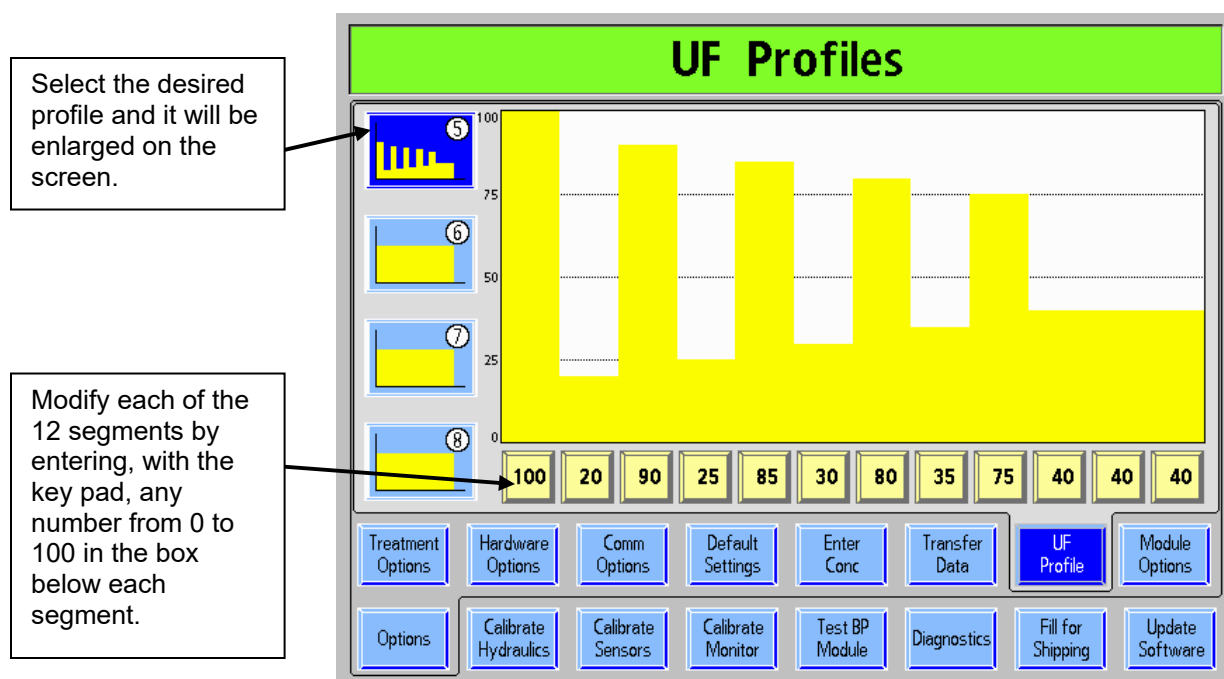

Figure 72 – Creating Custom UF Profiles



Auto Flow and Idle Mode

Using Auto Flow

With Auto Flow selected, the dialysate flow is proportional to the blood flow rate. As the blood flow rate increases, the dialysate flow rate will increase also. The dialysate flow will only adjust within the range of 300 or 500 (depending on a Service Mode selection) to 800 ml/min. During a treatment (blood sensed) with Auto Flow selected, the dialysate flow rate will only change when the user changes the blood flow rate (water alarms and alarms that stop the blood pump will not change the dialysate flow).

See “Auto Flow Service Mode Selections,” on page 216 to set the Auto Flow option in Service Mode.

Table 36 – Dialysate Flow Auto Flow Features

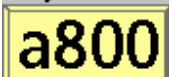
Feature	Function
Dialysate Flow  Dialysate Flow 	<p>The prescribed dialysate flow rate, in ml/min, is entered on the “Home” screen. The rate, displayed in ml/min, can be entered from 0 to 800 in increments of 100. “Auto Dialysate Flow” may be selected by scrolling up past 800. “1.5x or 2x” may be displayed, depending on the setup in Service Mode. If one of the automatic selections is selected, the dialysate flow rate will be set to approximately either 1.5 times or 2 times the blood flow rate. The dialysate flow rate will then be between 300 (or 500 depending on the setup in Service Mode) and 800 ml/min, in 100 ml/min increments.</p> <p>Idle Mode also affects the dialysate flow rate of the machine when turned on or after a Rinse or Disinfection program.</p> <p> Warning! Setting the dialysate flow to a rate that is too low can adversely affect dialyzer clearance and reduce treatment efficacy. If Auto Flow selects a flow rate below that prescribed, the dialysate flow may be manually set to the desired value.</p>
Dialysate Flow 	<p>After the flow rate selection has been confirmed, the Dialysate Flow button displays the current dialysate flow rate. If “Auto Flow” is active, the flow rate will be indicated with the letter “a” preceding the flow rate as shown to the left.</p>

To set Auto Flow, select the **Dialysate Flow** button with the Navigation Keypad.

Use the **+** key to raise the value past 800. Depending on the Service Mode Auto Flow Selection, the button will display either 1.5x or 2x.

Press the **CONFIRM** key to save the change. The Auto Flow rate will have an 'a' preceding the value. Auto Flow will begin in about 30 seconds

Note: To stop Auto Flow, select the **Dialysate Flow** button and scroll down to the desired flow rate and press **CONFIRM**.

Figure 73 – Setting the Default Dialysate Flow

Depending on Service Mode selections, the operator may have a choice of 1.5x and/or 2x for the dialysate flow rate. A selection of 1.5x is appropriate for Optiflux dialyzers that have excellent distribution of flow in the dialysate compartment. Other types of dialyzers should probably be set at 2x. See the blood flow rate table on page 227 for information regarding the actual dialysate flow relative to the blood flow.



Warning! When the dialyzer is connected during setup, be sure that the dialysate flow rate is at least the minimum required rate.



Note: Dialysate flow changes are generally delayed about 30 seconds after a change in the blood pump rate to prevent unnecessary flow adjustments during priming and to allow the machine to stabilize before determining the new dialysate flow rate.



Note: With Auto Flow, even though the dialysate flow is expressed as a multiple of the blood flow rate, the dialysate flow is not exactly the calculated multiple of the blood flow. The dialysate flow changes in increments of 100 ml/min only. In order to be conservative with lower dialysate flow rates, each transition point to the next higher dialysate flow rate is somewhat earlier than one would calculate. See the table on page 227 for more details.

Auto Flow Service Mode Selections

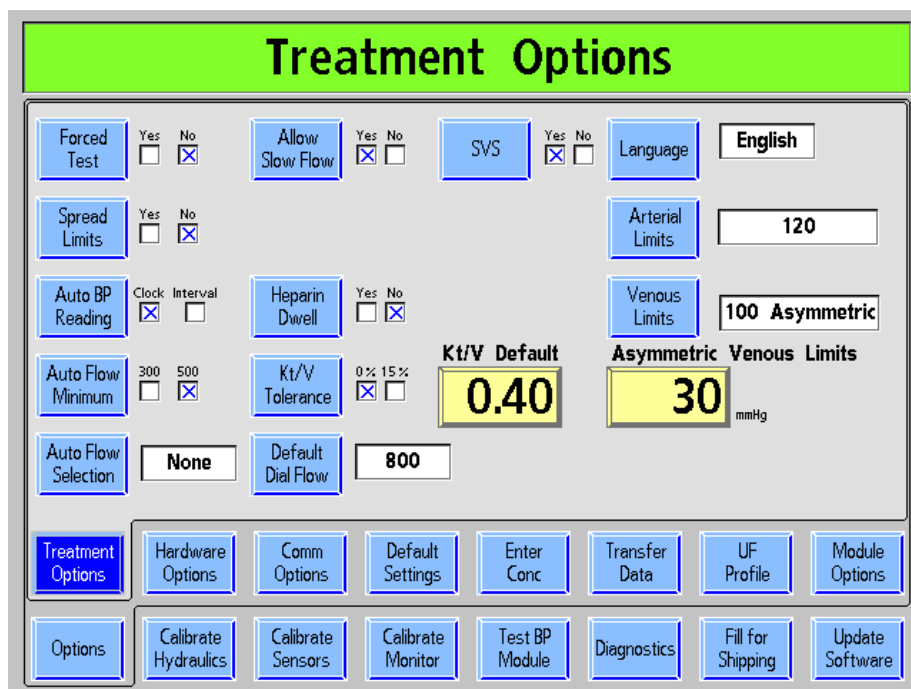
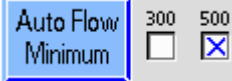
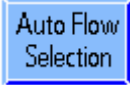
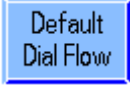

Figure 74 – Auto Flow Service Mode Screen

Table 37 – Auto Flow and Idle Mode Features

Button	Description
	<p>The Auto Flow Minimum option selects the dialysate flow rate during dialysis when Auto Flow is selected:</p> <p>300 – 800 ml/min or</p> <p>500 – 800 ml/min (default selection)</p>
	<p>There are four available choices for Auto Flow in dialysis:</p> <p>Both—The operator can scroll to either 1.5x or 2x (default selection).</p> <p>1.5X—The operator only has a choice of 1.5x (plus the normal flow rates).</p> <p>2.0X—The operator only has a choice of 2x (plus the normal flow rates).</p> <p>None—The operator cannot choose any Auto Flow options.</p> <p>See the blood flow rate table on page 227 for more information.</p>
	<p>The Default Dial Flow button opens as a pull down menu used to set the default dialysate flow rate the machine runs after exiting Idle Mode, 500, 600, 700 or 800 ml/min (if 1.5x or 2x Auto Flow was not set). The user is then free to set the prescription.</p>

Idle Mode

Regardless of Auto Flow selections, the machine will take control of the dialysate flow during idle periods.

During idle periods, the machine will run dialysate flow at 300 ml/min provided the following conditions are met:

- A long power down, rinse, disinfect, or self test has just occurred
- No new dialysate flow rate has been set
- Conductivity is within limits
- The blood pump is off
- The Tx Clock has not been started

or

- Tx has ended (i.e., RTD counted to 0, blood not sensed, and blood pump is off)

Idle Flow is cancelled when the blood pump is turned on, a new dialysate flow rate is selected, or the treatment has started (i.e., RTD > 0 or blood is sensed). The dialysate flow will then be the selected default dialysate flow (see page 216) or what the user has entered on the “Home” screen.

Auto Heat Disinfect

The Auto Heat Disinfect option is a special feature* that allows the user to program the 2008K² hemodialysis machine to automatically run a heat disinfection program according to a schedule. In the “Options: Default Settings” screen the user may select a start time (Start Prg) and any day(s) of the week toggle-button(s).

This program affects only the start time of the Heat Disinfect, all other settings function as usual. With the machine on and set up for rinse, the Heat Disinfect program will run at the selected time(s).



Note: If another rinse is running when the Auto Heat Disinfect is set to run, the Auto Heat Disinfect will start after the first rinse completes.

Setting Auto Heat Disinfect Times

1. Go to Service Mode and select the “Options: Default Settings” screen (see below).

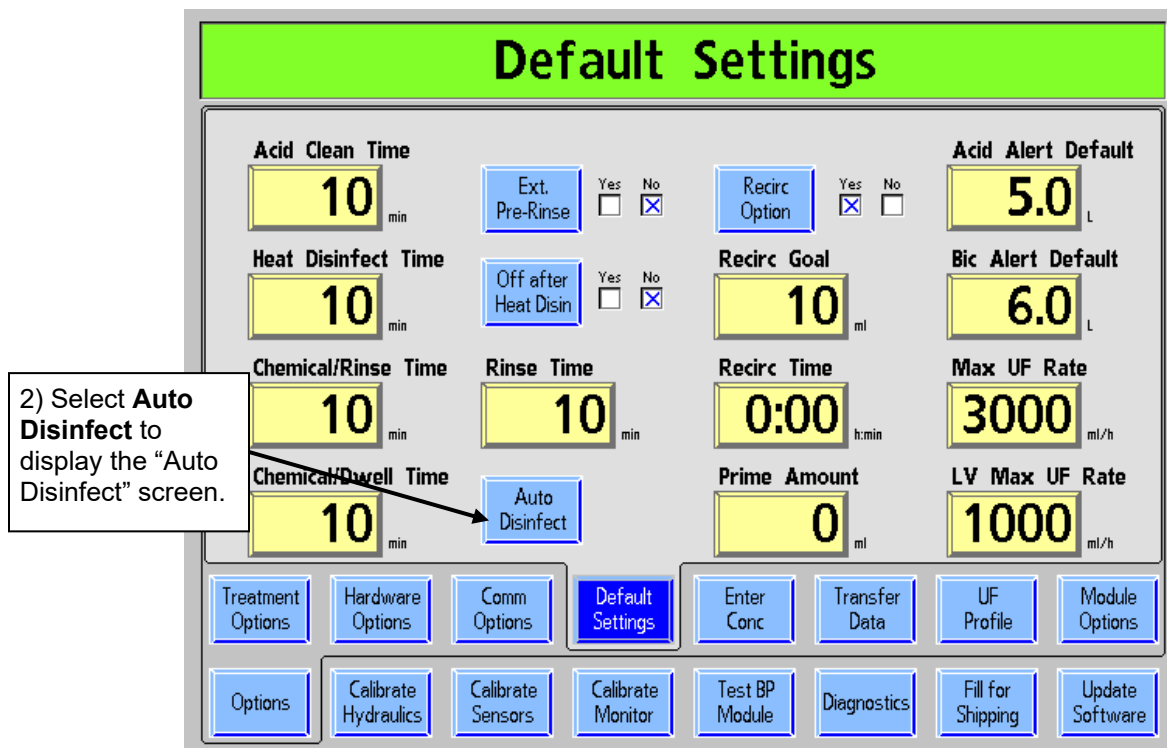

Figure 75 – Service Mode: Options: Default Settings Screen

* The Auto Heat Disinfection feature is only available with kit P/N 190679. Contact the Fresenius Medical Care Spare Parts department or your sales representative for more information and pricing.

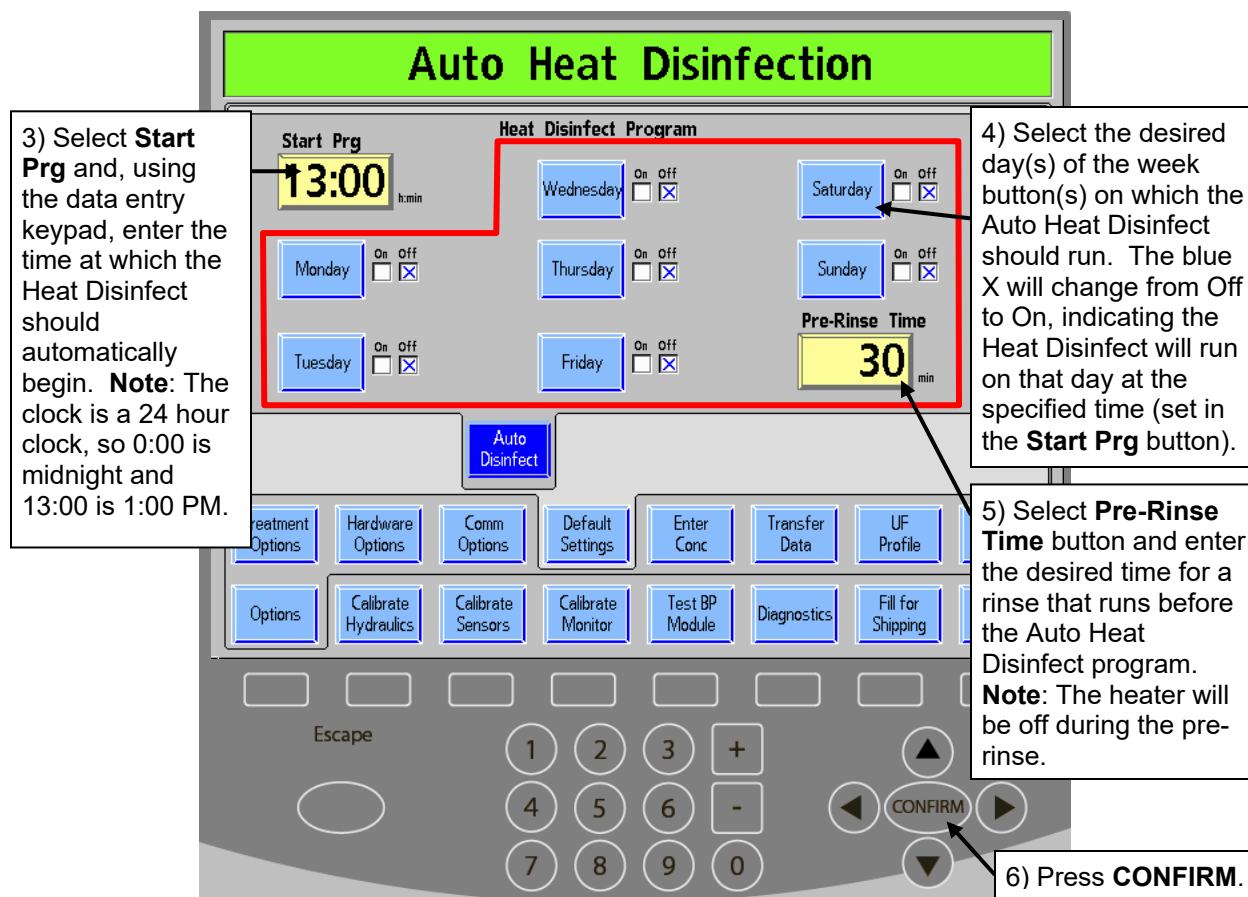

Figure 76 – Setting Auto Heat Disinfect Schedule

7. Exit Service Mode and go to the “Select Program” screen after powering on.
8. Ensure that both dialysate lines are on the shunt.
9. Place both concentrate connectors in their respective ports. The Auto Heat Disinfect program will automatically run at the selected time(s).



Warning: Do not run a Rinse program at the end of the treatment day before allowing the Auto Heat Disinfect program to run. Doing so will not allow the RO (permeate or product) water to flow into the machine during the Auto Heat Disinfect program. Leave the machine on in the “Select Program” screen with the concentrate connectors in their ports at the end of the treatment day. The Heat Disinfect will then run automatically.



Note: The dialysate lines must be on the shunt and both concentrate connectors must be in their respective ports for the Auto Heat Disinfect program to run.

Note: At the end of the treatment day, perform an Acid Clean and leave the machine on the "Select Program" screen.

Available Software & Hardware Treatment Options and Default Settings

The following options are available on the 2008K² hemodialysis machine and selected from the Service Mode in either the “Treatment Options” screen or “Hardware Options” screen.

Forced Test

Upon power up and entering dialysis (except after a power failure or short power down), the machine will be in Standby. In Standby, the blood pump doesn't run (except for Prime and Level Adjust). The ultrafiltration and Sodium Variation System cannot be turned on. “STANDBY FOR TEST” is displayed as a low priority message.

The test sequence will automatically start 30 seconds after the test criteria have been met. Standby ends with the initiation of the test (whether by the operator or automatically).

Spread Limits

When activated and no blood leak alarm exists, the **Override** key can be used to spread the arterial and venous alarm limits by 300 mmHg for 30 seconds. The TMP alarm limits will completely open. After 30 seconds the limits will reset around the current pressure readings.

Auto Blood Pressure Reading

This option can be used to select the method for determining when to take a blood pressure reading. With “Interval” selected, the readings occur at the time interval selected. With “Clock Time” selected, the blood pressure is taken at specified times (e.g. every half hour on the hour and half hour).

Auto Heat Disinfect

In the “Options: Default Settings” screen the user may select a start time (Start Prg), days of the week toggle-buttons, and a pre-rinse time to automatically run a Heat Disinfect program. This program affects only the start time of the Heat Disinfect, all other settings function as usual. With the machine on and set up for rinse, the Heat Disinfect program will run at the selected time(s).

Note: Requires special activation for this feature, contact Fresenius Medical Care Spare Parts department or your sales representative for more information and pricing.

Off After Heat Disin

Set in the “Options: Default Settings” screen, the user may choose to automatically power down the machine after an Auto Heat Disinfect program is run.

Allow Slow Flow

The Allow Slow Flow option allows the machine to run dialysate flows of 100, 150, or 200 ml/min. SLED Mode requires that this option be set to 'Yes'. The Allow Slow Flow option requires a temperature calibration. Please refer to the 2008K² Hemodialysis System Calibration Procedures manual (P/N 508137).

SVS

The SVS (Sodium Variation System) feature may be enabled or disabled.

Heparin Dwell

The Heparin Dwell option displays the Heparin Dwell button on the "Heparin" screen. The button acts as a five minute timer; after a manual heparin bolus is administered and the operator selects and confirms the Heparin Dwell button, causing the optional 'Traffic Light Status Beacon' on the IV pole to flash yellow for five minutes while the heparin is dwelling.

Kt/V Graph Tolerance

Either a 0% or a 15% tolerance from the target Kt/V is selectable in Service Mode. If 15% is selected and the projected Kt/V is less than 85% of the target, the operator will be alerted. If 0% is selected and the projected Kt/V is less than 100% of the target, the operator will be alerted.

Kt/V Default

The default Kt/V (target or minimum value) is selectable in Service Mode.

Language

The operating screens may be setup so that they are in either French (Canada), Spanish (Mexico), or English (USA). Service Mode is always in English.

Arterial and Venous Pressure Limits

The width of the venous and arterial pressure windows are set by these options. The windows may be set to a fixed width for all treatments or the user may be allowed to set the limits for each treatment in the Test & Options screen. The arterial window may be set to a total width of 120, 160, or 200 mmHg. The venous window may be set to for 100 asymmetric, or 120, 160, 200 mmHg width. If 100 asymmetric limits are chosen, the lower venous limit will tighten to the selected value after a short time delay. This value is selected with the "100 Asymmetric Limits" parameter entry button in Service Mode. The choices are 20, 25, 30, 35 mmHg. The lowest value that does not cause frequent nuisance alarms should be chosen.

Online PHT

The online pressure holding test (PHT) is enabled or disabled with this button. Normally, the PHT should be set to “Yes”.

Arterial Chamber

This option is used to define whether the arterial chamber is pre-pump or post-pump. The range of the display is different depending on the location of the chamber.

Audible Alarms

This option may be set so that audible alarms do not occur in certain situations. With “Yes” set, audible alarms will occur in any alarm situation when either blood is sensed in the venous bloodline or the lines are off the shunt. If “No” is selected, audible alarms only occur when blood is sensed. **Note:** Regardless of this setting, the machine responses, such as bypass or blood pump and venous clamp operation are unaffected.

T and C Mode

This is for manufacturing operations only and should never be selected by the facility.

0 Arterial Limit

With this option set to yes, the upper arterial limit cannot be above 0 (with pre-pump arterial monitoring only) when blood is sensed unless the spreading limits function is active.

Beacon (Traffic Light)

There are four possible selections for this option: Alarm, FDS08, OLC, Status:

- With “Alarm” selected, the red light acts the same as the audible alarm. The yellow light illuminates when warnings occur. The green light is illuminated when there are no alarms or warnings.
- With “FDS08” selected, the red light acts the same as the audible alarm. The yellow light is based on a flag sent from FDS08 that indicates the machine is set outside of established dialysis order limits. The green light illuminates when the blood volume processed has been achieved as required by the FDS08 dialysis order.
- With “OLC” selected, the red light acts the same as the audible alarm. The yellow light is illuminated when the projected Kt/V is less than 100% of the target Kt/V (depending on selected Service Mode option). The Green light is illuminated if there are no alarms, and the necessary OLC parameters have been set (Volume, Target Kt/V, and OLC enabled) and the Kt/V is projected to be at least 100% of target (depending on selected Service Mode option).
- With “Status” selected, the traffic lights act the same as the Red/Yellow/Green indicator lights on the machine.

DIASAFE Plus Filter

This option defines whether or not a Diasafe Plus filter is present in the machine. As some of the timing of various functions is dependent on the volume in the filter, this option must be set properly.

HE Leak Test

Setting this option to 'Yes' will run a four minute pressure holding test on the Heat Exchanger after the Chemical/Rinse program's 45 second pre-rinse.

Clean, Rinse, and Disinfect times

The times for these various programs may be set in the Service Mode.

Extended Pre-Rinse

With this option set to yes, the pre-rinse time for heat disinfect is increased to 20 minutes with reduced flow and higher fluid temperature through the drain line.

Recirculate Option

If active, a RECIRC GOAL and TIME can be selected. When Recirculation is initiated, the preselected goal and time with the calculated rate will automatically display on the "Dialysis" screen and start ultrafiltration.

Prime Amount

A desired prime volume from 100–1000 ml can be selected. This allows Prime to continue until the selected volume has been delivered (measured by the blood pump speed).

Acid and Bic Alert Default

The operator may use the option to sound an alert when the concentrate jugs are low. This is setup in the "Dialysate" screen. These default values are set using these parameter entry buttons.

Max. UF Rate

This selection limits the maximum UF rate for a standard patient's treatment. The choices are 1000, 2000, 3000, 4000 ml/h.

LV Max UF Rate

This selection limits the Low Volume maximum UF rate for a low volume patient's treatment. The choices are 500, 600, 700, 800, 900, and 1000 ml/h.

Default Dial Flow

This selection sets the default dialysate flow rate that appears on the “Home” screen. The choices are 500, 600, 700, and 800 ml/min.

Other Options

There are other options on these screens that may not be specifically described here. Generally, these are setup options that are based upon the presence or absence of other modules or hardware.

Options which require a “key” for activation

Certain options are extra cost or limited in availability and must be activated by use of a special code stored on the functional board. Examples of this sort of feature include OLC and SLED. Upon purchase of such a feature, use the following procedure to activate it on the machine.



Caution: This procedure should be performed by a qualified individual. Be sure to follow electrostatic discharge (ESD) procedures when removing the board and replacing the EEPROM chips on the board.

- To transfer the option, the EEPROM “hardware key” is placed in IC20 on the functional board in place of the calibration EEPROM. Save the calibration EEPROM as it must be returned to the same machine. Be sure to match the notch on the EEPROM with the socket.
- Return the functional board to the machine and turn on the power.
- Upon power up the functional board reads the contents of the memory from the EEPROM key.
- The message “New feature loaded. Power off. Replace eeprom.” is displayed.
- Turn off power, replace the EEPROM “hardware key” with the calibration EEPROM, and turn the power back on.



Note: The key may be used only once. If the key is reused, the machine locks up and displays the message “Eeprom already used. Power off. Replace eeprom”.

Equipment Storage and Maintenance

Follow the storage and maintenance procedures for dialysis equipment used for Intermittent Hemodialysis (IHD) in the ICU setting.



Warning! Possible explosion hazard if used in the presence of flammable anesthetics.

Storage Location

If the dialysis unit is incorporated in the hospital, the equipment should be stored so that it will not be damaged. The maintenance of the equipment is normally part of the duty of the dialysis service technician. Depending on the disinfectant and the storage time, frequent flushing of the equipment is necessary.

If it is more convenient to store the equipment close to the ICU, the dedicated storage space should have an access to tap water, power and a drain. The room should be well vented, if disinfectant is used.

Storage Preparation

Before storing the 2008K² hemodialysis machine, the hydraulics should be disinfected. It is also necessary to wipe the external parts of the machine with a surface cleaner. Frequency of disinfection and length of the dwell time depend on the disinfectant and shall be determined by acceptable culture result. The following table lists commonly used procedures to store equipment and then return it from storage. Validate your own procedure according to the facility's policy. After prolonged storage, use a bleach disinfectant prior to patient use.

Table 38 – Disinfectant Information

Disinfectant	Program	Dwell time	Retest and Repeat
Formaldehyde	Fill Hydraulic (Service Mode)	Unlimited	3 – 4 weeks
Bleach	Chemical Disinfection program	Only for time of disinfection program	24 hours
Renalin	Chemical Disinfection program	Only for time of disinfection program	24 hours
Heat	Heat Disinfection program	Recirculate and shut machine off	24 hours

Machine Specifications

Dimensions

Floor space	Approximately 54 cm wide by 63 cm deep
Height	133 cm
Total weight	Approximately 73 kg
Operating conditions	60 – 100 °F (15.5 – 38 °C)
Storage conditions	Room temp, 6 months, Do not freeze

Electrical

Power Supply—Main	Single phase AC 117 V $\pm 10\%$ 60 Hz ± 3 Hz must be connected to a circuit which is equipped with a hospital grade receptacle and is protected by circuit breaker and ground fault interrupter (GFI). Resistance from chassis to ground must be < 0.2 ohm.
Power Consumption	Does not exceed 12.5 amps
Fuses	6.3 amp medium blow fuse, 2 each 16 amp double pole rocker switch circuit breaker for heater
External Connections	A. Alarm input B. External alarm light or traffic light beacon C. Isolated RS232 and leakage current isolation per UL 60601-1 between the machine and external computer
Heat Dissipation to Room	600 to 700 BTU/hr
Electromagnetic compatibility	See EMC Declaration on page 235

Electrical safety (UL 60601-1)

Protection against electric shock	Type: Safety class I Degree: Type B Type CF: Only BPM Blood Pressure Cuff
Leakage currents	According to UL 60601-1

Water

Back Flow Prevention	Integral back flow prevention provided by external vent to atmosphere in water inlet circuit.
Water Pressure	Min 20 psi; max 105 psi
Water Temperature	Min 10 °C; max 25 °C

Water Quality	<p>Current national (U.S.) Standards for the Quality of Water:</p> <ul style="list-style-type: none"> • ANSI/AAMI 13959:2014, Water for hemodialysis and related therapies • ANSI/AAMI 26722:2014, Water treatment equipment for hemodialysis applications and related therapies <p>Other related standards include:</p> <ul style="list-style-type: none"> • ANSI/AAMI RD62:2006, Water treatment equipment for hemodialysis applications and related therapies 																								
Drain	<p>3 feet maximum height. Must comply with local codes and must maintain a free fall air gap between drain hose and building drain.</p> <p>3 meters (approximately 10 feet) maximum drain hose length</p>																								
Rinsing	<p>Temperature 37 °C. Flow rate 620 ml/min. Time between 10 and 60 minutes (internally selectable)</p>																								
Dialysate																									
Dialysate Quality	<p>Current national (U.S.) Standards for the Quality of Dialysis Fluid:</p> <ul style="list-style-type: none"> • ANSI/AAMI 11663:2014, Quality of dialysis fluid for hemodialysis and related therapies • ANSI/AAMI 23500:2014, Guidance for the preparation and quality management of fluids for hemodialysis and related therapies <p>Other related standards include:</p> <ul style="list-style-type: none"> • ANSI/AAMI RD52:2004, Dialysate for hemodialysis 																								
Dialysate Flow Adjustment Range	<p>Dialysate on/off key</p> <p>Accuracy: $\pm 5\%$</p> <p>Dialysis Mode: Sequential (0)/100*/150*/200*/300/400/500/600/700/800 ml/min, selectable on the "Home" screen; Additionally: 1.5X or 2.0X dialysate flow rate based on the Blood Pump rate (Qb):</p> <table border="1" style="width: 100%; border-collapse: collapse;"> <thead> <tr> <th style="text-align: left;"><u>Qb w/1.5X selected</u></th> <th style="text-align: left;"><u>Qb w/2.0X selected</u></th> <th style="text-align: left;"><u>Qd</u></th> </tr> </thead> <tbody> <tr> <td>0 – 165[†]</td> <td>0 – 150[†]</td> <td>300</td> </tr> <tr> <td>166 – 215[†]</td> <td>151 – 215[†]</td> <td>400</td> </tr> <tr> <td>216 – 315[†]</td> <td>216 – 265[†]</td> <td>500</td> </tr> <tr> <td>315 and below[‡]</td> <td>265 and below[‡]</td> <td>500</td> </tr> <tr> <td>316 – 415</td> <td>266 – 315</td> <td>600</td> </tr> <tr> <td>416 – 480</td> <td>316 – 365</td> <td>700</td> </tr> <tr> <td>481 and above</td> <td>366 and above</td> <td>800</td> </tr> </tbody> </table> <p>Note: All flow rates are approximate. Dialysate flow will not adjust unless the blood pump is adjusted at least 15 – 20 ml/min.</p> <p>SLED Mode*: 100/150/200/300 ml/min</p> <p>* Requires 'Allow Slow Flow' Service Mode option</p> <p>[†] (if Auto Flow Minimum 300 Qd is set in Service Mode)</p> <p>[‡] (if Auto Flow Minimum 500 Qd is set in Service Mode)</p>	<u>Qb w/1.5X selected</u>	<u>Qb w/2.0X selected</u>	<u>Qd</u>	0 – 165 [†]	0 – 150 [†]	300	166 – 215 [†]	151 – 215 [†]	400	216 – 315 [†]	216 – 265 [†]	500	315 and below [‡]	265 and below [‡]	500	316 – 415	266 – 315	600	416 – 480	316 – 365	700	481 and above	366 and above	800
<u>Qb w/1.5X selected</u>	<u>Qb w/2.0X selected</u>	<u>Qd</u>																							
0 – 165 [†]	0 – 150 [†]	300																							
166 – 215 [†]	151 – 215 [†]	400																							
216 – 315 [†]	216 – 265 [†]	500																							
315 and below [‡]	265 and below [‡]	500																							
316 – 415	266 – 315	600																							
416 – 480	316 – 365	700																							
481 and above	366 and above	800																							
Partial Dialysate Collection	<p>From Drain line, intermittent collection using a 3 Liter PD drain bag as a collection device with a Safe-Lock connector (optional).</p>																								

Concentrate Supply

Concentrate Quality Current national (U.S.) Standards for the Quality of Concentrates: ANSI/ AAMI 13958:2014, Concentrates for hemodialysis and related therapies

Concentrate Pressure Max suction height 3 feet; Max supplied pressure 2 psi

Proportional Mixing System

Acid Volumetric, selectable:
1:34
1:44
1:35.83
1:35.1
Note: Citrasate® is for use with 1:44 concentrates only.

Acetate 1:34

Adjustment Range 130 to 155 mEq/L Na⁺

Bicarbonate Volumetric, selected with associated acid ratio:
1:27.46
1:19.13
1:25.16
1:27.6

Adjustment Range 20 to 40 mEq/L Bicarbonate (post-reaction, after mixing with the acid and purified water).

Monitoring Conductivity Average Accuracy: ± 1.5%
Method: Temperature compensated electronic conductivity meter with adjustable alarm limits.
Temperature compensated conductivity display with automatically set alarm windows ± 0.5 mS/cm around calculated conductivity. User can adjust an additional ±0.5 mS/cm within this range. Conductivity is based on the concentrates' compositional data entered in the Dialysate screen at the standard temperature of 25 °C.

Range of Display 10.0 to 17.0 mS/cm. At 25 °C. Alarm limits will not go below 12.5 or above 16.0 mS/cm.

Dialysate Heating 35 to 39 °C Accuracy: ± 0.3 °C (measuring accuracy under calibration conditions for a dialysate flow of 500 ml/min)

Nominal Value of Temperature (selectable in 0.1 °C steps)

Temperature Display Range 35 to 39 °C with alarm limit window automatically adjusted to 2 °C above and below set point. Alarm window will not go below 30° or above 41 °C. Heater 1.3 kW, electronically controlled.

Heat Disinfection

Temperature 83 ± 8 °C at NTC 3

Flow Rate 600 ml/min.
Pre-rinse either 7 min @ 600 ml/min or 20 min @ 300 ml/min (user selectable). 10 min @ 600 ml/min for DIASAFE PLUS equipped machines.

Time Between 10 and 60 minutes (internally selectable)

Auto Heat Disinfect Pre-rinse Time Between 15 and 30 minutes (user selectable) @ 600 ml/min (standard) or 350 ml/min (extended pre-rinse).
Note: Heater is off during pre-rinse.

Auto Heat Disinfect Pressure 25 psi < pressure < 90 psi
Note: Silicon inlet/drain tubing set #M38512 must be used with this option.

Chemical Disinfection

Temperature 37 °C (set point applicable)

Flow Rate 620 ml/min

Time Between 10 and 60 minutes (internally selectable)

Blood Pump

Display of flow rate 8 mm blood line: 20 – 600 ml/min (not available with the Low Volume option set)
6.35 (displayed as 6.4) mm blood line: 20 – 465 ml/min
4.8 mm blood line: 10 – 274 ml/min
2.6 mm blood line: 6 – 86 ml/min

Accuracy: $\pm 10\%$ tested at -200 mmHg

Internal diameter of pump segment 2.6 to 10 mm (0.1" to 0.4")

Tube length 32 cm minimum (12-5/8")

Min. pump segment wall thickness 1.26 mm

Durometer 80 shore A nominal

Level adjust Up only

Power outage use The pump can be manually operated with a hand crank.

Single Needle System

Two Pump Procedure With two blood pumps, pressure control system with alternating blood pumps. Alarm after 15 or 30 seconds without an alternation of the pumps.

Heparin Pump

Administration Rate 0 to 9.9 ml/hr

Accuracy: $\pm 5\%$

Monitoring Monitoring end of stroke

Bolus From 0.1 to 9.9 ml volume

Type of Syringe

The following disposable syringes have been validated for use on the machine heparin pump. The dimensions tested are provided by the syringe manufacturers and based on their specifications.

Machine Display	Vendor Syringe Name	Vendor Code
BD Black 10 ml	BD 10ml Syringe Only	301997
	BD 10ml Safety-Lok	305564
	BD 10ml Luer-Lok with Needle	309642
	BD 10ml Syringe & Needle Combo (WWD-Mexico)	309642-20
	BD 10ml Luer-Lok	309604
	10 mL BD Luer-Lok with 20 G x 1 in. needle	309644
	Braun 10 ml	B. Braun 10ml Injekt Luer-Lock
B. Braun 10ml Luer-Lock		4617100V-02
Monoject 10 ml	Covidien/Kendall Monoject 12 ml Luer-Lock (relabeled as 10 ml)	1181200777T
Monoject 12 ml	Covidien/Kendall Monoject 12 cc Luer Lock	1181200777
Nipro 10 ml	Nipro 10cc Luer-Lock without needle	JD+10L-WEI
	Nipro 10cc Luer-Lock	JD+10L2025-WEI
SOL-Care 10 ml	Sol-Care 10ml Luer-Lock Safety Syringe without Needle	120008IM
	SOL-M 10ml Luer Lock Syringe without Needle	180010
Terumo 10 ml	Terumo 10cc Luer Lock Tip Syringe without Needle	SS-10L

Monitoring Elements: Blood Circuit

Arterial Pressure Monitor

Standard: -300 to +500 mmHg with 3 automatically set time-delayed alarm window limit values (± 60 , ± 80 , and ± 100 mmHg of actual pressure (Single Needle ± 80 mmHg).
 Low Volume: -260 to +100 mmHg (Pre Blood Pump) or -60 to +300 mmHg (Post Blood Pump) with 3 automatically set alarm limit window widths (± 40 , ± 60 , and ± 80) mmHg centered around set pressure.

Venous Pressure Monitor

Standard: -80 to +500 mmHg with 3 fixed window limit values of ± 60 , ± 80 , and ± 100 mmHg of actual pressure. There is also an asymmetric range initially set to ± 80 mmHg which increases the lower limit after 60 seconds (Single Needle ± 80 mmHg).
 Low Volume: -60 to +300 mmHg with 3 fixed window limit values of ± 40 , ± 60 , and ± 80 mmHg of set pressure. (Single Needle ± 80 mmHg).

Accuracy

± 20 mmHg or $\pm 10\%$ of indicated reading, whichever is greater

TMP Monitor	+60 to -520 mmHg with automatically set time delayed window limit values of ± 60 (conventional dialysis) and ± 40 mmHg (high flux dialysis). Compensation for upward drift.
Level detector	Ultrasonic impulses detect fluid level in the drip chamber.
Optical Sensor	Optical transmission used to detect opaque or non-opaque presence in the blood tubing.
Clamp	Closes with any blood alarm
Level Adjust	Allows the level in the drip chamber to rise to maintain the desired fluid level in the drip chamber
Blood Leak Detector	Two color light source transmitter / sensor with a resolution of: minor ≥ 0.35 ml/min of blood (hematocrit = 25%) alarm ≥ 0.45 ml/min of blood (hematocrit = 25%)
Ultrafiltration Control	
UF Pump Volume Accuracy	$\pm 1\%$ (for $P_{di} > -500$ mbar) where P_{di} = dialysate pressure on the inlet side of the dialyzer
Fluid Removal Rate from Patient	0 – 4000 ml/hr Dialysate flow rate at 100 ml/min: Accuracy (on total volume removed): $\pm(1\%$ UF rate + 18 ml/hr) Dialysate flow rate at 500 ml/min: Accuracy (on total volume removed): $\pm(1\%$ UF rate + 30 ml/hr) Dialysate flow rate at 800 ml/min: Accuracy (on total volume removed): $\pm(1\%$ UF rate + 48 ml/hr)
Adjustment Range of UF Rate	Volumetric Control, adjusted in 10 ml/hr increments. Standard Dialysis: 0-4000 ml/hr, SLED Mode: 0-1000 ml/hr, Low Volume: 0-1000 ml/hr. Standard Dialysis maximum rate (set in Service Mode) 1000, 2000, 3000, and 4000 ml/hr Low Volume maximum rate (set in Service Mode): 500, 600, 700, 800, 900, and 1000 ml/hr
UF Time	Digital Display (0-9:59 hrs.) Selectable in increments of 1 min.
UF Goal	Digital Display (0-9,990 ml). Selectable in increments of 10 ml.
UF Profiles	Eight UF profiles are available for the removal of fluid from the patient. Four are preset and four may be defined by the user.
Remaining Time of Dialysis (RTD)	0-9:59 hours auto transfer from UF time, counting down in 1-minute increments. Can adjust manually.
UF Removed Display	Digital display max 9,999 ml counting in 1 ml increments.
Additional Monitoring	Alarm in case of power failure. Alarm in case of water shortage.

Functional Options

Online Clearance(Optional)	Dialysate Flow rate: 300 – 800 ml/min # of Tests: 1 – 6 during each treatment
Access Flow (Qa) (Optional, requires OLC)	Minimum Qa: Will not determine the Qa if less than the blood pump speed. Maximum Qa: 2000 ml/min
Sodium Variation System (SVS)	A means for temporarily increasing the sodium concentration at the beginning of dialysis for patient comfort.
Sodium Variation Profiles	Three preset profiles (step, linear, and exponential) for increasing, then decreasing the sodium concentration in dialysate.
Blood Temperature Monitor (BTM) (Optional)	A means of temperature control for the patient and for evaluating adequacy of access flow by measuring temperature changes in the arterial and venous lines after temporary excursions in the dialysate temperature.
Blood Volume Monitor (BVM) (Optional)	A module that measures the relative blood volume (hematocrit) as a means of determining if the fluid refilling rate from the body to the blood is insufficient to support the selected ultrafiltration rate. A fast rate of decrease or steeper slope in the blood volume trend graph may signal an upcoming hypotensive event.
Diasafe Plus Filter	A means of filtering the dialysate to reduce bacteriological and endotoxin exposure
Auto Heat Disinfect	Allows the user to program the 2008K ² hemodialysis machine to automatically run a heat disinfection program according to a schedule.
Low Volume	This option lowers blood pressure cuff ranges, pressure monitoring ranges, UF rates, and blood flow rates, and it restricts the allowable blood pump segment sizes to less than 8 mm for patients weighing between 20 and 40 kg. Note: The Low Volume option is not available with P/N 370085 (SunTech brand) blood pressure modules. Contact Fresenius Medical Care Technical Support for information on ordering compatible blood pressure modules.
SLED (Sustained Low Efficiency Dialysis)	A type of hemodialysis treatment that consists of lower dialysate and blood flow rates for up to 12 hours: Dialysate flow rates of 100, 150, 200 and 300 ml/min Ultrafiltration rates of 10-1000 ml/hr Blood flow rates of 0-300 ml/min

User Interface

Language The operating screens may be set to either French (Canadian), Spanish (Mexico), or English (USA)

Blood Pressure Module

Technique Measures systolic, diastolic pressures, and heart rate (pulse rate) using oscillometric method. MAP measured.

Cuff Deflation Interactive computer controlled. Determination for standard patients requires approximately 25-30 seconds depending on starting point, heart rate and motion artifact.

Cuff Inflation Typically 5 - 10 seconds from 0-250 mmHg.

Interval Settings Interval times: 5 - 60 minutes in increments of 5 minutes

Clock Time: 5, 10, 15, 20, 30, 60 minutes

Performance Limits

	Low Volume* (20-40 kg)	Standard (>40 kg)
Cuff Pressure Range	0-210 mmHg	0-300 mmHg
Initial Cuff Inflation	120 mmHg or adjusted by host	180 mmHg or adjusted by host
Systolic Determination Range	60-220 mmHg	60-250 mmHg
MAP Determination Range	45-220 mmHg	45-220 mmHg
Diastolic Determination Range	40-200 mmHg	40-200 mmHg
Pulse Rate Determination Range	40-200 BPM	40-200 BPM
Cuff Inflation Rate	5 seconds	5 seconds
Determination Time Normal	Approx. 20 seconds	25-30 seconds
Overpressure Cut Off	210 mmHg	300 mmHg
Transducer Drift	Auto Zeroing	Auto Zeroing
Leakage Rate (Max)	3 mmHg/min in 3 minutes	3 mmHg/min in 3 minutes
Pressure Rate Offset	Auto Zeroing	Auto Zeroing

*The 'Low Volume' option is not available with P/N 370085 (SunTech brand) blood pressure modules. Contact Fresenius Medical Care Technical Support for information on ordering compatible blood pressure modules.

Alarm Preset Values

Internal alarm values preset to provide alarm limits in the event individual values are not entered

	Low Volume (20-40 kg)	Standard (>40 kg)
Systolic	160/80	200/90
MAP	120/60	120/70
Diastolic	100/40	110/50
Pulse	120/50	120/50
Inflation Pressure	Auto	Auto

Manufacturer's EMC Declaration

Guidance and manufacturer's declaration – electromagnetic emissions		
The 2008K ² hemodialysis machine is intended for use in the electromagnetic environment specified below. The customer or user of the 2008K ² hemodialysis machine should ensure it is used in such an environment.		
Emissions test	Compliance	Electromagnetic environment – guidance
RF Emissions CISPR 11	Group 1	The 2008K ² hemodialysis machine uses RF energy only for its internal functions. Therefore, its RF emissions are very low and are not likely to cause any interference in nearby electronic equipment.
RF Emissions CISPR 11	Class A	The 2008K ² hemodialysis machine is suitable for use in all establishments other than domestic, and those directly connected to the public low-voltage power supply network that supplies buildings used for domestic purposes.
Harmonic emissions IEC 61000-3-2	Not applicable	
Voltage fluctuations/ flicker emissions IEC 61000-3-3	Not applicable	

Guidance and manufacturer's declaration – electromagnetic immunity			
The 2008K ² hemodialysis machine is intended for use in the electromagnetic environment specified below. The customer or the user of the 2008K ² hemodialysis machine should assure that it is used in such an environment.			
Immunity test	IEC 60601 test level	Compliance level	Electromagnetic environment – guidance
Electrostatic discharge (ESD) IEC 61000-4-2	±8 kV contact ±15 kV air (Level 4)	±8 kV contact ±15 kV air (Level 4)	Can be used in a dry location (minimum 10% relative humidity)
Electrical fast transient/burst IEC 61000-4-4	±2 kV for power supply lines ±1 kV for input/output lines	±2 kV for power supply lines ±1 kV for input/output lines	Mains power quality should be that of a typical commercial and/or hospital environment.
Surge IEC 61000-4-5	±1 kV line(s) to line(s) ±2 kV line(s) to earth	±1 kV line(s) to line(s) ±2 kV line(s) to earth	Mains power quality should be that of a typical commercial or hospital environment.
Voltage Dips, short interruptions, and voltage variation on power supply input lines IEC 61000-4-11	<5 % U_T (>95 % dip in U_T) for 0.5 cycles 40 % U_T (60 % dip in U_T) for 5 cycles 70 % U_T (30 % dip in U_T) for 25 cycles <5 % U_T (>95 % dip in U_T) for 5 seconds	<5 % U_T (>95 % dip in U_T) for 0.5 cycles 40 % U_T (60 % dip in U_T) for 5 cycles 70 % U_T (30 % dip in U_T) for 25 cycles <5 % U_T (>95 % dip in U_T) for 5 seconds	Mains power quality should be that of a typical commercial or hospital environment. If the user of the 2008K ² hemodialysis machine requires continued operation during power mains interruptions, it is recommended that the 2008K ² hemodialysis machine be powered from an uninterruptible power supply or a battery.
Power-Frequency (50/60 Hz) magnetic field IEC 61000-4-8	3 A/m	3 A/m	Power frequency magnetic fields should be at levels characteristic of a typical location in a typical commercial or hospital environment.
NOTE U_T is the a.c. mains voltage prior to application of the test level.			

Guidance and manufacturer's declaration – electromagnetic immunity			
The 2008K ² hemodialysis machine is intended for use in the electromagnetic environment specified below. The customer or the user of the 2008K ² hemodialysis machine should assure that it is used in such an environment.			
Immunity test	IEC 60601 test level	Compliance level	Electromagnetic environment – guidance
Conducted RF IEC 61000-4-6	3 Vrms 150 kHz to 80 MHz	3 Vrms 150 kHz to 80 MHz	Portable and mobile RF communications equipment should be used no closer to any part of the 2008K ² hemodialysis machine, including cables, than the recommended separation distance calculated from the equation applicable to the frequency of the transmitter. If abnormal performance is observed such as TMP alarms or blood leak alarms, additional measures may be necessary, such as re-orienting or relocating the equipment. Recommended separation distance 1.2 √P
Radiated RF IEC 61000-4-3	3 V/m 80 MHz to 2.5 GHz	3 V/m 80 MHz to 2.5 GHz	1.2 √P 80 MHz to 800 MHz 2.3 √P 800 MHz to 2.5 GHz where P is the maximum output power rating of the transmitter in watts (W) according to the transmitter manufacturer and d is the recommended separation distance in meters (m). Field strengths from fixed RF transmitters, as determined by an electromagnetic site survey, ^a should be less than the compliance level in each frequency range. ^b Interference may occur in the vicinity of High Frequency Surgical Equipment (such as electrocautery devices) or other intentional radio frequency emitting equipment typically marked with the following symbol: 
NOTE 1 At 80 MHz and 800 MHz, the higher frequency range applies.			
NOTE 2 These guidelines may not apply in all situations. Electromagnetic propagation is affected by absorption and reflection from structures, objects, and people.			
^a Field strengths from fixed transmitters, such as base stations for radio (cellular/cordless) telephones and land mobile radios, amateur radio, AM and FM radio broadcast and TV broadcast cannot be predicted theoretically with accuracy. To assess the electromagnetic environment due to fixed RF transmitters, an electromagnetic site survey should be considered. If the measured field strength in the location in which the 2008K ² hemodialysis machine is used exceeds the applicable RF compliance level above, the 2008K ² hemodialysis machine should be observed to verify normal operation. If abnormal performance is observed, additional measures may be necessary, such as re-orienting or relocating the 2008K ² hemodialysis machine.			
^b Over the frequency range 150 kHz to 80 MHz, field strengths should be less than 3 V/m.			

Recommended separation distances between portable and mobile RF communications equipment and the 2008K ² hemodialysis machine			
The 2008K ² hemodialysis machine is intended for use in an electromagnetic environment in which radiated RF disturbances are controlled. The customer or the user of the 2008K ² hemodialysis machine can help prevent electromagnetic interference by maintaining a minimum distance between portable and mobile RF communications equipment (transmitters) and the 2008K ² hemodialysis machine as recommended below, according to the maximum output power of the communications equipment.			
Rated maximum output power of transmitter W	Separation distance according to frequency of transmitter M		
	150 kHz to 80 MHz d = 1.2 √P	80 MHz to 800 MHz d = 1.2 √P	800 MHz to 2.5 GHz d = 2.3 √P
0.01	0.12	0.12	0.23
0.1	0.38	0.38	0.73
1	1.2	1.2	2.3
10	3.8	3.8	7.3
100	12	12	23
For transmitters rated at a maximum output power not listed above, the recommended separation distance d in meters (m) can be estimated using the equation applicable to the frequency of the transmitter, where P is the maximum output power rating of the transmitter in watts (W) according to the transmitter manufacturer.			
NOTE 1 At 80 MHz and 800 MHz, the separation distance for the higher frequency range applies.			
NOTE 2 These guidelines may not apply in all situations. Electromagnetic propagation is affected by absorption and reflection from structures, objects, and people.			

APPENDIX B

Product Improvement Policy

The 2008K² hemodialysis machine was designed and built to comply with these product specifications. It is the intention of Fresenius USA, Inc. to improve products continuously, a process which may result in modifications to specifications or equipment produced in the future. Such product improvements shall not incur any obligation to make similar changes or improvements to equipment previously produced. These changes or improvements may or may not be applicable or usable with previously produced equipment. Where possible, improvements will be made available at reasonable prices. Any such improvement shall not be construed as corrections of any perceived deficiency.

Warranty

SALE of the machine or parts described or referenced herein is expressly conditioned upon the terms and conditions set forth below. Any additional or different terms or conditions set forth by the Purchaser to Fresenius USA, Inc., (herein called "the Company") shall not be effective or binding, and the terms set forth herein shall not be modified or amended, unless assented to in writing by an authorized official of the Company located in Waltham, Massachusetts.

LIMITED WARRANTY: The Company warrants to the Purchaser that the equipment delivered is free from defects in material or workmanship for the periods specified below, provided the equipment is used and maintained in accordance with the original manufacturer's operating instructions:

A. Mainframe chassis, and electronic components, lamps, etc. shall be warranted for one hundred and eighty (180) days from the date of installation or 2,000 metered hours, whichever occurs first.

B. Consumables are not covered under warranty. Consumables are those parts used in the performance of a Preventive Maintenance procedure as described in the Preventive Maintenance Procedures booklet. This includes routine calibrations, electronic and hydraulic, as outlined in the Preventive Maintenance checklist.

The Company will repair or replace, at its option, using new or reconditioned parts and/or assemblies, any parts subject to this warranty, which are proven defective in materials or workmanship. Such repair and replacement will be made without cost to the Purchaser, and the Company reserves the right to determine the location at which the repair or replacement will be accomplished. The Warranty does not apply to any equipment which is misused, abused, neglected, tampered with, damaged by accident, flood, fire, or other hazard, subjected to abnormal or unusual electrical or fluid stress, improperly installed or operated, or not maintained in accordance with the routine maintenance schedule set forth in the operating manual for the equipment. **Routine maintenance is not covered under warranty.** Modifications, alterations, installation and service by other than a FRESENIUS USA, Inc. authorized representative may void the warranty.

WARRANTIES APPLICABLE TO EQUIPMENT EXTEND ONLY TO THE PURCHASER, AND ARE NOT ASSIGNABLE OR TRANSFERABLE, AND SHALL NOT APPLY TO AUXILIARY EQUIPMENT, DISPOSABLE ACCESSORIES, OR LIGHT SOURCES. THE FOREGOING WARRANTY SHALL BE IN LIEU OF ANY OTHER WARRANTIES, EXPRESSED IMPLIED OR STATUTORY, RESPECTING THE EQUIPMENT OR ANY PARTS OR COMPONENTS THEREOF, AND THE COMPANY MAKES NO IMPLIED WARRANTY OF MERCHANTABILITY OR FITNESS FOR A PARTICULAR PURPOSE. THE PURCHASER'S SOLE AND EXCLUSIVE REMEDY IN CONTRACT, TORT, OR UNDER ANY OTHER THEORY AGAINST THE COMPANY RESPECTING THE EQUIPMENT AND ITS USE SHALL BE THE REPLACEMENT OR REPAIR OF THE EQUIPMENT AND ITS PARTS AS DESCRIBED ABOVE, AND NO OTHER REMEDY (INCLUDING, WITHOUT LIMITATION, CONSEQUENTIAL DAMAGES) SHALL BE AVAILABLE TO THE PURCHASER. The Company shall have no further obligation or liability with respect to the equipment or its sale, operation and use, and the Company neither assumes, nor authorizes the assumption of, any obligation or liability in connection with such equipment.

REFER ALL SERVICING AND INFORMATION REQUESTS TO:

Fresenius USA, Inc.

Attention: Service Department
4040 Nelson Avenue
Concord, CA 94520
Telephone: (800) 227-2572

Glossary

Air Lock—A condition caused by air entering the concentrate supply lines when not enough liquid concentrate is available. Air lock causes dialysate conductivity to be low.

Alarm Window—The allowable range without alarm for the arterial, venous, and transmembrane pressures, and the dialysate temperature and conductivity during treatment. Transition of either value outside the window will trigger an alarm. The conductivity alarm window is graphically represented in the Dialysate screen as the area located between the upper and lower alarm limits of the conductivity bar graph. The alarm window can be widened or narrowed, or shifted up or down within the hard limits. The temperature alarm window is ± 2 °C of the set temperature value within the temperature hard limits (30 °C to 41°C). The arterial and venous limit window width is also selectable. The position of the window is set automatically.

Asymmetric Limits—This is an option to select venous limits that are not symmetrical. If asymmetric limits are chosen, the lower venous limit will tighten to the selected value after a short time delay. The lower venous limit choices are 20, 25, 30, 35 mmHg. The lowest value that does not cause frequent nuisance alarms should be chosen.

Auto Flow—A dialysate flow option in which the dialysate flow is proportional and linked to the blood flow rate. Auto Flow may be approximately either 1.5 times or 2 times the blood flow rate between 300 (or 500 depending on the setup in Service Mode) and 800 ml/min, in 100 ml/min increments. The dialysate flow rate on the “Home” screen is preceded by the letter ‘a’ when auto flow has been set.

Back Filtration—The movement of dialysate across the dialyzer membrane and into the patient’s blood. It can be caused by a change in pressure or concentration gradient between the dialysate and the blood.

Balancing Chambers—A hydraulic unit inside the 2008K² hemodialysis machine consisting of two chambers that ensure that the amount of fresh dialysate entering the dialysate flow is equal to the amount of used dialysate being drained.

Base Na⁺—The prescribed base sodium level for the Final Dialysate, viewable in the SVS subscreen. The default Base Na⁺ value is carried over from the value entered in the Na⁺ button in the Dialysate screen. Changing the value in either button will change the value of the other.

Bic—Abbreviation for “bicarbonate.”

Biofilm—Biological residue from treatment that collects on machine drain lines.

Blood Sensed—The venous line runs through an optical detector below the venous line clamp. When the line is opaque, the machine uses this “Blood Sensed” information for a number of alarm or informational messages or warnings.

BTM (Blood Temperature Monitor)—This is an optional module that can control or monitor the temperature and energy supply to the patient. It may be used to determine the recirculation of blood within the patient’s access.

Button—An area on the display screen that can be selected and will cause an action by the software.

BVM (Blood Volume Monitor)—This is an optional module that can measure the relative fraction of blood cells within the circulating fluid. It can be used to estimate how the machine’s ultrafiltration rate relates the fluid refilling rate from the extra-cellular compartments. If ultrafiltration rate is excessive compared to the refilling rate, a hypotensive event is more likely.

Bypass Mode—Bypass mode occurs when the dialysate goes outside alarm limits for temperature or conductivity. In bypass mode, valves inside the 2008K² hemodialysis machine redirect the flow of dialysate to bypass the dialyzer internally until temperature and conductivity are back within acceptable limits. The 2008K² hemodialysis machine can be manually put into bypass mode by lifting the shunt door.

Compliance Chamber—A blood-holding receptacle similar to a drip chamber. Compliance chambers are part of the arterial bloodline used in single-needle dialysis.

Conc—Abbreviation for “concentrate.”

Dialysate—Aqueous fluid containing electrolytes and usually buffer and glucose, which is intended to exchange solutes with blood during hemodialysis. This is the Final Dialysate, See *Final Dialysate* for more information.

DIASAFE Plus filter—A filter that is placed in the dialysate fluid path after the addition of the acid and bicarbonate concentrates, shortly before the dialysate is delivered to the dialyzer. It substantially reduces the level of bacteria and endotoxin (pyrogenic material) in the dialysate.

eKt/V—Equilibrated Kt/V or double pool Kt/V. This accounts for rebound of urea after the treatment is stopped. The shorter the treatment time, the greater the percentage difference between spKt/V and eKt/V. We use the Tattersall formula to calculate eKt/V.

Fill Program—Occurs when water level in the air separation chamber gets too low. The air separation chamber is part of the hydraulic system inside the 2008K² hemodialysis machine. This program is used to remove excessive air from the hydraulic system. The machine will normally go into a Fill program when the dialyzer is first connected to the dialyzer lines, and the air within the dialyzer is being purged. Repeated Fill programs during operation, however, could indicate a leak in the dialysate delivery system, and should be brought to the attention of a qualified technician.

Final Dialysate—The prescribed dialysate that is delivered to the dialyzer (patient) by the hemodialysis machine after the proportioning (mixing) of the acid concentrate, bicarbonate concentrate, and water. The final dialysate may also be referred to as the post-reaction dialysate (i.e. after proportioning (mixing) of the acid concentrate, bicarbonate concentrate and water by the dialysis machine).

Flow Indicator—A clear, cylindrical section of the dialyzer supply line that allows observation of the dialysate flow. When the dialysate flow is on, a small float inside the cylinder bobs up and down in rhythm to the dialysate pump. When the flow is off, the float sinks to the bottom of the cylinder.

Hard Limits—Unchangeable limits that are hard coded in the software and define the maximum and minimum, alarm-window values for the arterial, venous, and transmembrane pressures, and the dialysate temperature and conductivity. Hard limits are not apparent unless the user attempts to set a value outside the hard limit range.

Hemolysis—Rupture of red blood cells. This may be caused by hyponatremia (low blood sodium), dialysate that is too hot or too dilute (hypotonic), chloramines, copper, or nitrates in dialysate water, bleach in the dialysate, low dialysate conductivity, too-high arterial pressure or kinked blood tubing.

Idle Mode—When dialysis is first entered after a long power down, if a water alarm (temperature or conductivity) exists, the dialysate flow will be 800 ml/min until the machine is up to temperature and conductivity. The dialysate flow then drops to 300 ml/min while the machine is “idle”. The machine will also enter Idle Mode after a treatment is finished (RTD = 0, blood not sensed, and Blood Pump stopped, and the dialysate flow rate > 300 ml/min). This mode is terminated when treatment is started (RTD > 0 or blood sensed by the optical detector) or the dialysate flow rate is changed manually.

Isolated UF—A treatment option in which the ultrafiltration pump draws excess fluid off the patient while the dialysate flow is turned off. See also Sequential Dialysis.

Kecn—Effective Clearance as determined with conductivity measurements. The calculated clearance based on the change in conductivity of the pre-dialyzer versus post dialyzer dialysate. Kecn appears in the “OLC Data” subscreen of the “Kt/V AF” screen.

Keys—Are located on the control panel, outside the display screen. Keys are used to enter numbers, confirm selections on the display screen, change between some screens, and activate certain functions.

KoA—Overall mass transfer coefficient multiplied by surface area of a dialyzer.

Kt/V—A measure of therapy delivered to the patient. (K = clearance rate, t = time, V = urea distribution volume). The Kt/V value shown are Single Pool Values (spKt/V). The OLC system is used to determine the effective dialyzer clearance used for this determination.

KUF—An ultrafiltration coefficient that describes how permeable a dialyzer is to water. It is a direct function of surface area and is defined as the number of millimeters of fluid per hour that are transferred across the membrane per mmHg TMP.

Long Power Down—The act of turning off the machine for longer than two minutes. Certain information stored in memory is lost after two minutes, and some treatment parameters are reset to their default settings. Power failures are not the same as long power downs, and treatment data are saved when power to the machine is interrupted in such instances. See also *Short Power Down* and *Power Failure Recovery*.

Navigation Keypad—The four round arrow keys centered around the **CONFIRM** key. Pressing a navigation key will move between selectable buttons on the display screen or change a toggle-button’s setting.

Low Volume—Option set on the “Test & Options” screen that limits blood pump bloodline segments to less than 6.4mm and reduces arterial and venous pressure limits, ultrafiltration rates, and blood pressure monitor ranges. This option is to be used for patients weighing between 20 kg (44 lbs.) and 40 kg (88 lbs.).

Numeric KoA—See *KoA*.

OLC (Online Clearance)—This is an optional system that can determine the effective conductive clearance of a dialyzer up to six times during dialysis.

Override—All protective systems are in operation during treatment. During a blood leak alarm, the user has the option to temporarily suspend (override) a protective system by pressing and holding the **RESET** key for three seconds. During a blood leak override, the machine’s blood leak monitor is inactive for three minutes. The Status Box will indicate a blood leak override is in effect.

Positive Pressure—Condition that exists when air or fluid pressure inside the dialysate lines is greater than outside of the lines. If an opening occurs, air or fluid will flow out of the system.

Post-Reaction Bicarbonate—The prescribed Final Dialysate bicarbonate that will be delivered to the dialyzer in the Final Dialysate after the proportioning (mixing) of the acid concentrate, bicarbonate concentrate, and water. The post-reaction bicarbonate value is entered on the “Dialysate” screen in the **Bicarbonate** button.

Power Failure Recovery—when power to the machine is lost, many dialysis parameters are stored and recovered when the power is restored to the machine.

Pressure Holding Test (PHT)—There are different Pressure Holding Tests. A PHT verifies the integrity of the hydraulic system, which is necessary for accurate fluid balance and UF control. An extensive Pressure Holding Test is available in Self Test. An Online Pressure Holding Test is done every 12 minutes during treatment. It lasts about seven seconds, depending on the dialysate flow rate (two cycles of the balancing chamber). The online PHT must be selected in Service Mode.

Reverse Osmosis (RO)—A method for purifying water by forcing it through a semipermeable membrane that prevents the passing of mineral ions.

RTD—Remaining Time on Dialysis. The amount of time remaining until the end of the treatment. RTD is viewable in the “Home” screen.

Screen Access Button—Any of the eight blue buttons located in the row along the bottom of the display screen. Pressing the screen-key below one of these buttons will bring up the corresponding treatment screen on the display screen.

Screen Keys—Any of the eight keys located directly below the display screen. Pressing a screen-key will display the corresponding screen of the screen-button above the key.

Sequential Dialysis—A two-stage form of dialysis treatment in which the first stage consists exclusively of ultrafiltration. In the first stage, there is no dialysate flow while the ultrafiltration pump draws excess fluid off the patient. After the determined amount of fluid has been drawn, the second stage, usually a standard dialysis treatment, occurs. See also *Isolated UF*.

Service Mode—A functional state of the 2008K² hemodialysis machine that allows technicians to calibrate the machine or program various software features and options that are only accessible in Service Mode.

Short Power Down—Refers to the act of turning off the power with the Front Panel **Power** key to the machine for less than two minutes. Certain information stored in memory is only stored for up to two minutes. After that, it is erased. See also *Long Power Down* and *Power Failure Recovery*.

Single Needle Dialysis—This is a system with the use of two blood pumps to allow blood access to the patient with a single needle. The pumps alternately turn on and off to pull fluid from the patient and then return the dialyzed blood with minimal recirculation.

SLED—Abbreviation for Sustained Low Efficiency Dialysis, a type of hemodialysis treatment that consists of lower dialysate and blood flow rates for up to 12 hours.

Sodium Variation System (SVS)—A program that varies the concentration of sodium in the dialysate during treatment. Increased sodium at the onset of treatment is sometimes prescribed to prevent cramping in the patient. Increasing sodium results in increased levels of other electrolytic constituents and a higher level of conductivity.

Standard—The type of dialysis selected with the **Dialysis** button from the “Select Program,” screen; a standard patient weighs more than 40 kg.

SVS Profile—A programmable feature for varying the level of sodium in the dialysate throughout the course of treatment.

SVS Time—Time length in hours and minutes prescribed for SVS program.

Theoretical Conductivity (TCD)—The expected conductivity of the dialysate based upon the concentrate type, and sodium and bicarbonate values entered in the Dialysate screen. TCD is measured in milliSiemens per centimeter (mS/cm) and is corrected to 25 °C.

Transducer—An electronic device inside the 2008K² hemodialysis machine that reads the pressure inside the arterial and venous drip chambers. The drip chamber and transducer are connected via a thin tube that is part of the extracorporeal blood circuit.

Transducer Protector (TP)—a small, disposable, plastic cap containing a hydrophobic, paper filter that fits over each pressure port. It is inserted between the pressure monitor line and the pressure port connection and is used to prevent the transducer from becoming wet or contaminated with blood. There are two transducer protectors for each connection, a disposable external TP that is to be replaced with each treatment. A second internal TP is also installed.

Ultrafiltration (UF)—Ultrafiltration is the process of drawing off excess fluid from the patient during treatment. The 2008K² hemodialysis machine hydraulic system is a closed system that uses a separate UF pump for greater accuracy.

Index

#	B
# of Tests button..... 107	Back Filtration 239
1	Balancing Chambers..... 239
1.5x Dialysate flow <i>See</i> Auto Flow	Base Na button.....62, 81
2	Base Na ⁺ 239
2x Dialysate flow <i>See</i> Auto Flow	Bic..... <i>See</i> Bicarbonate
9	Bicarbonate
9-Volt Battery	Connector 38
Alarm..... 119	Biofilm..... 239
Replacing..... 187	Blood Alarms..... 140
A	Blood Leak Detector light29, 142
Access Flow 27, 105, 109, 232	Blood lines
Acid	priming 49
Connector 38	Blood Pressure .12, 27, 36, 92, 116, 220, 233
Acid Clean program..... 131	Blood pressure test..... 117
Acid/Bicarbonate Alert	unscheduled..... 117
button..... 62	Blood pump
setting 68	hand crank 119
Acid/Bicarbonate Type	preparing for treatment.....47, 191, 198
setting 66	Blood pump module
Actual Conductivity 60, 69, 83	description 32
Actual Time data box..... 111	Blood Recirculation 118, 200
Air lock 44	Blood Sensed 154, 173, 239
Air Lock..... 239	Blood Temperature Monitor Screen113, <i>See also</i>
Alarm Position button..... 62	BTM
Alarm Status..... 140	Blood tubing <i>See also</i> Blood lines,
Alarm Width button 62	extracorporeal blood circuit
Alarm window 239	requirements 36
Alarms..... 138, 200	Blood Volume Monitor Screen 113, <i>See also</i>
Arterial pressure	BVM
monitoring 99	Blood Volume Processed
Arterial Width button..... 90	data box 107, 111
Asymmetric Limits 239	data box in SLED 204
Auto Disinfect..... 218	Bloodlines
Auto Flow 50, 51, 214, 239	priming 193
Minimum button 216	Bolus button..... 85
Selection button 216	BTM 113, 232, 239
	Button 239
	BVM..... 113, 232, 240
	Bypass light 30
	Bypass mode.....39, 240

- C**
- Central Venous Catheter 18
 - Chemical/Dwell program..... 135
 - Chemical/Rinse program 133
 - Citrasate® 63, 212
 - Citrate..... 212
 - Cleaning and Disinfection..... 125
 - Clock..... 94, 220
 - Compliance Chamber..... 240
 - Conc *See* Concentrate
 - Conc button..... 62
 - Concentrate Connectors 38
 - Concentrate Containers
 - Connector caps 38
 - disinfecting 128
 - in preparation for treatment 44
 - Concentrates 207, *See also* Acid/Bicarbonate Types
 - Concentrates, adding new 209
 - Conductivity..... 69
 - limits 69
 - Conductivity button 73, 98
 - CONFIRM key
 - description 27
 - Control Panel 23
 - Crank..... *See* Blood pump, hand crank
- D**
- Default Dial Flow button 216
 - Delivered Kt data box 112
 - Delivered Kt/V
 - data box, equilibrated 112
 - data box, single-pool..... 112
 - Dialogue Box 26, 138
 - Dialysate 240
 - Dialysate Alarms..... 142
 - Dialysate Flow button 73, 98, 214
 - Dialysate Flow key 30
 - Dialysate path..... 37
 - Dialysate Screen
 - settings..... 60
 - Dialyzer
 - Connectors 39
 - Holder 41
 - requirements 39
 - Dialyzer Time data box..... 204
 - Diasafe Plus filter..... 240
 - Diasafe Plus Filter
 - Replacing..... 187
 - Testing 55, 134
- E**
- Disinfectant
 - testing for..... 137
- F**
- eKt/V 240
 - Electrolyte Constituents..... 83
 - Electromagnetic
 - Emissions 235
 - Environment 235
 - Immunity 235
 - Enable OLC button 106
 - Escape key
 - description 27
 - Exp button *See* Exponential Profile (SVS) button
 - Exponential Profile (SVS) button..... 81
 - Extracorporeal Blood Circuit
 - preparing..... 45
- G**
- GranuFlo..... 63, 211
- H**
- Hard Limits..... 240
 - Hardware key..... 224
 - Heat Disinfect program 132, 218
 - Hemolysis 240
 - Heparin
 - Bolus 85
 - Heparin Delivery system
 - preparing..... 86
 - Heparin Dwell..... 221
 - Heparin on/off key..... 29, 86
 - Heparin Prime button..... 85
 - Heparin pump 34
 - Heparin Rate button..... 204
 - Heparin screen
 - settings..... 84
 - High Flux button..... 90
 - Home screen
 - monitoring the treatment 97

I	
I.V. Pole	41
Idle Mode	241
Inflation Pressure button	94
Infuse Bolus button	85
Infusion Time button	85
Interval button	94
Isolated UF	See Sequential Dialysis
IV Pole	21, 41

J

Jugs See Concentrate Containers

K

Kecn	241
in OLC table	112
Keys	241
KoA	241
Kt/V	241
Kt/V Calculator button	106
Kt/V graph	107
Kt/V screen	105
KUF	241

L

Last Reset data box	204
Level Adjust key	32, 33
Level Detector Adjust key	36
Level Detector light	29, 142
Level Detector module	35
Lin button... See Linear Profile (SVS) button	
Linear Profile (SVS) button	81
Load Syringe button	85
Long Power Down	241
Low Volume	
button	90
button (grayed-out)	90
description	232
Lower Dia button	93
Lower Pulse button	93
Lower Sys button	93

M

Machine Specifications	226
Manual Circulation	120
Manual OLC Test button	106
MAP	See Mean Arterial Pressure
Maximum UF Rate	76

Mean Arterial Pressure	117
Minor light	29, 142
Moving the machine	41
Mute key	141
description	25

N

NaturaLyte	63
Navigation keypad	27
Navigation Keypad	241
New Treatment key	58
New TX key	See New Treatment key
description	25
None (SVS) button	81
Normal Status	139

O

OLC	See Online Clearance
OLC Data button	106
OLC Data screen	111
Online Clearance	105, 241
Online PHT See Online Pressure Holding Test	
Online Pressure Holding Test	55, 117, 242
Optical Detector	36
Override	241
Override key	141
description	28

P

P art	See Pressure Port, arterial
P ven.	See Pressure port, venous
Patient ID button	90
PHT	See Pressure Holding Test
Plasma Na data box	111
Positive Pressure	241
Post-Reaction Bicarbonate	242
Power Failure	119, 200
during chemical disinfection	137
resumption procedure	121
Power key	
description	24
Pressure and Alarm tests	52, 195, 197, 200
Pressure Holding Test	242
Pressure port	
arterial	33
venous	36
Prime Amount	50, 194
Prime key	
description	29

- Pump segment..... 36
- Q**
- Quick Connectors..... 39
- R**
- Rate button..... 85
- Reset key
description 25
- RESET key 141
- Reset Treatment 58
- Reverse Osmosis..... 242
- Rinse program..... 130
- RO..... See Reverse Osmosis
- RTD 242
- in Kt/V graph..... 107
- RTD button 73, 98
- S**
- Screen Access Button 242
- Screen key 27
- Screen Keys 242
- Select Program screen..... 44, 125
- SEQ..... See Sequential Dialysis
- Sequential Dialysis..... 78, 242
- Service mode..... 189, 242
- Short Power Down..... 242
- Shunt Interlock..... 39
- Single Needle..... 46, 189, 229
- Single Needle button..... 90
- Single Needle Dialysis..... 242
- SLED Mode 202
- description 232
- Sodium Variation System 80, 242
- Standard Prime..... 49, 193
- Start Na button 81
- Start/Stop key
for blood pump 33
- Stat/Deflate key..... 117
- description 29
- Status box..... 138
- description 26
- Step Profile (SVS) button 81
- storage and maintenance 225
- Storage Preparation..... 225
- Sustained Low Efficiency Dialysis See SLED Mode
- SVS..... See Sodium Variation System
- SVS on/off key..... 30, 74, 82
- SVS Profile..... 243
- setting 82
- SVS Profile button..... 62, 73
- SVS Service Mode option 221
- SVS Time 243
- SVS Time button 81
- Syringe button..... 85
- T**
- Target Kt/V..... 107, 222
- data box 112
- less than 85 percent 108
- Target Kt/V button..... 106
- TCD See Theoretical Conductivity
- Temperature button..... 73, 98
- Test & Options screen
settings..... 89
- Testing ... See Pressure and Alarm Tests, See Pressure and Alarm Tests
- Theoretical Conductivity 69, 83, 243
- TMP..... See Transmembrane Pressure
- Total Infused button..... 85
- Transducer 243
- Transducer Protector..... 47, 191, 243
- Transmembrane pressure
monitoring 100
- Treatment Clock button 74
- Treatment Parameters
entering..... 59
- Treatment Summary 26, 102
- Trends screen..... 102
- Troubleshooting..... 142
- TX Clock button 98
- U**
- UF See Ultrafiltration
- UF Goal button 72
- UF on/off key..... 30, 74
- UF Profile 75, 213
- UF Profile button 73
- UF Rate button..... 72, 98
- UF Removed button..... 98
- UF Time button 72, 97
- Ultrafiltration 37, 75, 243
- Upper Dia button 93
- Upper Pulse button 93
- Upper Sys button 93

Index

V

Venous Line Clamp 36
Venous pressure
 monitoring 99
Venous Width button 90
Volume (OLC)
 Button 106

Data box 111

W

Warning Status 139
Water Supply
 maintenance..... 129
Wheel Lock..... 41