

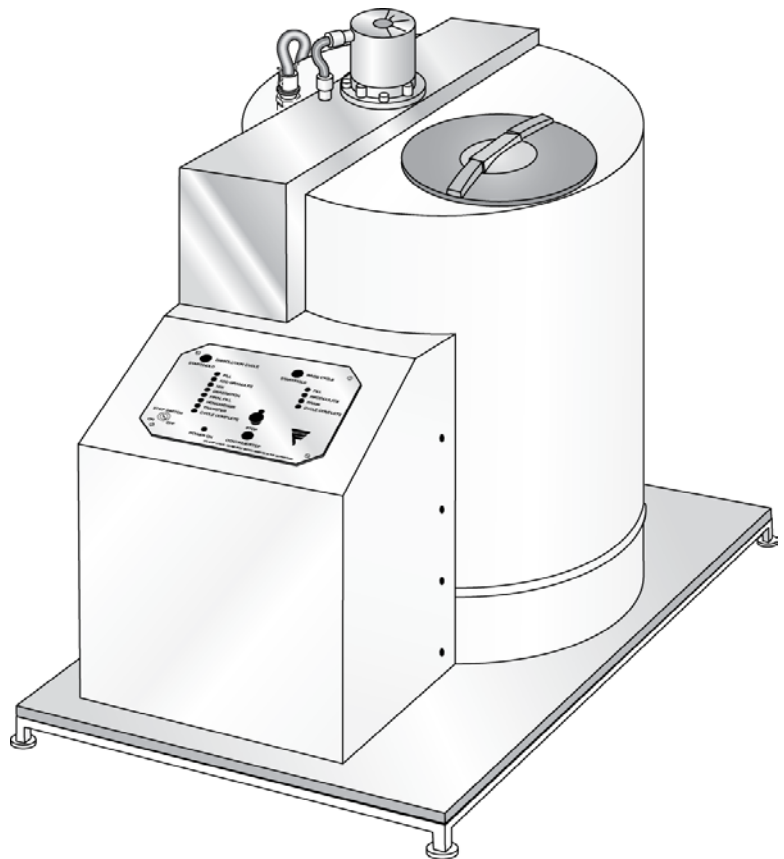

**FRESENIUS
MEDICAL CARE**

**GranuFlo®
CONCENTRATE
DISSOLUTION UNIT I
Version 1**



OPERATOR'S MANUAL

P/N G89-290-09 Rev. S

(PAGE INTENTIONALLY LEFT BLANK)

Fresenius Medical Care GranuFlo I Dissolution Unit: 132 Gallons (500 Liters) Operator's Manual

© 1998-2013, 2016, 2017-2020 Fresenius USA, Inc. – All Rights Reserved.

This document contains proprietary and confidential information from Fresenius USA, Inc. The contents of this manual may not be disclosed to third parties, copied, or duplicated in any form, in whole or in part, without the prior written permission of Fresenius USA, Inc.

Fresenius Medical Care, the triangle logo and GranuFlo are trademarks of Fresenius Medical Care Holdings, Inc. or its affiliated companies. All other trademarks are the property of their respective owners.

Caution: US Federal Law restricts this device to sale by or on the order of a physician.

As part of the Condition for Coverage, it is the Medical Director's responsibility that the operator(s) of the Fresenius Medical Care GranuFlo I Dissolution Unit must be trained in its operation and thoroughly familiar with the contents of this manual. Operators must be proficient and able to distinguish between normal and abnormal operation.

Assembly, adjustment, or repair is to be performed only by persons authorized by the facility medical director or by Fresenius USA, Inc. Installation is only to be performed by Fresenius USA, Inc. to prevent voiding of product warranty. Fresenius Medical Care Concentrate GranuFlo I Dissolution Unit spare parts manuals, PN450363, Field Service Bulletins, and other documentation are located on the internet at <http://www.fmcna.com>.

Only Original Equipment Manufacturer (*OEM*) Fresenius Medical Care parts should be used in the repair or upgrade of the Fresenius Medical Care GranuFlo I Dissolution Unit. Although, parts may look similar to parts in various vendor catalogs or brick and mortar stores the GranuFlo I Dissolution Unit uses parts that have been specified and tested in accordance to *ANSI/AAMI/ISO* guidelines. The use of non-*OEM* parts will void your warranty and may cause patient harm.

For further information regarding the operation, repair, parts, or maintenance of the Fresenius Medical Care GranuFlo I Dissolution Unit, please contact:

Fresenius USA, Inc.
ATTN: Service Department
4040 Nelson Avenue
Concord, CA 94520.

(800) 227-2572

(PAGE INTENTIONALLY LEFT BLANK)

TABLE OF CONTENTS



SECTION	TOPIC	PAGE
	IMPORTANT SAFETY SYMBOLS AND INSTRUCTIONS	1
SECTION 1:	OVERVIEW	2
SECTION 2:	SPECIFICATIONS AND PRE-INSTALLATION REQUIREMENTS	3
SECTION 3:	PRODUCT IMPROVEMENT POLICY	4
SECTION 4:	WARNINGS AND CAUTIONS	5
DIAGRAM 1:	FRONT PANEL BUTTONS AND INDICATOR LIGHTS/CYCLE PROGRAM OVERVIEW	8
DIAGRAM 2:	EXTERNAL AND INTERNAL GRANUFLO I DISSOLUTION UNIT PARTS.....	9
SECTION 5:	GRANUFLO DISSOLUTION UNIT PREPARATION.....	10
SECTION 6:	RINSE CYCLE	11
SECTION 7:	DISSOLUTION CYCLE	14
	7.1 TRANSFER HOSE FLUSH AND SPECIFIC GRAVITY TEST:	17
	7.2 TRANSFER TO STORAGE TANK:	20
	7.3 TRANSFER TO INDIVIDUAL CONTAINER:	21
SECTION 8:	MAINTENANCE	22
	8.1 VISUAL INSPECTION	22
	8.2 CLEANING.....	22
	8.3 SODIUM HYPOCHLORITE (REGULAR BLEACH) DISINFECTION	22
	8.4. FILTER MAINTENANCE	25
	8.5. SENSOR REPLACEMENT	25
SECTION 9:	MANUAL CONTROL OPERATIONS	26
	9.1 HOLD STATE	26
	9.2 STOP STATE	26
	9.3 STEP MODE	26
	9.4 MAIN POWER DISCONNECT	27
DIAGRAM 3:	HYDRAULIC/ELECTRICAL	28
TABLE 1:	ROUTINE MAINTENANCE SCHEDULE	29
SECTION 10:	TECHNICAL SERVICE.....	33
SECTION 11:	LIMITED WARRANTY.....	35
SECTION 12:	CUSTOMER SUPPORT	37
SECTION 13:	DEFINITION OF TERMS	39
SECTION 14:	CONCENTRATE SOLUTION DISPOSAL OR DISPOSITION.....	41
	14.1 RESIDUAL SOLUTION DISPOSAL OR DISPOSITION	41
	14.2 TANK SOLUTION DISPOSAL.....	41
APPENDIX A:	DRY ACID MIXING INSTRUCTIONS	43
APPENDIX B:	FIRST BATCH VERIFICATION INSTRUCTIONS	51
BATCH ANALYSIS FORM	53

(PAGE INTENTIONALLY LEFT BLANK)

READ ALL INSTRUCTIONS BEFORE USE!

For your safety, the information in this manual must be followed to minimize the risk of electrical shock, prevent property damage, personal injury, or loss of life. There are many important safety messages in this manual and on your GranuFlo I Dissolution Unit. The following table lists symbols and the criteria of their descriptions, which is used throughout this manual. Your safety and the safety of others are very important. Always read and abide by all safety messages.

Proper training and demonstrated user competency must be completed and documented before a designated operator can be authorized to use the Fresenius Medical Care GranuFlo I Dissolution Unit to make Fresenius Medical Care Dry Acid Concentrate.

SYMBOL	DESCRIPTION
	WARNING! A WARNING IS A STATEMENT THAT IDENTIFIES CONDITIONS OR ACTIONS THAT COULD RESULT IN PERSONAL INJURY OR LOSS OF LIFE. WARNINGS FOUND IN THIS MANUAL OUTSIDE OF THIS SECTION ARE DESIGNATED WITH THE WARNING SYMBOL.
	NOTE: NOTES ARE ADVISORY COMMENTS OR RECOMMENDATIONS REGARDING PRACTICES OR PROCEDURES.
BUTTON	A BUTTON IS A PRESSURE-SENSITIVE, RAISED PAD FOUND ON THE CONTROL PANEL THAT IS USED TO INITIATE AN ACTION OR PROCESS.
<i>ITALICIZED WORDS</i>	ITALICIZED WORDS IN TEXT INDICATES THE WORD IS DEFINED IN SECTION 13: DEFINITION OF TERMS, PAGE 39.

SECTION 1: OVERVIEW

This product is manufactured by:

Fresenius USA, Inc.
4040 Nelson Avenue,
Concord CA 94520.

Fresenius USA, Inc. is a wholly owned subsidiary of Fresenius Medical Care Holdings, Inc.





The Fresenius Medical Care GranuFlo I Dissolution Unit is automated and designed to mix a 500 liter (132 gallon) batch of dialysate concentrate with a minimum of operator supervision, and is to be only used for the mixing of Granuflo® product.

There are two (2) pre-programmed cycles built into the Fresenius Medical Care GranuFlo I Dissolution Unit; the **RINSE CYCLE** and the **DISSOLUTION CYCLE**. The RINSE CYCLE has four operations- FILL, RECIRCULATE, DRAIN, and CYCLE COMPLETE. The first three: FILL, RECIRCULATE, and DRAIN are done twice before it reaches CYCLE COMPLETE Operation. The DISSOLUTION CYCLE has eight operations-FILL, ADD GRANUALES, MIX, DEAERATION, FINAL FILL, HOMOGENIZE, TRANSFER, and CYCLE COMPLETE

The control panel will display the GranuFlo I Dissolution Unit status at any given time, making it easy for the operator to follow the progress of the operations in each cycle. The right side of the panel displays the RINSE CYCLE, and the left side of the panel displays the DISSOLUTION CYCLE.

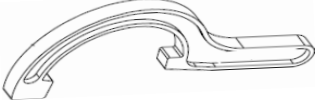
In addition, a manual override has been incorporated into the unit (See Section 9, page 26).

The following components are typical equipment for use with this device. Note: Hydrometer listed below may be supplied with the machine but its use is not mandatory. Use of any hydrometer that is calibrated at 60°F following ASTM Standard E126 is permitted.

Description	Part Number
1. Hydrometer, Range 1.000 – 1.220	G84-001-60
2. Hydrometer, Range 1.180 – 1.210	390591
3. 1 Micron Filter Cartridge	G84-202-12
4. Filter Housing Wrench 	G84-001-43
5. Tank Nozzle Assembly 	G97-283-08
6. ¾" Dust CAP 	332107-10-01
7. ¾" Hose Shank Coupler 	G84-001-57
8. ¾" Male Adapter 	332107-10

For other Original Equipment Parts see Spare Part Manual, PN450363, on www.fmcna.com.

SECTION 2: SPECIFICATIONS AND PRE-INSTALLATION REQUIREMENTS

Prior to operating the Fresenius Medical Care GranuFlo I Dissolution Unit: 132 Gallons (500 Liters), adequate power and water connections must be made. The GranuFlo I Dissolution Unit should be installed in an appropriate environment (indoors) free from extremes of temperature and humidity, free of the presence of flammable anesthetics, reasonably protected from dust and dirt contamination, liquid splashes, bright sunlight or high intensity lighting.

Failure to install the GranuFlo I Dissolution Unit according to these guidelines may result in improper operation or early failure of the device or its components. Direct sunlight or high intensity lighting may interfere with the proper operation of the optical sensors. Direct sunlight may cause discoloration of the polypropylene tank, lid or electronic housing.

The GranuFlo I Dissolution Unit needs to be set up using the following parameters:

1. A 15 amp *GFI* duplex outlet is required. The GranuFlo I Dissolution Unit requires 120 VAC, 60 Hz, single phase power. The GranuFlo I Dissolution Unit uses approximately 7.3 amperes total. Electrical service should meet all applicable national, state and local code requirements.
2. The electrical power cord, input water hose, and output drain hose shall be properly routed away from high traffic areas and installed in such a way that does not cause any electrical or safety hazards.



NOTE: THE GRANUFLO I DISSOLUTION UNIT'S TANK IS MADE OF NON-FERROUS MATERIAL AND ALL METAL SURFACES ARE GROUNDED.

3. The treated water source must meet *ANSI/AAMI* or *ISO* requirements for water for hemodialysis, currently *ANSI/AAMI RD62*, or *ISO 13959*. Plumbing service must meet all national, state and local plumbing codes. The GranuFlo I Dissolution Unit uses approximately 132 gallons (500 liters) of water per batch of product.



WARNING! DO NOT PERMANENTLY INSTALL TRANSFER HOSE TO A STORAGE TANK/CONTAINER.

4. Supply water treatment system should be capable of a minimum flow rate of ½ gallon per minute. The maximum input water pressure is 60 psi.
5. The water temperature should be 20°-30°C (68°-86°F) for proper dissolution mixing conditions.
6. Height from floor to top of motor is 60 inches.
7. Platform for the GranuFlo I Dissolution Unit is 55 inches long by 36 inches wide.
8. Transfer filter housing is equipped with a ¾" hose barb fitting.
9. There is a ¾" hose barb inlet fitting, and another for the drain outlet.
10. GranuFlo I Dissolution Unit must be level.
11. GranuFlo I Dissolution Unit weight is 395 lbs. empty and 1,775 lbs. filled.



CAUTION! THE FLOOR MUST BE CAPABLE OF WITHSTANDING THE MAXIMUM WEIGHT OF 1,775 POUNDS.

A floor drain emptying into a sewer line must be in the immediate area of the GranuFlo I Dissolution Unit.

SECTION 3: PRODUCT IMPROVEMENT POLICY

The GranuFlo I Dissolution Unit is designed and built to comply with its product specifications. It is the intention of Fresenius Medical Care to pursue product development that may result in modifications or improvements to specifications or equipment produced in the future. Such product improvements shall not force similar changes and improvements to equipment produced prior to the changes. Product development may or may not be applicable or usable with previously produced equipment. Where possible, improvements will be made available at reasonable prices. These improvements shall not be construed as corrections of any deficiency.

SECTION 4: WARNINGS AND CAUTIONS



WARNING! NEVER PUT YOUR HEAD INTO THE GRANUFLO I DISSOLUTION UNIT TANK. THIS MAY RESULT IN OPERATOR FALLING INTO TANK.



WARNING! IN THE EVENT OF A FOREIGN OBJECT FALLING INTO THE TANK DURING ANY ACTIVE OPERATION, THE OPERATION SHOULD BE PAUSED. IF NEEDED, USE STEP MODE TO PLACE UNIT INTO A DRAIN OPERATION TO EMPTY THE TANK. IF CONCENTRATE SOLUTION NEEDS TO BE DISPOSED, MAKE SURE TO COMPLY WITH LOCAL, STATE AND FEDERAL REQUIREMENTS. AFTER DRAIN OPERATION, UNPLUG GRANUFLO I DISSOLUTION UNIT FROM ITS POWER SOURCE. A REACH TOOL IS RECOMMENDED FOR REMOVING FOREIGN OBJECT OUT OF TANK. HOWEVER, SHOULD THE FOREIGN OBJECT BE UNATTAINABLE, CALL TECHNICAL SERVICE FOR FURTHER ASSISTANCE (1-800-227-2572).



WARNING! IF THE GRANUFLO I DISSOLUTION UNIT IS RELOCATED, THEN A SAMPLE MUST BE DRAWN FROM THE FIRST BATCH OF CONCENTRATE MADE AND IT MUST BE ANALYZED FOR CORRECT SOLUTION MIX BEFORE THE CONCENTRATE CAN BE USED. PRIOR TO RELOCATION, REQUEST TWO (2) EMPTY SAMPLE BOTTLES (P/N G83-535-02) THEN SEE APPENDIX B: FIRST BATCH VERIFICATION FOR FURTHER INSTRUCTIONS ON WHEN AND WHERE TO SEND SAMPLE OF THE FIRST BATCH OF CONCENTRATE.



WARNING! THE USE OF EYE PROTECTION, AND GLOVES IS RECOMMENDED WHEN HANDLING DRY ACID PRODUCT. IF CONTACT WITH EYES, RINSE IMMEDIATELY FOR 15 MINUTES. IF CONTACT WITH SKIN, FLUSH WITH PLENTY OF SOAP AND WATER. SEE MATERIAL SAFETY DATA SHEETS (MSDS) FOR THE DRY ACID PRODUCT BEING USED FOR FURTHER PERSONAL PROTECTIVE EQUIPMENT (PPE) OR EMERGENCY REQUIREMENTS/INSTRUCTIONS.



WARNING! SHOULD THE GRANUFLO I DISSOLUTION UNIT FAIL TO COMPLETE ANY OPERATION WITHIN ANY CYCLE DO NOT PROCEED THROUGH CYCLE USING STEP MODE. CALL TECHNICAL SERVICE FOR FURTHER ASSISTANCE (1-800-227-2572).



WARNING! FAILURE TO INSTALL, OPERATE, AND MAINTAIN THIS EQUIPMENT ACCORDING TO THE MANUFACTURER'S INSTRUCTIONS MAY CAUSE PATIENT DEATH OR INJURY.



WARNING! THIS GRANUFLO I DISSOLUTION UNIT MAY BE SUSCEPTIBLE TO ELECTROMAGNETIC INTERFERENCE (EMI). DEVICES EMITTING ELECTROMAGNETIC RADIATION SUCH AS ANALOG PORTABLE PHONES, RADIO EQUIPMENT (WALKIE-TALKIES, ETC.), RADIO TRANSMITTERS, AND LIKE EQUIPMENT, SHOULD NOT BE USED IN THE VICINITY OF THIS EQUIPMENT. THE OPERATOR SHOULD MONITOR THE FUNCTION OF THE MACHINE AND REMOVE UNNECESSARY EQUIPMENT FROM THE TREATMENT AREA SHOULD THESE EVENTS OCCUR.



WARNING! THE ELECTRICAL SOURCE MUST BE SINGLE PHASE, THREE-CONDUCTOR TYPE PROVIDED WITH A GROUND FAULT INTERRUPTER AT 120VAC, 60 Hz. THE PROPER POLARITY AND GROUND INTEGRITY MUST BE INITIALLY CHECKED AND MAINTAINED. FAILURE TO DO SO MAY RESULT IN ELECTRICAL SHOCK OR BURN TO THE OPERATOR.



WARNING! SHOCK HAZARD. DO NOT REMOVE COVERS. REFER SERVICING TO QUALIFIED PERSONNEL. REPLACE FUSES ONLY WITH THE SAME TYPE AND RATING.



WARNING! FAILURE TO FLUSH THE TRANSFER HOSE WITH 3.5 GALLONS PRIOR TO MEASURING SPECIFIC GRAVITY MAY RESULT IN AN INCORRECT SPECIFIC GRAVITY READING, AND/OR SUPPLY OF AN INCORRECT CONCENTRATE FORMULATION TO THE HEMODIALYSIS MACHINE, WHICH MAY RESULT IN PATIENT INJURY OR DEATH. SEE SECTION 7.1, #5, PAGE 17.



WARNING! FOLLOWING DISINFECTION, TWO (2) COMPLETE RINSE CYCLES MUST BE PERFORMED AND THE UNIT TESTED TO ENSURE THE ABSENCE OF RESIDUAL BLEACH (SEE SECTION 8.3 SODIUM HYPOCHLORITE (REGULAR BLEACH) DISINFECTION, PAGE 22).



WARNING! FOLLOW THE MANUFACTURER'S INSTRUCTIONS WHEN MEASURING THE *SPECIFIC GRAVITY* OF A SAMPLE OF THE MIXED FRESenius MEDICAL CARE DRY ACID PRODUCT (SEE FORM 1 FOR GRANUFLO® PRODUCT, PAGE 31) WITH A HYDROMETER CALIBRATED AT 60°F FOLLOWING ASTM STANDARD E126 PRIOR TO TRANSFERRING TO A DIALYSIS MACHINE OR HOLDING TANK.



WARNING! CONNECT WATER INLET ACCORDING TO THE SPECIFICATIONS FOR THE GRANUFLO I DISSOLUTION UNIT. THE WATER USED MUST MEET *ANSI/AAMI* OR *ISO* STANDARDS FOR WATER USED IN HEMODIALYSIS (CURRENTLY *ANSI/AAMI RD62*, OR *ISO 13959*). THE CORRECT IONIC CONCENTRATION AND BACTERIAL QUALITY CAN GENERALLY BE ACHIEVED IN THE DIALYSATE ONLY WITH TREATED WATER. BE SURE THAT ALL SPECIFICATIONS ARE SATISFIED. THE WATER SOURCE MUST BE MONITORED PERIODICALLY TO DETECT FLUCTUATIONS IN WATER COMPOSITION AND QUALITY THAT COULD HAVE AN ADVERSE EFFECT ON THE PATIENT, HEMODIALYSIS MACHINE OR GRANUFLO I DISSOLUTION UNIT. PARTICULAR ATTENTION MUST BE TAKEN FOR CHEMICALS SUCH AS ALUMINUM, CHLORINE, AND CHLORAMINES, AS THESE CHEMICALS CAN CAUSE COMPLICATIONS IN DIALYSIS PATIENTS. THE CHEMICAL QUALITY OF THE TREATED WATER USED FOR DIALYSIS SHOULD BE ANALYZED AT LEAST ONCE A YEAR TO ENSURE IT MEETS THE REQUIREMENTS OF *ANSI/AAMI RD62*, OR *ISO 13959*.



WARNING! THE DIALYSIS PHYSICIAN IS RESPONSIBLE FOR SELECTING THE APPROPRIATE CONCENTRATE MIXING EQUIPMENT FOR DIALYSIS AND THE PRESCRIPTION FOR DIALYSIS.



WARNING! IN ABSENCE OF SIGNIFICANT CLUMPING, ONLY USE THE SMALL ACCESS LID WHEN POURING ACID CONCENTRATE INTO THE MIXER. USE OF THE LARGE ACCESS LID WHEN POURING ACID CONCENTRATE MAY RESULT IN INHALATION INJURY.



WARNING! ALWAYS CHECK THE SPECIFIC GRAVITY OF EACH NEW BATCH OF ACID CONCENTRATE BEFORE USING IN TREATMENT. SUPPLYING AN IMPROPERLY MIXED ACID CONCENTRATE TO THE HEMODIALYSIS MACHINE MAY RESULT IN PATIENT INJURY OR DEATH.



WARNING: IN ORDER TO ACCURATELY DETERMINE IF THE ACID CONCENTRATE HAS BEEN PREPARED CORRECTLY, THE TEMPERATURE OF THE SOLUTION MUST BE MEASURED AND THE SPECIFIC GRAVITIES TABLE IN FORM 1 (GRANUFLO) OR FORM 2 (CITRASATE DRY) MUST BE CONSULTED. SUPPLYING AN INCORRECTLY PREPARED ACID CONCENTRATE TO THE HEMODIALYSIS MACHINE MAY RESULT IN PATIENT INJURY OR DEATH.



WARNING! THE FLUSH SOLUTION IS A MIXTURE OF CONCENTRATE FROM THE PREVIOUS BATCH AND THE NEW BATCH. THE COMPOSITION OF THE FLUSH SOLUTION MUST BE CONSIDERED WHEN DETERMINING CLINIC POLICIES FOR DISPOSITION OF THE FLUSH SOLUTION. SUPPLY OF AN INCORRECT CONCENTRATE FORMULATION TO THE HEMODIALYSIS MACHINE MAY RESULT IN PATIENT INJURY OR DEATH.



CAUTION! THE GRANUFLO I DISSOLUTION UNIT IS COMPUTER CONTROLLED. EXTREME CARE SHOULD BE EXERCISED IN ITS OPERATION. WHEN POWER IS CONNECTED TO THE GRANUFLO I DISSOLUTION UNIT, A FAILURE OF THE COMPUTER COULD START ANY OF THE OPERATIONS AT ANY TIME.



CAUTION! ASSEMBLY, INSTALLATION, ADJUSTMENT, OR REPAIR IS TO BE PERFORMED ONLY BY PERSONS AUTHORIZED BY THE FACILITY MEDICAL DIRECTOR OR BY FRESenius MEDICAL CARE.



CAUTION! DISINFECT GRANUFLO I DISSOLUTION UNIT TANK IF WATER IN TANK UNIT EXCEEDS 200 CFU/ML AS OUTLINED BY *ANSI/AAMI RD62*, OR *ISO 13959* (REFER TO SECTION 8.3: SODIUM HYPOCHLORITE (REGULAR BLEACH) DISINFECTION, PAGE 22).



CAUTION! THE GRANUFLO I DISSOLUTION UNIT IS ONLY INTENDED FOR MIXING FRESenius MEDICAL CARE DISTRIBUTED DRY ACID CONCENTRATE. DO NOT MIX BICARBONATE IN THE GRANUFLO I DISSOLUTION UNIT.



CAUTION! AN *ANSI/AAMI* OR *ISO* STANDARD PURIFIED WATER ANALYSIS FOR BACTERIA AND ENDOTOXIN IS RECOMMENDED MONTHLY.



CAUTION! A BACK PRESSURE REGULATOR MAY BE REQUIRED ON THE TREATED WATER FEED LINE IF THE GRANUFLO I DISSOLUTION UNIT IS TO BE USED AT THE SAME TIME AS OTHER DIALYSIS EQUIPMENT. THE MAXIMUM INPUT WATER PRESSURE IS 60 PSI AT A MINIMUM FLOW RATE OF ½ GALLON PER MINUTE FOR THE GRANUFLO I DISSOLUTION UNIT.



CAUTION! KEEP THE GRANUFLO I DISSOLUTION UNIT MIXING AREA FREE OF CLUTTER. THE FLOOR NEAR THE UNIT SHOULD BE KEPT FREE OF WATER TO AVOID SLIP-AND-FALL INJURIES



CAUTION! IF A GRANUFLO I DISSOLUTION UNIT IS FOUND TO BE STANDING FOR 4 OR MORE HOURS WITH TREATED WATER OR WETTED WITH TREATED WATER, THEN A DISINFECTION CYCLE (SEE SECTION 8.3 SODIUM HYPOCHLORITE (BLEACH) DISINFECTION, PAGE 22) MUST BE COMPLETED BEFORE THE DISSOLUTION CYCLE IS STARTED. IMMEDIATELY AFTER COMPLETED RINSE CYCLE, MAKE A BATCH OF DRY ACID PRODUCT. DO NOT LEAVE THE GRANUFLO I DISSOLUTION UNIT WITH ONLY TREATED WATER OR WETTED WITH ONLY TREATED WATER FOR 4 OR MORE HOURS SINCE THE GRANUFLO I DISSOLUTION UNIT IS SUSCEPTIBLE TO BACTERIAL GROWTH.



NOTE: SOME FACILITIES MAY BE REQUIRED TO PURCHASE AND INSTALL A STORAGE TANK FOR CENTRALIZED ACID FEED LOOPS. IF SO, THE STORAGE TANK AND ASSOCIATED PLUMBING INTERCONNECTIONS MUST BE COMPLETED PRIOR TO THE INSTALLATION OF THE GRANUFLO I DISSOLUTION UNIT.



NOTE: IF THE FINAL FILL SENSOR NEEDS ADJUSTMENT OR REPLACEMENT, THEN A QUALIFIED TECHNICAL PERSONNEL SHALL COMPLETE THIS AND THE FOLLOWING TASKS. SAMPLE MUST BE DRAWN FROM THE FIRST BATCH OF CONCENTRATE MIXED. THIS SAMPLE MUST BE ANALYZED FOR CORRECT SOLUTION MIX BEFORE THE CONCENTRATE CAN BE USED. BEFORE REPLACING THE FINAL FILL SENSOR OR RELOCATING THE GRANUFLO I DISSOLUTION UNIT CONTACT FRESenius MEDICAL CARE TECHNICAL SERVICE AT 1 (800) 227-2572 AND REQUEST TWO (2) EMPTY SAMPLE BOTTLES (P/N G83-535-02). SEE APPENDIX B, PAGE 51, FOR FURTHER INSTRUCTIONS.

NOTE: THE RECIRCULATION/TRANSFER PUMP IS NOT SELF-PRIMING AND IS INSTALLED WITH A POSITIVE FLOODED SUCTION. THE LIQUID BEING PUMPED SERVES AS THE LUBRICATION FOR THE IMPELLER ASSEMBLY SPINNING ON A POLYPROPYLENE STATIONARY SHAFT. IF THE PUMP IS RUN DRY FOR LONGER THAN 30 SECONDS THIS MAY CAUSE IMPELLER DAMAGE.



RECIRCULATION/TRANSFER MANUFACTURE PUMP RATINGS AND SPECIFICATIONS							
ELECTRICAL			GPM AT LISTED HEAD (60HZ)				
HP	VOLTS	AMPS	1 FT	10 FT	20 FT	30 FT	40 FT
1/3	115/230	3.6/1.8	27	23	18.2	11.7	1.5



NOTE: CONCENTRATE SOLUTION MUST BE DISPOSED OF IN ACCORDANCE WITH LOCAL, STATE, AND FEDERAL REQUIREMENTS. IF YOU HAVE QUESTIONS REGARDING THE DISPOSAL OF CONCENTRATE SOLUTION, THEN SEE SECTION 13: CONCENTRATE SOLUTION DISPOSAL, PAGE 41.

DIAGRAM 1: FRONT PANEL BUTTONS AND INDICATOR LIGHTS/CYCLE PROGRAM OVERVIEW

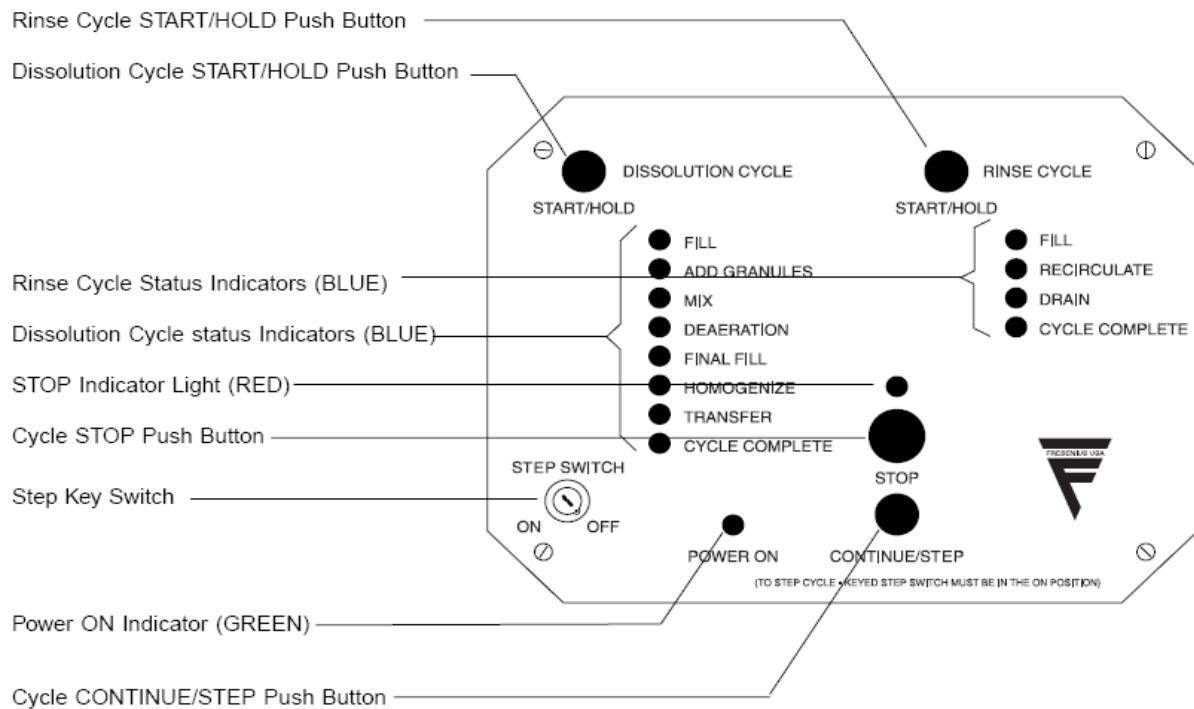

Dissolution Cycle consists of the following Operations:

- **FILL** – Input water Fill Valve Opens and allows water into tank. Once water reaches Mid-Level Sensor the unit switches to ADD GRANULES Operation.
- **ADD GRANULES** – The indicator light is flashing and the unit is waiting for operator interaction. Once Dry Acid Powder is added the operator is to press START Button. The unit proceeds to the MIX Operation.
- **MIX** – The Mixer Motor turns on for 45 minutes, and then the unit automatically proceeds to DEAERATION Operation.
- **DEAERATION** – The Unit sits motionless to allow excess bubble to rise out of solution for 5 minutes. The unit automatically proceeds to the FINAL FILL Operation.
- **FINAL FILL** – The Unit opens the Fill Valve and Closes the Fill Valve once the Final Fill Sensor is contacted by the rising level in the tank. The program shall continue on to the HOMOGENIZE Operation.
- **HOMOGENIZE** – The Mixer Motor runs to mix the contents of the tank for 10 minutes and then the program continues to the TRANSFER Operation.
- **TRANSFER** – The indicator light is flashing. Unit is waiting for Operator Interaction. Once TRANSFER Operation is complete the program continues to the CYCLE COMPLETE Operation.
- **CYCLE COMPLETE** – The Unit shall sit motionless until next Operator Interaction is initiated.

Rinse Cycle consists of the following Operations:

- **1st FILL** – Input water Fill Valve Opens and allows water into tank. Once water reaches 25-gallon sensor the unit switches to RECIRCULATE Operation.
- **1st RECIRCULATE** – The RECIRCULATE Operation runs for 10 minute period. The spray ball and mixer motor runs for duration of the time. Then, the program continues to DRAIN Operation.
- **1st DRAIN** – In the DRAIN Operation the Unit drains the contents of the tank. Then, the program continues to the 2nd FILL Operation
- **2nd FILL** – Input water Fill Valve Opens and allows water into tank. Once water reaches 25-gallon sensor the unit switches to RECIRCULATE Operation.
- **2nd RECIRCULATE** – The RECIRCULATE Operation continues to run. The spray ball and mixer motor runs for duration of the time. Then, the program continues to DRAIN Operation.
- **2nd DRAIN** – In the DRAIN Operation the Unit drains the contents of the tank. Then, the program continues to CYCLE COMPLETE
- **CYCLE COMPLETE** – The Unit shall sit motionless until Operator Interaction is initiated

* **Stop State, Hold State and Step mode:** For information on the use of Stop, Hold and Step mode refer to Section 9: “Manual Control Operations”

DIAGRAM 2: EXTERNAL AND INTERNAL GRANUFLO I DISSOLUTION UNIT PARTS

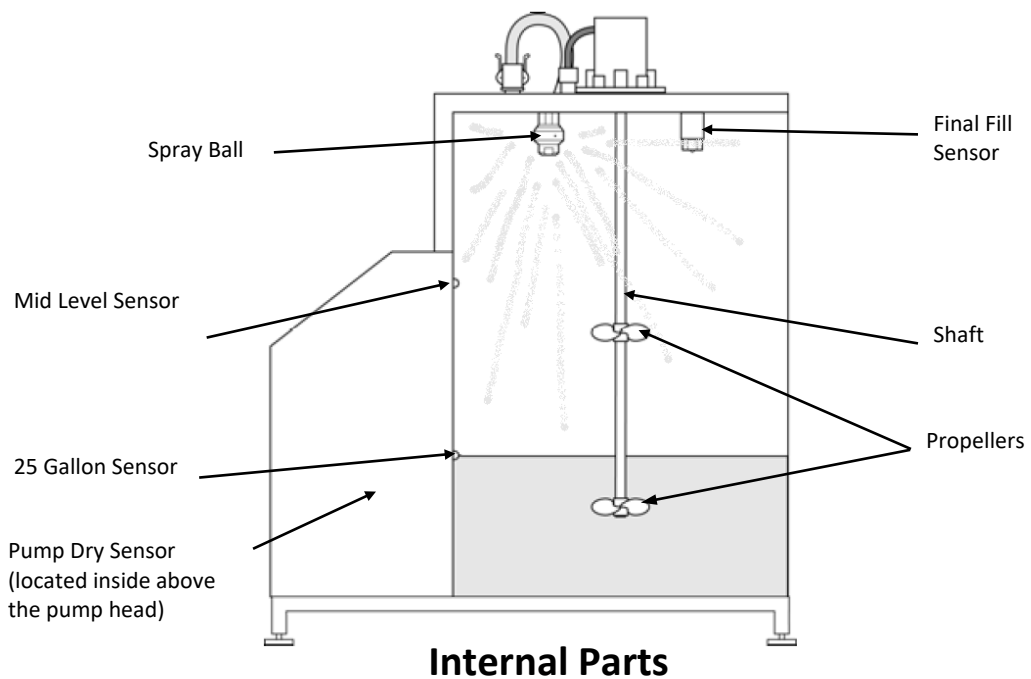
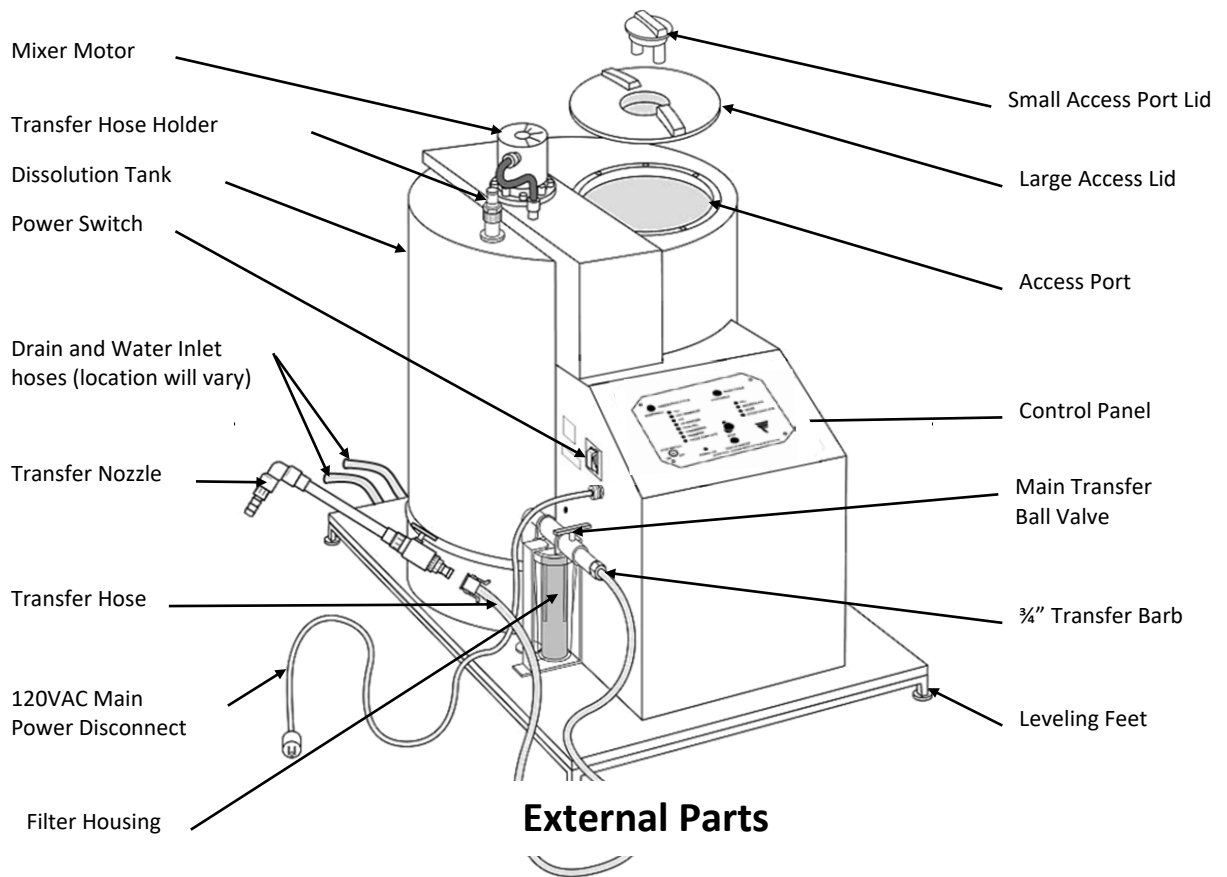

SECTION 5: GRANUFLO DISSOLUTION UNIT PREPARATION

1. Power cord is connected to 120 volts, 60 Hz, single phase, 15 amp; *GFI* protected circuit.
2. Be certain the GranuFlo I Dissolution Unit drain hose is over a floor drain.
3. Ensure Transfer Hose is connected to the Transfer Hose Holder that is on top of GranuFlo I Dissolution Unit.
4. Purified water source is turned ON.
5. Power is in the ON position.



NOTE: INPUT WATER PRESSURE DIRECTLY EFFECTS HOW FAST THE GRANUFLO I DISSOLUTION UNIT WILL FILL. THE MAXIMUM INPUT WATER PRESSURE IS 60 PSI WITH A MINIMUM ½ GALLON PER MINUTE FLOW RATE.

SECTION 6: RINSE CYCLE



CAUTION! BEFORE INITIATING THE RINSE CYCLE, THE DRAIN HOSE MUST BE PLACED ABOVE A SUITABLE DRAIN. ALWAYS LEAVE ACCESS PORT LID IN PLACE UNLESS MANUAL INSTRUCTS OTHERWISE.



CAUTION! IF A GRANUFLO I DISSOLUTION UNIT IS FOUND TO BE STANDING FOR 4 OR MORE HOURS WITH TREATED WATER OR WETTED WITH TREATED WATER, THEN A DISINFECTION CYCLE (SEE SECTION 8.3 SODIUM HYPOCHLORITE (BLEACH) DISINFECTION, PAGE 22) MUST BE COMPLETED BEFORE THE DISSOLUTION CYCLE IS STARTED. IMMEDIATELY AFTER COMPLETED RINSE CYCLE, MAKE A BATCH OF DRY ACID PRODUCT. DO NOT LEAVE THE GRANUFLO I DISSOLUTION UNIT WITH ONLY TREATED WATER OR WETTED WITH ONLY TREATED WATER FOR 4 OR MORE HOURS SINCE THE GRANUFLO I DISSOLUTION UNIT IS SUSCEPTIBLE TO BACTERIAL GROWTH.

1. Before initiating the *RINSE CYCLE*, the operator must ensure that the GranuFlo I Dissolution Unit Access Port Lid is in place (do not fully secure), and the Main Transfer Ball Valve is in the CLOSED position. Make sure the input water source is in the ON position (Figure 1).

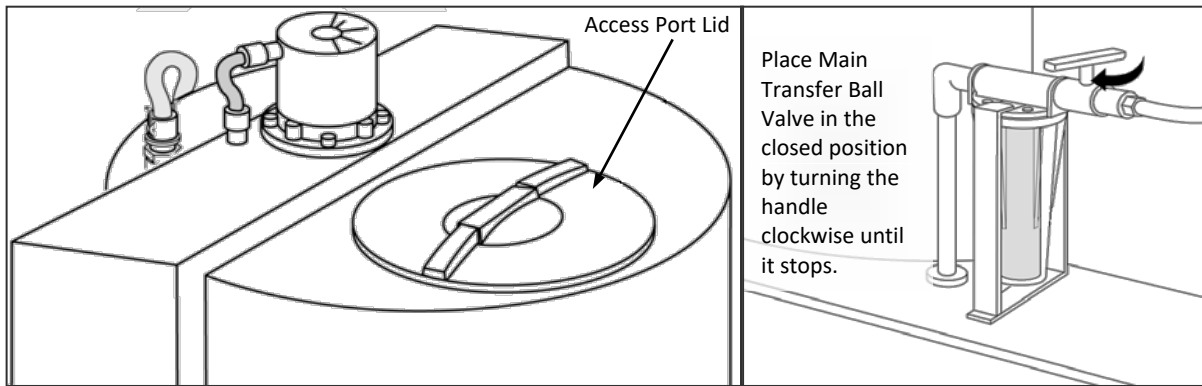

Figure 1

2. The RINSE CYCLE consists of two complete RINSE Operations. Press the Rinse side START/HOLD button. The Fill Indication Light will illuminate indicating the RINSE CYCLE has started and the GranuFlo I Dissolution Unit is in FILL Operation (Figure 2). Verify tank is filling and the water level stops at the 25-Gallon Sensor. Lift the Access Lid and look into the tank to verify that the tank is filling.

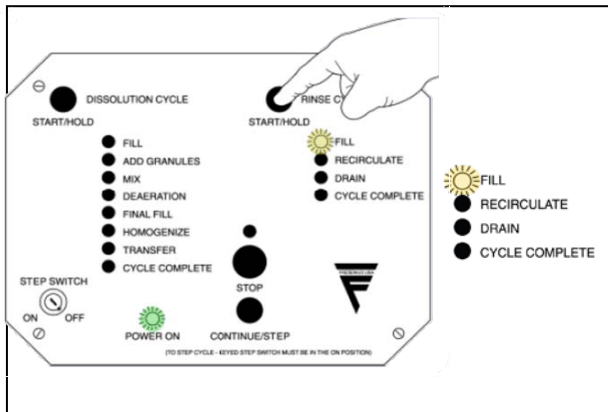

Figure 2

The GranuFlo Dissolution Unit will fill to the 25-Gallon Sensor

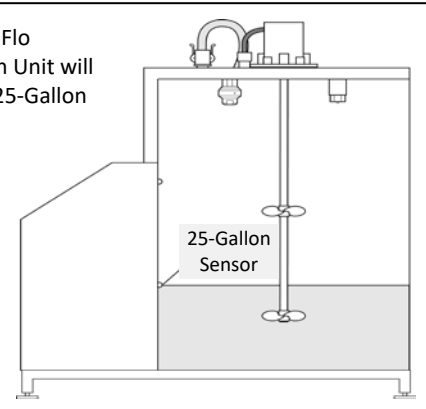
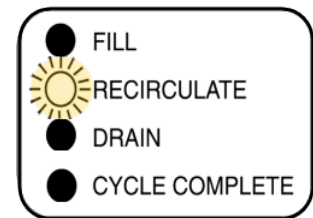

Figure 3

3. Once the 25-Gallon Sensor is reached, the process automatically steps to RECIRCULATE Operation (Figure 3). The pump and the mixer motor shall run for a ten (10) minute period. With your safety glasses on, lift the lid and ensure that the water is level with 25 Gallon Sensor. Since the water shall be swirling in the tank it is okay for the level to be a little above the 25 Gallon Sensor, but ensure that the water level is not rising. During this time period, follow the procedure outlined on the following page to inspect the Spray Ball for correct operation (Figure 4: Spray Ball Inspection/Cleaning Instructions).



4. Inspect and clean the Spray Ball if needed:

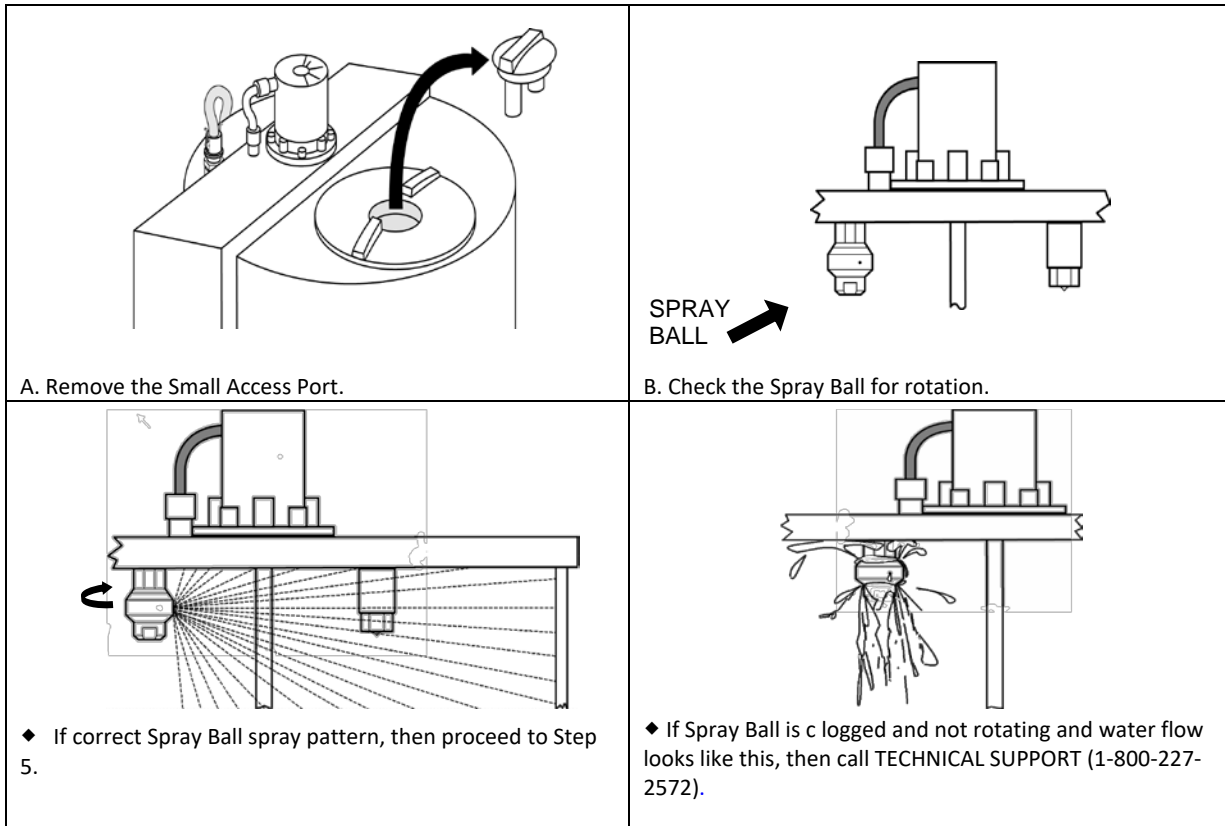
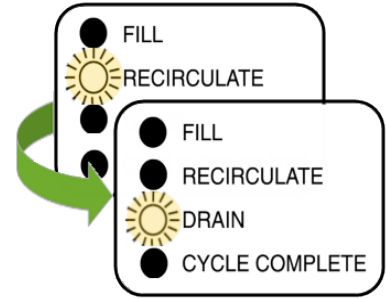
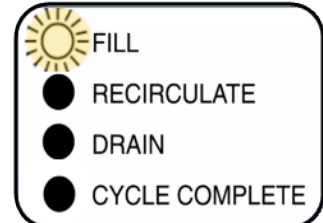

Figure 4: Spray Ball Inspection/Cleaning Instructions

5. When the RECIRCULATE Operation is complete the GranuFlo I Dissolution Unit will switch to DRAIN Operation and empty rinse water from the GranuFlo I Dissolution Unit to the floor drain. This is a ten minute timed cycle.



6. At the completion of the DRAIN Operation, the GranuFlo I Dissolution Unit will refill to the 25-Gallon Sensor. The Fill Indicator Light will turn on and the RINSE Operation will start.



7. When the second RINSE CYCLE is finished, the GranuFlo I Dissolution Unit will go to the CYCLE COMPLETE Operation. The Rinse Cycle Complete Indicator Light will turn ON and the Drain Valve will remain OPEN, allowing any residual rinse water to go down the drain.

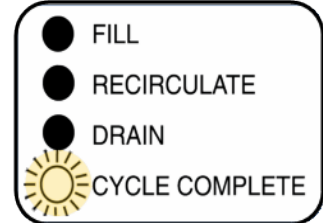



CAUTION! RINSE CYCLE MUST BE COMPLETED PRIOR TO INITIATING BATCH OF CONCENTRATE.

1. Before initiation of *Dissolution Cycle*, ensure the tank is empty, the two (2) propellers are attached to the Mixer Shaft, and the 1 micron filter is installed in the Concentrate Filter Housing (Diagram 2, page 8) by ensuring that there is a filter present. Ensure that the water supplied to the machine is between 20 and 30°C (68 and 86°F) for proper dissolution and mixing. Ensure you have the appropriate personal protective equipment donned. If the filter is not present in the filter housing, refer to Section 8.4.1, Filter Removal and Replacement.
2. Ensure the power switch is ON and water supply valve is in the OPEN position, and then place the GranuFlo I Dissolution Unit in Dissolution Cycle FILL Operation by pressing the Dissolution side START/HOLD button (Figure 5).
3. Gather eight dry acid cases and process documentation accordingly.
4. Mixing of each hemodialysis concentrate batch should be completed in accordance with Form 1, GranuFlo Batch Production Record, page 31.
5. Batch identification should be attached to the GranuFlo I Dissolution Unit.
6. Verify the tank is actually filling. The GranuFlo I Dissolution Unit will be in the FILL Operation until the water reaches to the Mid-Level Sensor.

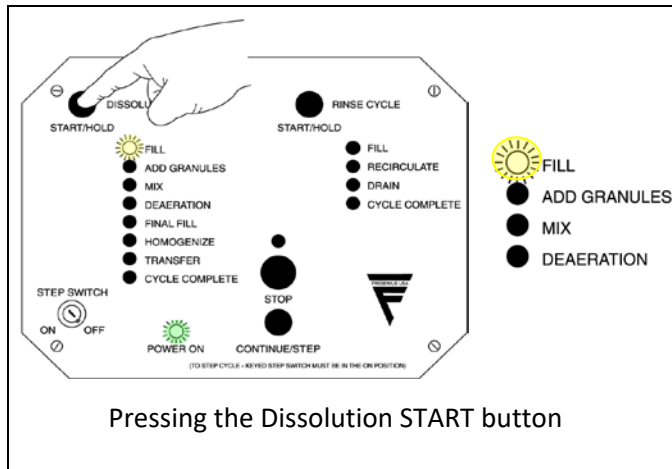

Figure 5

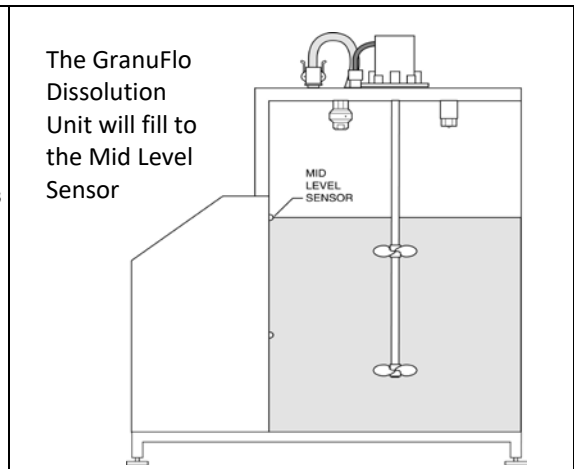
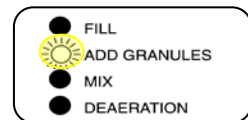

Figure 6

7. When the Mid Water Level is reached (Figure 6), the fill valve will CLOSE and the Add Granules Light will begin to flash.



This flashing light indicates that the GranuFlo I Dissolution Unit is in a hold state waiting for the operator to add the dry acid granules in accordance with the GranuFlo Batch Production Record.



WARNING! IF WATER LEVEL EXCEEDS MID WATER LEVEL DO NOT ADD GRANULES. CALL FRESenius USA, INC, TECHNICAL SUPPORT AT 1-800-227-2572.

8. Before adding dry acid granules make sure to check the following:
 - ◆ Ensure water is not leaking from underneath or any external connections to and from GranuFlo I Dissolution Unit. In addition, ensure there is no leak at the end of the drain hose.
 - ◆ Remove the large access lid and ensure water has stopped at the Mid-Level Sensor (See Figure 6), then place large access lid on top of the access hole loosely.
 - ◆ Ensure you have the appropriate personal protective equipment donned.

Depending on the input water pressure you may have to wait several minutes to verify the water does not rise above the Mid-Level Sensor. Fill in Form 1, the GranuFlo Batch Production Record, page 31.



CAUTION! BE CERTAIN THE SAME CATALOG NUMBER IS ON ALL CASES.



CAUTION! USING EYE PROTECTION, AND GLOVES IS RECOMMENDED. IF CONTACT WITH EYES, RINSE IMMEDIATELY FOR 15 MINUTES. IF CONTACT WITH SKIN, FLUSH WITH PLENTY OF SOAP AND WATER. SEE MATERIAL SAFETY DATA SHEET(MSDS) FOR FURTHER PERSONAL PROTECTIVE EQUIPMENT (PPE) OR EMERGENCY INSTRUCTIONS FOR THE DRY ACID PRODUCT BEING USED.



WARNING! DO NOT USE CASE OF DRY ACID CONCENTRATE THAT HAS BEEN OPENED OR TAMPERED WITH. IT IS IMPORTANT THAT THE ENTIRE CONTENTS OF EACH CASE OF DRY ACID CONCENTRATE IS EMPTIED INTO THE GRANUFLO I DISSOLUTION UNIT. BE CERTAIN ALL BAGS PER CASE HAVE BEEN ADDED.



WARNING! IN ABSENCE OF SIGNIFICANT CLUMPING, ONLY USE THE SMALL ACCESS LID WHEN POURING ACID CONCENTRATE INTO THE MIXER. USE OF THE LARGE ACCESS LID WHEN POURING ACID CONCENTRATE MAY RESULT IN INHALATION INJURY.



NOTE: GRANUFLO® DRY ACID PRODUCT CONTAINS 3 BAGS PER BOX. CONTENTS OF ALL EIGHT BOXES MUST BE POURED INTO THE TANK DURING THE ADD GRANULES OPERATION.



NOTE: INPUT WATER PRESSURE DIRECTLY EFFECTS HOW FAST THE GRANUFLO I DISSOLUTION UNIT WILL FILL. THE MAXIMUM INPUT WATER PRESSURE IS 60 PSI WITH A MINIMUM ½ GALLON PER MINUTE FLOW RATE.

- Remove the GranuFlo I Dissolution Unit Small Access Lid and slowly add granules as seen in Figure 7. This minimizes the amount of particulates discharged into air while adding granules to the tank. If clumping in dry acid product is present, then the larger access lid can be used to load the Tank, but ensure that the bags are slowly poured into the large access port to avoid splashing of water onto the outside of the GranuFlo I Dissolution Unit (See appendix A for further complete dry acid mixing information, page 43).

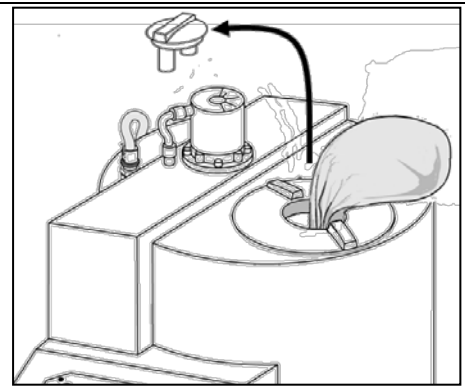

Figure 7

- After the Dry Acid Concentrate has been added, remove the Large Access lid and dry off the Final Fill Sensor of any splashing that may have occurred during the add granules process (Figure 8).

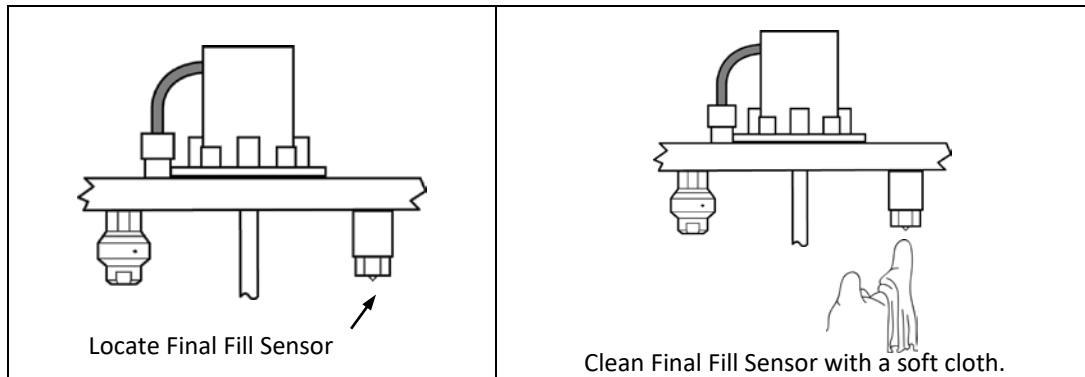
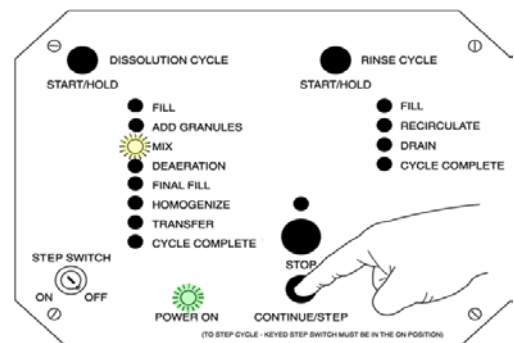

Figure 8

- Replace the Large and Small Access Lid then press the CONTINUE/STEP button.

The GranuFlo I Dissolution Unit will proceed to the MIX Operation.



12. During the MIX Operation, the solution is mixed for a period of forty-five (45) minutes allowing the granules to completely dissolve. The GranuFlo I Dissolution Unit will then automatically step to the DEAERATION Operation.

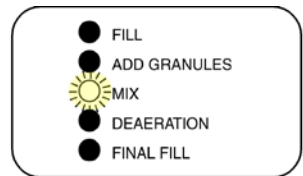

13. The DEAERATION Operation is five (5) minutes during which the entrapped air is allowed to separate out of the solution. Upon completion, the GranuFlo I Dissolution Unit will automatically step to FINAL FILL Operation and the Final Fill Indicator Light will illuminate.

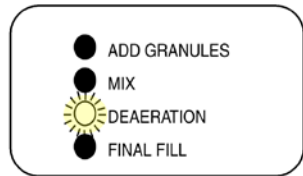

14. In the FINAL FILL Operation, the fill valve will OPEN and GranuFlo I Dissolution Unit will fill to the final water level.

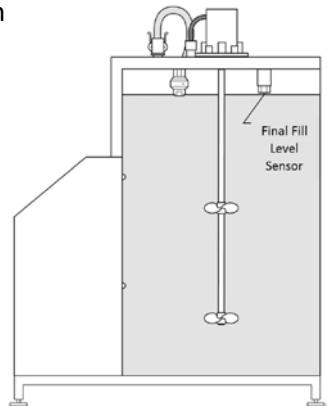
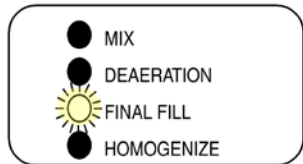

15. When the final water level is reached, the unit will automatically step to HOMOGENIZE Operation. Verify the solution level is touching Final Fill Sensor. CLOSE the water supply valve to the GranuFlo I Dissolution Unit.

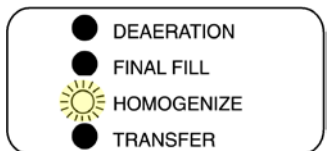

16. During HOMOGENIZE Operation, the Mixer will mix the solution for ten (10) minutes. When the HOMOGENIZE Operation is complete, the Transfer Indicator Light will flash. Remove Large Access Lid and look into the tank to make sure the granules have dissolved and the solution is colorless.

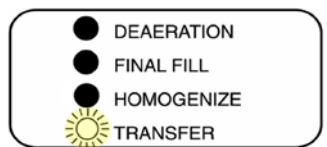

17. Once you have verified the granules are dissolved and the solution is colorless, the solution is ready for Specific Gravity Testing. If the granules have not dissolved and/or the solution is not colorless, call Technical Service (1-800-227-2572) for further instructions.



NOTE: DO NOT PLACE A HYDROMETER INTO THE GRANUFLO I DISSOLUTION UNIT AT ANY TIME.



WARNING: SPECIFIC GRAVITY TEST MUST BE PERFORMED AFTER EVERY BATCH OF CONCENTRATE THAT IS MADE. IN ADDITION, CONCENTRATE SAMPLES SHOULD BE TAKEN FROM THE TRANSFER HOSE ONLY.

7.1 TRANSFER HOSE FLUSH AND SPECIFIC GRAVITY TEST:

Once the Transfer Indicator Light flashes, the concentrate is ready to be tested. This test is done using a *hydrometer* which measures the density of the acid concentrate. The resultant value is called the "specific gravity". The specific gravity is measured to verify that the concentrate has been properly mixed.



WARNING! ALWAYS CHECK THE SPECIFIC GRAVITY OF EACH NEW BATCH OF ACID CONCENTRATE BEFORE USING IN TREATMENT. SUPPLYING AN IMPROPERLY MIXED ACID CONCENTRATE TO THE HEMODIALYSIS MACHINE MAY RESULT IN PATIENT INJURY OR DEATH.

To determine a Specific Gravity Reading:

1. Prepare the hydrometer and the Hydrometer Cylinder
 - Check the hydrometer for cracks. Do not use a cracked Hydrometer.
 - Always handle the hydrometer with care. Always hold it vertically by the top, as finger marks lower down can affect the accuracy of the instrument.
 - The hydrometer should never be held by the stem horizontally.
 - Rinse the hydrometer and the hydrometer cylinder separately with purified water before checking solution for specific gravity. The purified water source must meet *ANSI/AAMI* or *ISO* standards for dialysis currently *ANSI/AAMI RD62*, or *ISO 13959*.
 - Once hydrometer is clean, place the *hydrometer* onto a clean area.

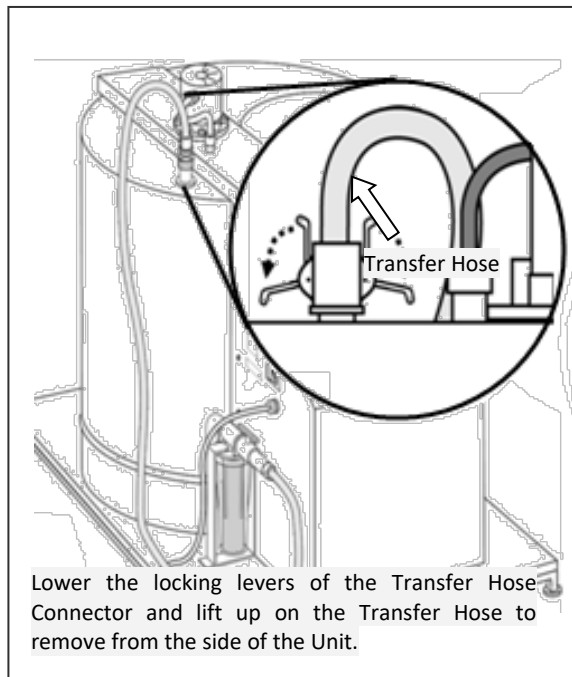

Figure 9

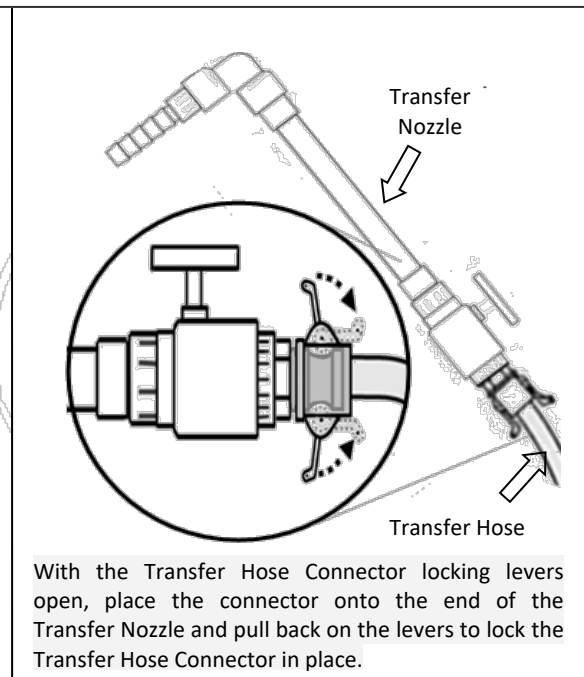

Figure 10

2. Remove Transfer Hose from the top of the tank (Figure 9) and connect the Transfer Hose to the Transfer Nozzle (Figure 10).
3. Hold the Transfer Nozzle and make sure the Ball Valve on the Transfer Nozzle is CLOSED (Figure 11).

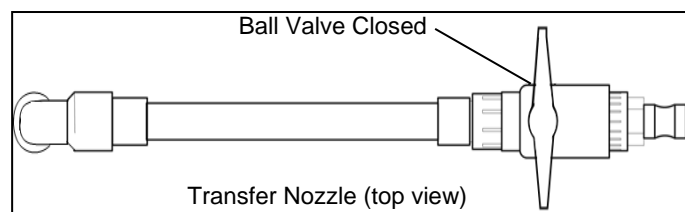

Figure 11

4. Slightly OPEN the Main Transfer Ball Valve next to the Filter Housing (Figure 12, item A).
5. Flush the transfer hose:



WARNING! FAILURE TO FLUSH THE TRANSFER HOSE WITH 3.5 GALLONS PRIOR TO MEASURING SPECIFIC GRAVITY MAY RESULT IN AN INCORRECT SPECIFIC GRAVITY READING, AND/OR SUPPLY OF AN INCORRECT CONCENTRATE FORMULATION TO THE HEMODIALYSIS MACHINE, WHICH MAY RESULT IN PATIENT INJURY OR DEATH.



WARNING! THE FLUSH SOLUTION IS A MIXTURE OF CONCENTRATE FROM THE PREVIOUS BATCH AND THE NEW BATCH. THE COMPOSITION OF THE FLUSH SOLUTION MUST BE CONSIDERED WHEN DETERMINING CLINIC POLICIES FOR DISPOSITION OF THE FLUSH SOLUTION. SUPPLY OF AN INCORRECT CONCENTRATE FORMULATION TO THE HEMODIALYSIS MACHINE MAY RESULT IN PATIENT INJURY OR DEATH.

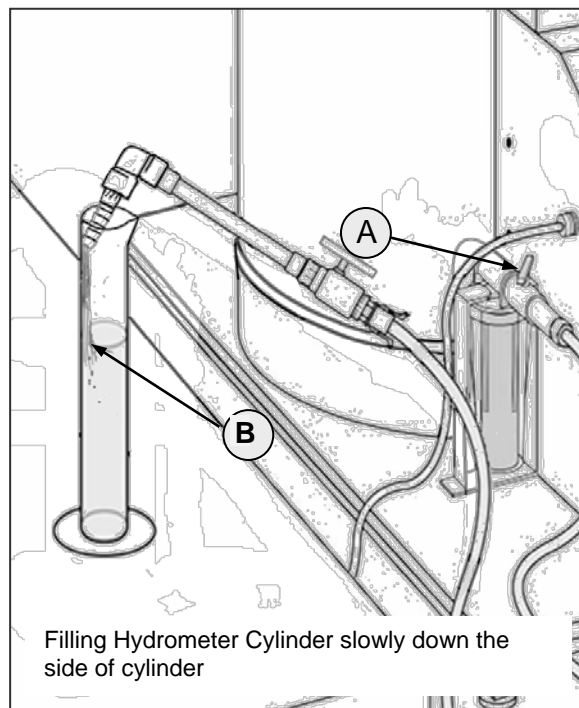

Figure 12

Press Dissolution START/HOLD button, slightly open Transfer Nozzle Valve and flush approximately 3.5 gallons of solution.

- Once the 3.5 gallons of solution have been flushed out of the transfer hose, CLOSE the Transfer Nozzle.
 - Disposition the flushed solution according to clinic policies and procedures.
6. Fill the Hydrometer Cylinder:
 - Insert the Transfer Nozzle into the Hydrometer Cylinder.
 - Slowly OPEN the Transfer Nozzle Valve until solution starts to slowly accumulate into the Hydrometer Cylinder. Allowing solution to fill down the side of the beaker minimizes the creation of bubbles within the solution (Figure 12, item B).
 - Fill the Hydrometer Cylinder approximately 2/3 rd full.
 - CLOSE Transfer Nozzle and then press STOP button on the Display Panel.
 - Place Transfer Nozzle onto a clean surface.
 7. Make sure the solution you gathered does not have excessive amount of bubbles. To release excess amount of bubbles from the solution gently tap the Hydrometer Cylinder or gently swirl the entire Hydrometer Cylinder until bubbles have been released from the solution (Figure 13).

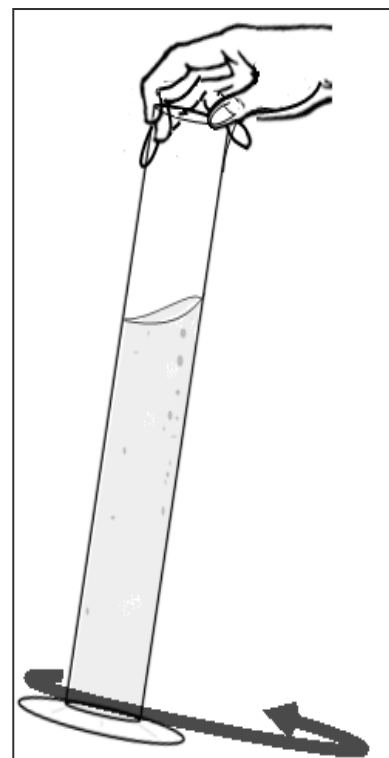

Figure 13

8. Measure Temperature:

- Place Hydrometer Cylinder on a level table and using a Thermometer measure the temperature of the solution in the Hydrometer Cylinder immediately (Figure 14A).
- For Thermometer requirements refer to Form 1. The measurement of the temperature collected during this step will be known as the *measured temperature* of the solution and will be required on the next step.



WARNING: IN ORDER TO ACCURATELY DETERMINE IF THE ACID CONCENTRATE HAS BEEN PREPARED CORRECTLY, THE TEMPERATURE OF THE SOLUTION MUST BE MEASURED AND THE SPECIFIC GRAVITIES TABLE IN FORM 1 (GRANUFLO) MUST BE CONSULTED. SUPPLYING AN INCORRECTLY PREPARED ACID CONCENTRATE TO THE HEMODIALYSIS MACHINE MAY RESULT IN PATIENT INJURY OR DEATH.

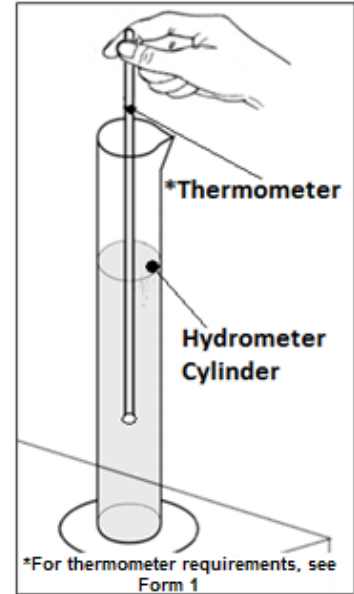

Figure 14A

9. Depending on what Dry Acid Product is being used, go to Form 1:

GranuFlo Dry Acid Specific Gravities Table, page 31:

- Locate the Catalog number of the dry acid product being used.
 - Using the *measured temperature* from step 8, locate the value of the measured temperature of the solution in the table.
 - Moving across and then down, identify the 'low' and 'high' specific gravity numbers.
 - These 'low' and 'high' numbers can be recorded in the appropriate box in the GranuFlo Batch Production Record, page 31.
 - Record the *measured temperature* in the appropriate box in the GranuFlo Batch Production Record Form , page 31.
- Obtain the clean hydrometer and measure the specific gravity of the solution in the Hydrometer Cylinder.
 - If the hydrometer or the surface of the solution is not clean, discard the contents of the hydrometer cylinder into the Residual Solution Bucket. Clean the hydrometer and the hydrometer cylinder and restart from Section 7.1, #6, page 17.
 - Do not take a reading if the hydrometer is touching the side of the Hydrometer Cylinder.
 - Document the Specific Gravity in the Batch Production Record Form in the "Measured Specific Gravity Value" box.
 - If the actual *Specific Gravity* value that you measured falls within the 'low' and 'high' range on the Batch Record Production Form, then the value is acceptable, the solution can be used and its ready for TRANSFER Operation. Prior to Transfer Batch Record Form must checked for completeness and signed off by qualified reviewer. Place the solution in the Hydrometer Cylinder into the Residual Solution Bucket. Rinse the hydrometer cylinder and the hydrometer before storing equipment. To dispose the solution in the Residual Solution Bucket, See section 13.1: *Residual Solution Disposal or Disposition*, page 41.
 - If the actual *Specific Gravity* value does not fall with in the 'low' and 'high' range, then the entire batch must be disposed, See Section 13.2: Tank Disposal, page 41.
 - Complete the documentation on the Batch Production Record and obtain reviewer's signature for the batch prepared before transfer.



WARNING! DO NOT USE THE CONCENTRATE IF THE *SPECIFIC GRAVITY* IS NOT WITHIN THE EXPECTED RANGE. IF CONCENTRATE IS NOT WITHIN EXPECTED RANGE DISCARD THE ENTIRE BATCH. ONCE THE SOLUTION IS REMOVED, RESTART FROM SECTION 7, PAGE 14.



NOTE: CONCENTRATE SOLUTION MUST BE DISPOSED OF IN ACCORDANCE WITH LOCAL, STATE, AND FEDERAL REQUIREMENTS. IF YOU HAVE QUESTIONS REGARDING THE DISPOSAL OF CONCENTRATE SOLUTION, THEN SEE SECTION 13: DISPOSAL OF CONCENTRATE SOLUTION, PAGE 41, FOR FURTHER INSTRUCTIONS.



WARNING! NEVER ADD WATER OR ADDITIONAL DRY ACID PRODUCT TO OBTAIN THE CORRECT SOLUTION SPECIFIC DENSITY.

7.2 TRANSFER TO STORAGE TANK:



CAUTION! COMPARE THE CATALOG NUMBER ON THE STORAGE TANK WITH THE CATALOG NUMBER ON THE DRY ACID CASE TO BE CERTAIN THEY ARE THE SAME.

1. After you obtain a valid *specific gravity* reading, remove the Transfer Hose from the Transfer Nozzle.
2. Connect Transfer Hose to the storage tank and OPEN Main Transfer Ball Valve at the side of the Filter Housing. Press the CONTINUE/STEP button to transfer concentrate into the storage tank (Figure 14).

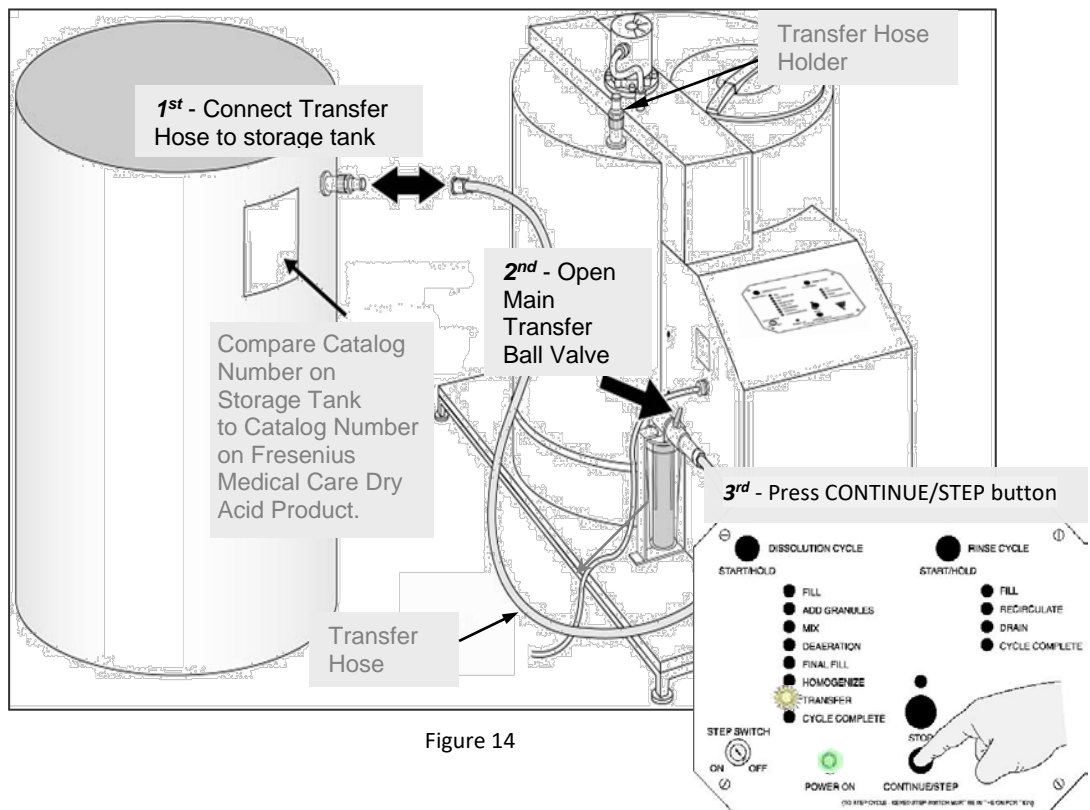

Figure 14

3. Once Transfer of solution is complete, CLOSE the Main Transfer Ball Valve and place Transfer Hose onto the GranuFlo I Dissolution Unit Transfer Hose Holder. Do not leave Transfer Hose attached to the Storage Tank (see Figure 18).



CAUTION! IF THE PUMP IS RUN DRY FOR LONGER THAN 30 SECONDS IT MAY CAUSE PUMP FAILURE.

7.3 TRANSFER TO INDIVIDUAL CONTAINER:

1. To transfer product into individual containers (containers must be properly labeled):

1st Connect the Transfer Hose to the Transfer Nozzle.

2nd Place the Transfer Nozzle into the opening of an individual container

3rd Slightly OPEN the Main Transfer Ball Valve on the top of the Filter Housing.

4th With the Transfer Light flashing, Press Dissolution CONTINUE/STEP button. The Transfer Pump will start.

5th Slowly OPEN Ball Valve on the Transfer Nozzle until the desired rate of flow through the nozzle is achieved.

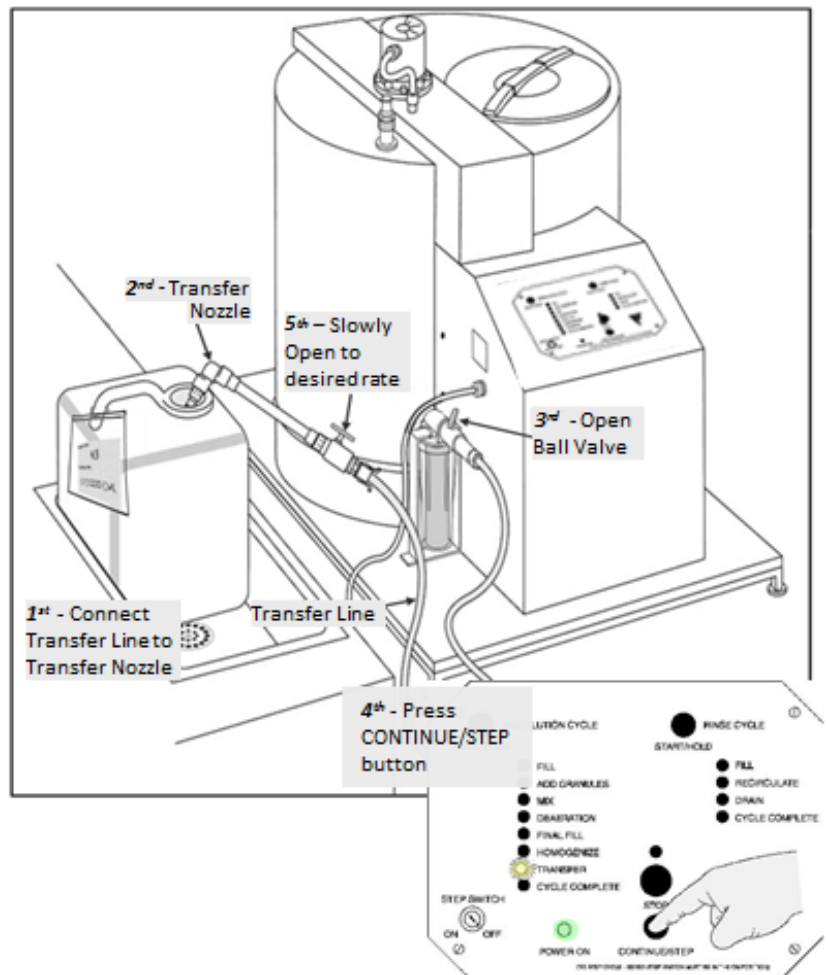

2. Once the manual TRANSFER Operation has been completed and the individual containers are filled, CLOSE Transfer Nozzle Valve. Press the STOP button.

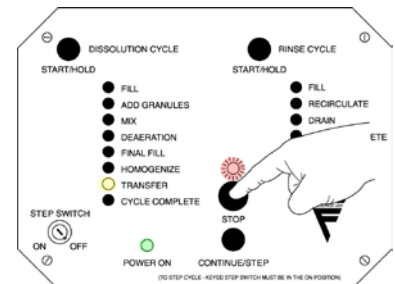

3. When the GranuFlo I Dissolution Unit is empty, the GranuFlo I Dissolution Unit will step to the CYCLE COMPLETE Operation. CLOSE the GranuFlo I Dissolution Unit's Main Transfer Ball Valve. Then Remove Transfer Nozzle and place Transfer Hose onto the Transfer Hose Holder of the Tank. Ensure you place the Transfer Nozzle in appropriate area free from dirt and other contaminants.

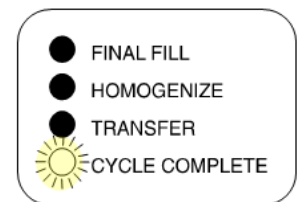

CAUTION! IF THE PUMP IS RUN DRY FOR LONGER THAN 30 SECONDS THIS MAY CAUSE PUMP FAILURE.



NOTE: ACID CONCENTRATE SHOULD NOT BE STORED IN MIX TANK LONGER THAN 14 DAYS FROM THE DATE OF MIXING. ACID CONCENTRATE MAY BE STORED FOR LONGER PERIODS IN APPROVED CONTAINERS UNDER PROPER STORAGE CONDITIONS.



WARNING! TO PREVENT ACCIDENTAL SHOCK HAZARD, THIS DEVICE MUST BE PLUGGED INTO A PROPERLY GROUNDED *GFI* PROTECTED THREE WIRE RECEPTACLE AC CIRCUIT. DO NOT EMPLOY EXTENSION CORDS OF ANY KIND. WHEN THE POWER CORD IS NOT LONG ENOUGH TO BE SERVICEABLE, A LICENSED ELECTRICIAN MUST INSTALL A NEW THREE WIRE GROUNDED RECEPTACLE IN ACCORDANCE WITH THE NATIONAL ELECTRICAL CODE. DO NOT USE A THREE TO TWO PRONG PLUG ADAPTER WITH THIS DEVICE.

The GranuFlo I Dissolution Unit has been designed for ease of use and trouble free operation. However, a minimal amount of preventive maintenance is required in order to maintain the GranuFlo I Dissolution Unit in good working condition and minimize the possibility of a system malfunction.

The recommended program for proper care of the GranuFlo I Dissolution Unit consists of four basic steps. They are: (8.1) Regular visual inspection, (8.2) Cleaning (8.3) Sodium Hypochlorite (Bleach) Disinfection and (8.4) Filter Maintenance.

8.1 VISUAL INSPECTION

Visually inspect the GranuFlo I Dissolution Unit prior to mixing a batch. The operator should look for any defects which may inhibit the safe or proper operation of the Unit. Items such as damaged hydraulic hoses or fittings, damaged electrical cables or connections, loose, missing or damaged hardware or process contamination should be corrected prior to the use of the GranuFlo I Dissolution Unit.

Should the power cord or plug become cracked, frayed or otherwise damaged, it should be replaced immediately. Tag unit "OUT of SERVICE" until the repair is made. Always remove the power cord from the power source before attempting to service this device. Never unplug the unit by pulling on the power cord.

8.2 CLEANING

Clean the exterior surface of the GranuFlo I Dissolution Unit thoroughly after each batch of concentrate is mixed. If necessary, a mild detergent solution may be used to clean the exterior surface. Care should be taken not to contaminate the system interior. All spills should be wiped off immediately. Spillage at the control panel should be avoided in order to minimize the possibility of electrical malfunction.

8.2.1 PREVENTIVE MAINTENANCE:

See **Table 1: Routine Maintenance Schedule** on page 29.



CAUTION! DO NOT USE CHEMICAL CLEANING AGENTS THAT MAY DAMAGE THE MATERIAL USED IN THE GRANUFLO I DISSOLUTION UNIT. AGENTS WHICH CONTAIN *BENZENE*, *TOLUENE*, *XYLENE*, *ACETONE* OR ANY OTHER *AROMATIC* OR *KETONE* SOLVENTS MUST BE AVOIDED.

8.3 SODIUM HYPOCHLORITE (REGULAR BLEACH) DISINFECTION



NOTE: USE ONLY 5% TO 10% SODIUM HYPOCHLORITE (REGULAR BLEACH) TO DISINFECT THE GRANUFLO I DISSOLUTION UNIT.



WARNING! ENSURE THE TRANSFER HOSE IS NOT CONNECTED TO A CONCENTRATE STORAGE CONTAINER/TANK.

1. To start the disinfection process, power OFF the GranuFlo I Dissolution Unit, remove the Filter Housing and discard the Filter Element. Place the residual fluid from the Filter housing in the *Residual Solution Bucket*. Reinstall Filter Housing, but do not insert a Filter at this time. Connect the Transfer Nozzle to the end of the Dissolution Unit's Transfer Hose and make sure the valve on the Transfer Nozzle is in the CLOSED position. In addition, loosen the top Access Lid, but leave it in place. Ensure you have the appropriate personal protective equipment donned.



NOTE: A RINSE CYCLE CONTAINS TWO RINSE OPERATIONS THAT RUN IN SEQUENCE WITHIN ONE COMPLETE RINSE CYCLE. THE 1ST RINSE OPERATION CONSISTS OF FILL, RECIRCULATION, AND DRAIN. 2ND RINSE OPERATION CONSISTS OF FILL, RECIRCULATION, DRAIN, AND CYCLE COMPLETE.

2. Turn the power switch ON and ensure that the water supply valve is OPEN then press the Rinse START/HOLD button. The Fill Indicator LIGHT will illuminate indicating the RINSE CYCLE has started and the GranuFlo I Dissolution Unit is in the first FILL Operation (Figure 19).

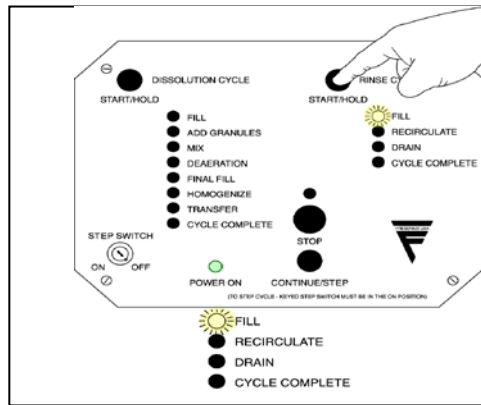

Figure 19

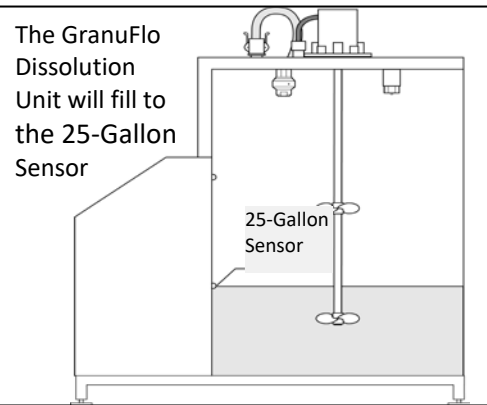

Figure 20

3. Once the 25-Gallon Sensor is reached, the control panel will automatically step to the first RECIRCULATE Operation (figure 20). With your safety glasses on, lift the Access lid and check for correct spray ball operation. See figure 4, page 12, for the illustration of correct or incorrect spray ball operation.
4. When the Fill Indicator Light switches to the Recirculate Indicator Light during the second RINSE Operation, pause the RINSE CYCLE by pressing the STOP button (the red indicator light will turn ON), then add 0.5 gallons (1.9 liters) of regular bleach (sodium hypochlorite 5% to 10%) to the rinse water in the tank. Once the 0.5 gallons of regular bleach is added, press the CONTINUE/STEP button (the red indicator light will turn OFF) and the RINSE Operation will continue for the duration of the 2nd RINSE Operation.
5. Once the Dissolution Unit is in the RINSE CYCLE's CYCLE COMPLETE Operation mode, initiate and complete two RINSE CYCLES consecutively by following the steps in Section 6, page 11.
6. When the two RINSE CYCLES are complete, the unit should be in the RINSE CYCLE, CYCLE COMPLETE Operation. Use the appropriate chlorine test strips to check for the proper chlorine level at the two outputs of the GranuFlo I Dissolution Unit (transfer hose and drain hose).
7. Checking bleach residuals from the Transfer hose.
 - Press DISSOLUTION CYCLE side START button.
 - When water has reached the 25 Gallon Sensor, rotate the STEP SWITCH key to the ON position.
 - Press the CONTINUE/STEP button to step to TRANSFER Operation, the Transfer Indicator Light will be flashing.
 - Have chlorine test strip ready for use
 - Rotate the STEP SWITCH key to the OFF position. The TRANSFER Indicator Light will stop flashing, the Transfer Valve will OPEN and the Pump will turn ON.
 - OPEN the Main Transfer Ball Valve on the GranuFlo I Dissolution Unit.
 - With the end of the Transfer Nozzle placed over a drain, slowly OPEN the valve on the Transfer Nozzle. Allow water to flow to the drain for 15 seconds.
 - Adjust the output of the Transfer Nozzle to a slow output flow.

- Place test strip under the flow for 30 seconds or the time interval recommended by the manufacture of the test strip being used.
 - Close Transfer Nozzle Valve and press the STOP button (the red indicator light will illuminate).
 - Ensure that you check the results of the test strip immediately. If the results are higher than 0.1 ppm (RD61: 2006) go to step 9.
 - Before proceeding to step 8, ensure the Drain Hose is secure to prevent the hose from flailing around during the DRAIN Operation.
8. Checking bleach residuals during DRAIN Operation from the drain hose.
 - Have chlorine test strip ready for use.
 - Rotate the STEP SWITCH KEY to the ON position and then press the CONTINUE/STEP button to step to the DRAIN Operation.
 - To Start the DRAIN Operation, rotate the STEP SWITCH KEY to the OFF position.
 - The red Indicator Light will turn OFF and the Drain Valve will OPEN. Allow water to drain for 30 sec.
 - Place test strip under the flow for 30 seconds or the recommended time on the test strip manufacture’s instruction. Press STOP button once you are complete with this step.
 - Ensure that you check the results of the test strip immediately.
 9. If residual bleach levels are higher than *ANSI/AAMI* Standard limit of <0.1 ppm (RD61: 2006), in any of the two testing regions initiate another complete RINSE CYCLE. After the RINSE CYCLE is complete, start from section 8.3, #5, to check for residual bleach. Continue the RINSE CYCLE and test procedure until bleach residuals are within *ANSI/AAMI* Standard limit of <0.1 ppm (RD61:2006) at the end of the Transfer and Drain Hose.
 10. Once you have attained an acceptable bleach residual reading, ensure the Mixing Tank is empty, power to the GranuFlo I Dissolution Unit has been turned off and CLOSE the Main Transfer Ball Valve near the filter housing. Then, connect the Transfer Hose back onto the GranuFlo I Dissolution Unit Transfer Hose Holder (See Diagram 2: GranuFlo I Dissolution Unit, page 8).
 11. Remove Filter Housing and drain all residual water from the Housing. Install new Filter and tighten Filter Housing into place (Figure 21).

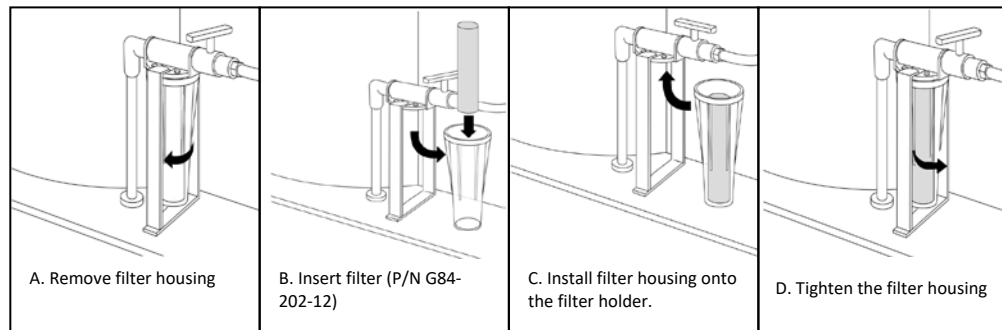

Figure 21

12. Immediately after RINSE CYCLE, make a batch of Dry Acid Product using Section 7, page 14. Leaving the GranuFlo I Dissolution Unit with only treated water or wetted with only treated water leaves the Unit susceptible to bacterial growth.



CAUTION! DO NOT ALLOW THE UNIT TO REMAIN FULL OF WATER WITHOUT THE ADDITION OF FRESENIUS MEDICAL CARE DRY ACID PRODUCT. BACTERIAL GROWTH MAY OCCUR.

8.4. FILTER MAINTENANCE

The 1-micron filter should be changed under the following conditions:

1. The Filter should be changed after mixing 6 batches.
2. When the GranuFlo I Dissolution Unit requires disinfection.

8.4.1. FILTER REMOVAL AND REPLACEMENT

Ensure the Mixing Tank is empty and that power to the GranuFlo I Dissolution Unit has been turned off and the MAIN TRANSFER BALL VALVE is CLOSED. Follow the Figure A, B, C, and D for removal and replacement of the filter (Figure 22). If the residual fluid in the Filter housing is concentrate, then place the solution in the *Residual Solution Bucket*.

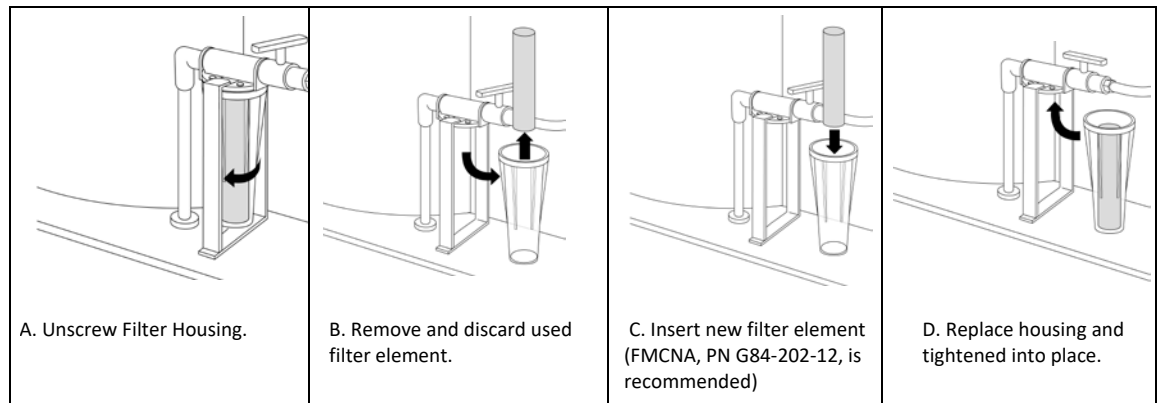

Figure 22



NOTE: THE FILTER USED MUST BE COMPATIBLE WITH FRESENIUS MEDICAL CARE DRY ACID PRODUCT AND RATED AT 1 MICRON. FRESENIUS MEDICAL CARE. P/N G84-202-12 IS A POLYPROPYLENE FIBER WOUND ON A POLYPROPYLENE MESH CORE AND MEETS THESE REQUIREMENTS. CELLULOSE FILTERS ARE NOT COMPATIBLE WITH THE FRESENIUS MEDICAL CARE DRY ACID PRODUCT.



NOTE: IT IS RECOMMENDED TO REPLACE THE FILTER AFTER MIXING 6 BATCHES OR IF THE TANK REQUIRES DISINFECTION.

8.5. SENSOR REPLACEMENT

An authorized Fresenius Medical Care Service Technician will replace the existing sensor with a calibrated sensor. Assure proper concentrate composition after replacement with hydrometer.



NOTE: IF THE FINAL FILL SENSOR NEEDS ADJUSTMENT OR REPLACEMENT, THEN A QUALIFIED TECHNICAL PERSONNEL SHALL COMPLETE THIS AND THE FOLLOWING TASKS. SAMPLE MUST BE DRAWN FROM THE FIRST BATCH OF CONCENTRATE MIXED. THIS SAMPLE MUST BE ANALYZED FOR CORRECT SOLUTION MIX BEFORE THE CONCENTRATE CAN BE USED. BEFORE REPLACING THE FINAL FILL SENSOR OR RELOCATING THE GRANUFLO I DISSOLUTION UNIT CONTACT FRESENIUS MEDICAL CARE TECHNICAL SERVICE AT 1 (800) 227-2572 AND REQUEST TWO (2) EMPTY SAMPLE BOTTLES (P/N G83-535-02). SEE APPENDIX B, PAGE 51, FOR FURTHER INSTRUCTIONS.

9.1 HOLD STATE

To allow for special occurrences, and to allow some latitude in the operation of the Fresenius Medical Care Dissolution Unit, a HOLD state has been included in the control system.

If at any time the operator needs to HOLD a timed process during the cycle, the START/HOLD button may be pressed.

This will cause the Indicating Light for the current step of the process to flash. Any equipment in operation, such as the Agitator or Pumps will continue to operate. In the HOLD state only the timers are stopped. To continue the cycle, press the CONTINUE/STEP button and the timers will resume.

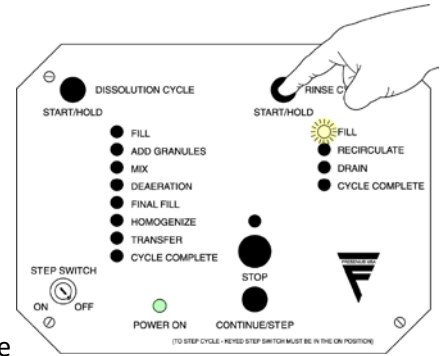

9.2 STOP STATE

The STOP State function is to allow for special occurrences in the operation of the GranuFlo I Dissolution Unit. For example; if the unit is not working properly or the operator needs to PAUSE a timed operation, then the STOP button may be pressed.

The STOP Button has been provided to allow the operator to stop the process. When the STOP Button is pressed, the red Indicator Light will turn ON and the current status light will flash, indicating a STOP state. All operations will stop such as pumps, agitators, drains, fill valves, etc.

The process may be resumed by pressing the CONTINUE/STEP Button.

The FILL Operation cannot be stopped.

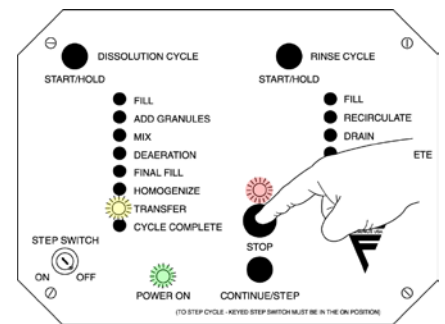

CAUTION! DO NOT ALLOW THE UNIT TO REMAIN FULL OF WATER WITHOUT THE ADDITION OF DRY ACID PRODUCT. BACTERIAL GROWTH MAY OCCUR.

9.3 STEP MODE



CAUTION! STEP MODE FUNCTION IS NOT TO BE USED TO SPEED UP THE DISSOLUTION OR RINSE OPERATIONS.

The STEP MODE function is intended to be used during the Disinfection Operation or when it is necessary to discard an incorrectly mixed batch of solution. The STEP MODE function has the ability to skip critical steps in the Dissolution and Rinse Cycles but using this mode during these cycles can cause unintended operation of the GranuFlo I Dissolution Unit resulting in an incorrectly mixed solution.

To enter the STEP MODE rotate the STEP SWITCH key to the ON position. The system will enter the STEP MODE and all operations will be suspended.

Press the CONTINUE/STEP Button to step to the desired operation. Allow at least five seconds between each step to allow valves to completely open or close. When the desired operation light becomes illuminated, turn the STEP SWITCH key to the OFF position and the operation is continued.

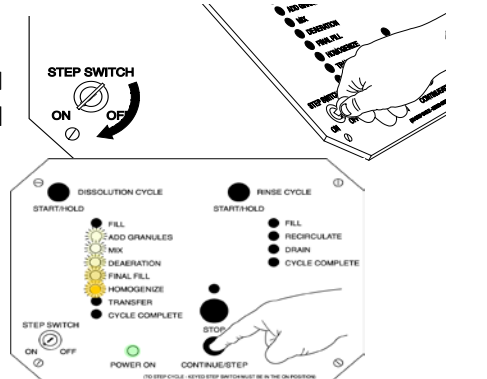

CAUTION! WHEN THE STEP Light IS OFF, THE GRANUFLO I DISSOLUTION UNIT WILL RESUME OPERATION.

9.4 MAIN POWER DISCONNECT

The MAIN POWER Switch is provided to allow the operator to completely shut down the power to the GranuFlo I Dissolution Unit. The Main Power Disconnect Switch should be switched to the OFF position when the GranuFlo I Dissolution Unit is not in use or in case of an emergency.

Remove POWER PLUG from wall receptacle to disconnect power. A 'LOCKOUT' device may be used to prevent unauthorized start up.

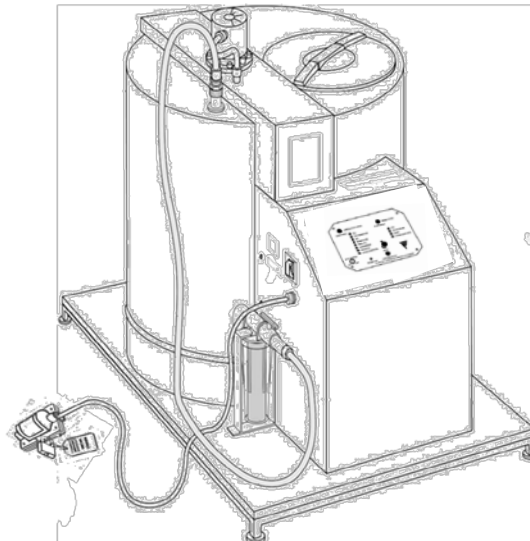

NOTE: WHEN POWER IS RESTORED TO THE GRANUFLO I DISSOLUTION UNIT, SUCH AS AFTER USE OF THE MAIN POWER SWITCH, OR A POWER FAILURE, THE GRANUFLO I DISSOLUTION UNIT WILL RESUME THE OPERATION THAT WAS IN OPERATION AT THE TIME OF THE INTERRUPTION, AFTER THE OPERATOR HAS PRESSED THE START BUTTON.

PRESSING THE PAUSE BUTTON OR PLACING THE CONTROL INTO THE STEP MODE WILL DISABLE THE PUMPS, AGITATORS, DRAINS, FILL VALVES, ETC.

DIAGRAM 3: HYDRAULIC/ELECTRICAL

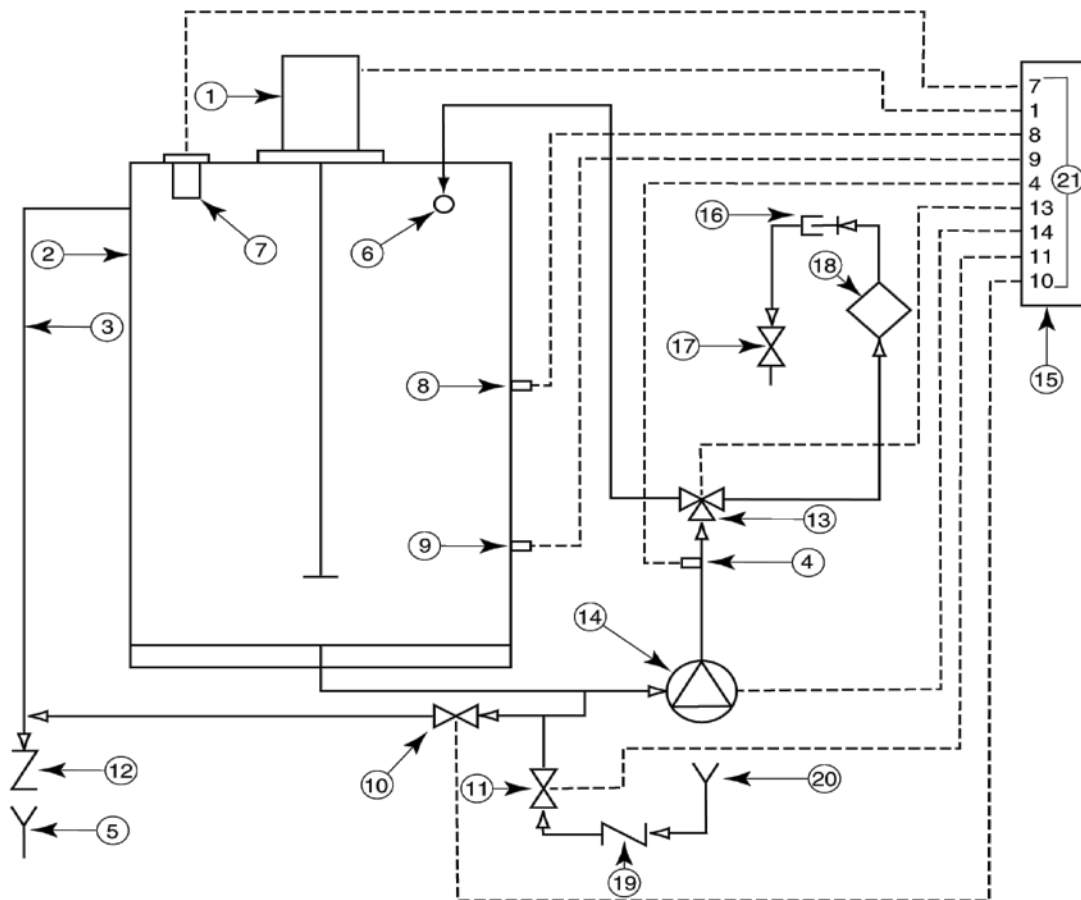

- | | |
|------------------------------------|---|
| 1. Mixer Motor | 12. Check Valve (Drain) |
| 2. Dissolution Holding Tank | 13. Recirculate/Transfer Valve |
| 3. Overflow Pipe | 14. Pump |
| 4. Pump Dry Sensor (Pump Shut off) | 15. Control Box |
| 5. Main Drain | 16. Transfer Hose outlet |
| 6. Spray Ball | 17. Transfer Nozzle (Optional) |
| 7. Final Fill Sensor | 18. Filter Housing |
| 8. Mid-Level Sensor | 19. Check Valve (Fill Inlet) |
| 9. 25-Gal Sensor | 20. Fill Inlet |
| 10. Drain Valve | 21. Wiring (Pump, Motor, Valves, Sensors) |
| 11. Fill Valve | |

TABLE 1: ROUTINE MAINTENANCE SCHEDULE

PROCEDURE	PER BATCH	MONTHLY	AS NEEDED	REF. SECTION
RINSE CYCLE	X			6
VISUAL INSPECTION	X			8.1
CLEANING SURFACES	X			8.2
DISINFECTANT			X	8.3
FILTER			X*	8.4
CORROSION		X**		N/A
SPRAY BALL			X	SECT 6

* It is recommended to change the Filter after mixing 6 batches or when the GranuFlo I Dissolution Unit Requires Disinfection. If a tank becomes contaminated, the tank will need to be disinfected before a new filter is installed.

** It is recommended that the final fill sensor, propellers, shaft, connectors at every valve, and the unit's tank be checked for corrosion and salt deposits. Any excessively corroded part should be cleaned or replaced as needed.

(PAGE INTENTIONALLY LEFT BLANK)

Form 1: Granuflo® Dry – 132 Gallon Batch Production Record

Unit Name & Location # Operator Date Time

Dry Acid Dissolution Unit Serial # Batch #

1 Do ALL of the following (check when completed): Empty Tank Rinse Tank Verify Expirations

2 ADD Dry Acid Products and RECORD case information below:

Dry Acid Catalog #	BOX Lot #	<input checked="" type="checkbox"/> if 3 rd bag used
CASE 1:		<input type="checkbox"/>
CASE 2:		<input type="checkbox"/>
CASE 3:		<input type="checkbox"/>
CASE 4:		<input type="checkbox"/>
CASE 5:		<input type="checkbox"/>
CASE 6:		<input type="checkbox"/>
CASE 7:		<input type="checkbox"/>
CASE 8:		<input type="checkbox"/>

** After Final Fill Level has been reached, **CLOSE** water supply valve to the Unit then **CHECK HERE:**

3 FLUSH the transfer hose with 3.5 Gallons. **4** FILL a graduated cylinder from hose.

5 MEASURE temperature of liquid in cylinder to one decimal place. Enter value here: °C

6 MEASURE the Specific Gravity value*. Enter value here:

7 CIRCLE BOTH temperature range for the dry acid used AND the Low / High Specific gravity values for the catalog number below:

8 CHECK one of the following statements regarding the measured Specific gravity:

FAILED HIGH. Value was Above circled range.

PASSED. Value was within Circled table range.

FAILED LOW. Value was Below circled table range.

Catalog Number		16.5°C to 21.4°C (61.7°F to 70.6°F)		21.5°C to 26.4°C (70.7°F to 79.6°F)		26.5°C to 31.4°C (79.7°F to 88.5°F)	
		Low	High	Low	High	Low	High
1K	0FD1251-3B	1.191	1.203	1.188	1.200	1.186	1.198
	0FD2201-3B	1.191	1.203	1.189	1.201	1.187	1.199
	0FD2231-3B	1.192	1.204	1.190	1.202	1.187	1.199
	0FD2251-3B	1.192	1.204	1.190	1.202	1.188	1.200
	0FD2301-3B	1.193	1.205	1.191	1.203	1.189	1.201
3K	0FD3201-3B	1.193	1.205	1.191	1.203	1.188	1.200
	0FD3231-3B	1.194	1.206	1.191	1.203	1.189	1.201
	0FD3251-3B	1.194	1.206	1.192	1.204	1.189	1.201
	0FD3301-3B	1.195	1.207	1.193	1.205	1.190	1.202

Operator:
Signature

Reviewer:
Signature

Minimum Thermometer Specifications: Temperature Range 25°C +/- 10°C (59° to 95° F) and accuracy +/- 1°C (3.6 °F)
*Only use a hydrometer calibrated at 60°F following ASTM Standard E126.

(PAGE INTENTIONALLY LEFT BLANK)

If Spray Ball Ring is clogged call **TECHNICAL SUPPORT (1-800-227-2572)**.

Below Instructions are for Technical Service Use Only:

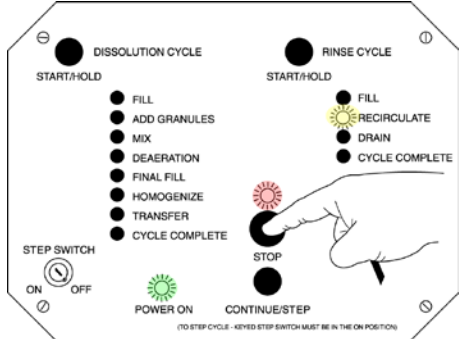
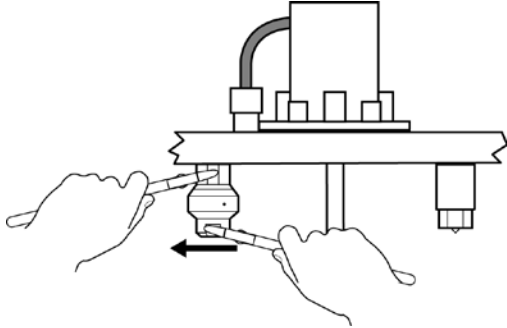
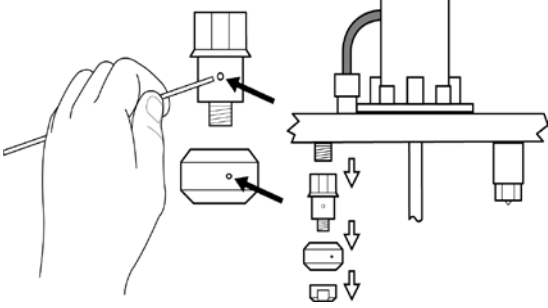
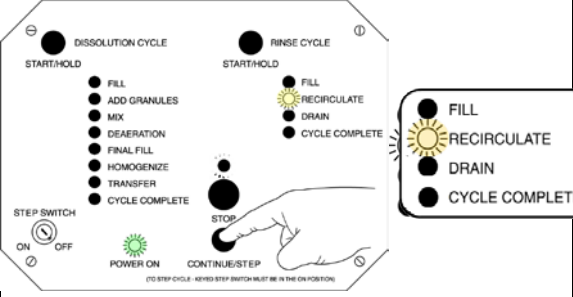
 <p>A. If the Spray Ball is stationary, push the STOP button.</p>	 <p>B. Remove the nut below the Spray Ball to access the sprayer.</p>
 <p>C. Clear the spray holes in both the Spray Ball and Sprayer of debris and reassemble.</p>	 <p>D. Press the CONTINUE/STEP button on the RINSE cycle side. PAUSE LIGHT will turn off and Recirculate Light will not flash. Check for proper Spray Ball Rotation before continuing to pg. 12.</p>

(PAGE INTENTIONALLY LEFT BLANK)

SECTION 11: LIMITED WARRANTY

Fresenius USA, Inc., (the Company) warrants to the purchaser that the equipment delivered is free from defects in material and workmanship for the period specified below, provided that the equipment is used and maintained in accordance with the Company's Operating Instructions.

- A. Mainframe chassis and electronic components, lamps, etc. shall be warranted for ninety (90) days from the date of initial installation or one hundred and eighty (180) days from the date of shipment, whichever comes first.
- B. Consumables shall not be warranted.

The Company will repair or replace, at the company's option, using new or reconditioned parts and/or assemblies, any parts subject to this warranty which are proven defective in materials or workmanship. Such repair and replacement will be made without cost to the purchaser. The Company reserves the right to determine the location at which the repair or replacement shall be accomplished.

This Warranty does not apply to any equipment which is misused, abused, neglected, tampered with, damaged by accident, flood, fire, corrosion, or other hazard, subjected to abnormal or unusual electrical or fluid stress, improperly installed or operated, not maintained in accordance with the routine maintenance schedule set forth in this Operator's Manual.

The foregoing Warranty shall be in lieu of any other warranties, expressed, implied or statutory, respecting the equipment or any parts or components thereof. The Company makes no implied warranty of merchantability or fitness for a particular purpose. The purchaser's sole and exclusive remedy in contract, tort or under any other theory against the Company respecting the equipment and its use shall be the replacement or repair of the equipment and its parts as described above, and no other remedy (including, without limitation, consequential damages) shall be available to the purchaser. The Company shall have no further obligation of liability with respect to the equipment or its sale, operation and use, and the Company neither assumes, nor authorized the assumption of, any obligation or liability in connection with such equipment.

TERMS: Net 30 Days, FOB Shipping Points plus sales and similar taxes. The Company's prices do not include sales, use, excise or similar taxes. Consequently, in addition to the prices specified herein, the amount of any present or future sales, use, excise or similar tax applicable to the sale or use of the equipment hereunder shall be paid by the purchaser, or in lieu thereof, the purchaser shall provide the Company with a tax exemption certificate acceptable to the taxing authorities.

INSTALLATION: purchase prices will include installation and operation training for purchaser's personnel when a complete system is purchased. Installation for replacement parts will be charged to the purchaser on a time, material and expense basis unless covered under the limited warranty or a service contract.

SHIPPING: The Company will use its own judgment in determining the most effective method of shipping unless otherwise specified by the purchaser.

(PAGE INTENTIONALLY LEFT BLANK)

SECTION 12: CUSTOMER SUPPORT

Refer all servicing and information requests to:

Fresenius USA, Inc.
4040 Nelson Avenue
Concord, CA 94520
TEL: 1-800-227-2572

(PAGE INTENTIONALLY LEFT BLANK)

SECTION 13: DEFINITION OF TERMS

IDENTIFYING INDICATORS:

- **Rinse Cycle Status-** The RINSE cycle has four Operations- FILL, RECIRCULATE, DRAIN and CYCLE COMPLETE. The first three: FILL, RECIRCULATE, DRAIN is done twice before it reaches CYCLE COMPLETE. An indicator light will illuminate on the control panel to highlight which operation is currently in process during the cycle.
- **Dissolution Cycle Status-** The DISSOLUTION cycle has eight Operations- FILL, ADD GRANULES, MIX, DEAERATION, FINAL FILL, HOMOGENIZE, TRANSFER and CYCLE COMPLETE. An indicator light will illuminate on the control panel to highlight which operation is currently in process during the cycle.
- **Power On-** An indicator light will illuminate to alert the operator that the Dissolution Unit is powered on.

CONTROL PANEL BUTTONS:

- **Step Switch-** If at any time the operator needs to step from the current operation to another, the STEP mode may be used. When the STEP SWITCH is in the ON position, all operations will be suspended. STEP MODE function is NOT to be used to speed up the dissolution or rinse operations.
- **Continue/Step -** Press the CONTINUE/STEP button to step to the desired operation.
- **Stop-** If at any time the operator needs to stop a timed process during a cycle, the STOP button may be pressed.
- **Dissolution Cycle START/HOLD-** Press the dissolution START/HOLD button to initiate the Dissolution Cycle.
- **Rinse Cycle START/HOLD-** Press the rinse START/HOLD button to initiate the Rinse Cycle.

OTHER COMMON TERMS:

- **Acetic Acid-** It is a colorless liquid that when undiluted is also called *glacial acetic acid*, which is classified as a weak acid. As the main component of vinegar, it has a distinctive sour taste and pungent smell.
- **ANSI/AAMI-** Association for the Advancement of Medical Instrumentation and American National Standards Institute.
ANSI/AAMI RD61: 2006 Concentrates for hemodialysis
ANSI/AAMI RD62: 2006 Water treatment equipment for hemodialysis applications
- **CFU/mL-** In microbiology, **colony-forming unit (CFU or cfu)** is a measure of viable bacterial or fungal numbers. Unlike direct microscopic counts where all cells, dead and living, are counted, CFU measures viable cells. For convenience the results are given as CFU/mL (colony-forming units per milliliter) for liquids and CFU/g (colony-forming units per gram) for solids.
- **GFI (Ground Fault Interrupter) -** is an electrical wiring device that disconnects a circuit whenever it detects that the electric current is not balanced between the energized conductor and the return neutral conductor.
- **GPM-**Gallons Per Minute
- **Hydrometer-** an instrument used to measure the specific gravity (or relative density) of liquids; that is, the ratio of the density of the liquid to the density of water.
- **IEC -** International Electrotechnical Commission is an organization that sets international electrical and electronics standards founded in 1906. It is made up of national committees from over 60 countries.
IEC 60601-1 General safety requirements for Medical Devices
- **ISO-** International Organization for Standardization is an international standard-setting body composed of representatives from various national standards organizations.
ISO 13958:2009 Concentrates for hemodialysis and related therapies
ISO 13959:2009 Water for hemodialysis and related therapies

- **LED**-Light Emitting Diode
- **Meniscus** - A meniscus is phase boundary that has been curved because of surface tension. *Also Known As:* menisci, meniscuses.

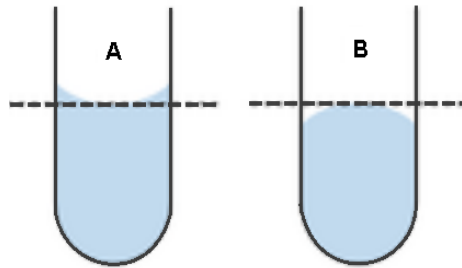

Measure the meniscus at eye level from the center of the meniscus. In the case of water and most liquids, the meniscus is concave (A). Mercury produces a convex (B) meniscus.

- **NEC- National Electrical Code** is a United States standard for the safe installation of electrical wiring and equipment.
- **OEM** - Original Equipment Manufacturer
Parts used in the manufacturing of the GranuFlo I Dissolution Unit have been specified, qualified, and tested as per the guidelines set by FMCNA in accordance with the requirements of *Systems for Mixing Concentrate at a Dialysis Facility* listed in Section 5.3 of the American National Standards Institute (ANSI) / Advancing Safety in Medical Technology (AAMI) RD61:2006 and Section 5.4 of the International Organization for Standardization (ISO) 13958:2009 Regulations.
- **Residual Solution Bucket** – This bucket can be purchased at any hardware store and should be made of plastic since a metal bucket corrodes quickly. Any 5 or more gallon bucket can be used. The use of a bottleneck type container should be avoided.



- **Specific Gravity** - is the ratio of the density (mass of a unit volume) of a substance to the density (mass of the same unit volume) of a reference substance. *Apparent* specific gravity is the ratio of the weight of a volume of the substance to the weight of an equal volume of the reference substance.

SECTION 14: CONCENTRATE SOLUTION DISPOSAL OR DISPOSITION

14.1 RESIDUAL SOLUTION DISPOSAL OR DISPOSITION

There are three occasions that require the need to discard or disposition residual solution. Those occasions are described as follows:

- **Filter Housing Residual:** Whenever you have to change out a Filter, then the solution in the Filter Housing shall be poured into the *Residual Solution Bucket* and then discarded.
- **Hydrometer Cylinder Residual:** Once you are complete with the Specific Gravity Test, the solution in the Hydrometer Cylinder shall be poured into the *Residual Solution Bucket and then discarded.*
- **Initial 3.5 Gallon Transferred Solution:** This is the 3.5 gallons of solution transferred into the *Residual Solution Bucket* in the beginning part of the Specific Gravity Test, section 7.1, page 17. This solution shall be dispositioned according to clinic policies and procedures.

14.2 TANK SOLUTION DISPOSAL

There are five occasions in which you will need to discard the solution in the GranuFlo I Dissolution Unit. Those occasions are described as follows:

- **Expired Solution:** If solution remains in the GranuFlo I Dissolution Unit Tank for more than 14 days.
- **Foreign Object:** Any foreign object falling into the GranuFlo I Dissolution Unit Tank after the dry acid product has been added.
- **Incorrect Catalog Used:** Any batch preparation with incorrect dry acid product catalog (s) numbers
- **Specific Gravity Out of Range:** Any batch prepared that has been found out of range.
- **GranuFlo I Dissolution Unit Needing Service:** Any GranuFlo I Dissolution Unit that contains solution that becomes inoperable.

CONCENTRATE SOLUTION DISPOSAL PROCEDURE:

MIXED DRY ACID CONCENTRATE SOLUTION HAS A PH BELOW 6. THEREFORE, IF YOU MUST DISPOSE OF ACID CONCENTRATE SOLUTION BECAUSE OF ONE OF THE ABOVE SITUATIONS, YOU SHOULD FOLLOW ANY APPLICABLE DISPOSAL REQUIREMENTS OF YOUR LOCAL, STATE, AND/OR FEDERAL AUTHORITIES. SEE CLINIC MANAGER FOR MORE INFORMATION.



WARNING! SOME CHEMICALS USED TO NEUTRALIZE ACID CONCENTRATE SOLUTIONS MAY CAUSE SPLATTERING AND/OR GENERATE DANGEROUS LEVELS OF GASES WHEN COMBINED. FOR EXAMPLE, POTENTIALLY DANGEROUS LEVELS OF CARBON DIOXIDE MAY BE RELEASED WHEN SODIUM BICARBONATE IS USED AS THE NEUTRALIZING AGENT. PLEASE CAREFULLY CONSIDER THESE ISSUES, INCLUDING PROPER VENTILATION, IF NEUTRALIZATION IS REQUIRED.

Immediately after a tank disposal, step unit to CYCLE COMPLETE, press STEP MODE button to turn OFF, then ensure that the water inlet valve is open and perform two (2) RINSE CYCLES by pressing the RINSE CYCLE start button and by pressing it again when the first RINSE CYCLE is completed. After completing two (2) full RINSE CYCLES visually inspect if there are any powder deposits remaining in the tank. These can be removed by running additional RINSE CYCLES in the unit

Immediately after rinsing the tank clean, make a batch of Dry Acid Product. Leaving the GranuFlo I Dissolution Unit with only treated water or wetted with only treated water leaves the Unit susceptible to bacterial growth.



CAUTION! DO NOT ALLOW THE UNIT TO REMAIN FULL OF WATER WITHOUT THE ADDITION OF FRESENIUS MEDICAL CARE GRANUFLO DRY ACID PRODUCT. BACTERIAL GROWTH MAY OCCUR.

(PAGE INTENTIONALLY LEFT BLANK)

GranuFlo® Acid Concentrate

GranuFlo Acid Mixing Procedure Card

This card is intended to be a supplement to the Fresenius Renal Technologies Dry Acid Dissolution Unit Operator's Manual and the GranuFlo Operator's Manual and product labels. Refer to the Fresenius Renal Technologies Dry Acid Dissolution Unit Operator's Manual and the GranuFlo acid concentrate product labels for a complete description of mixing instructions, hazards, contraindications and precautions.

Preparation for Dissolution Cycle

- i** Note: GranuFlo Concentrate Dissolution Units are designed for use with GranuFlo acid product only. Dry Acid Dissolution Units are designed for use with Citrasate® Dry acid or GranuFlo acid products only. Note: Do not use GranuFlo acid concentrate cases if package is opened or damaged.

- 1 Determine how much product is required for mixing (See Table 1 below).

Dry Acid Dissolution Unit	No. of Cases Needed
99 gallon mixer	6
132 gallon mixer	8

Table 1: GranuFlo Acid Concentrate Case Requirements

- 2 Check case labels to ensure all cases are of the same catalog number.
- 3 Complete the Dry Acid Batch Production Record form.
- 4 Use water that meets or exceeds ANSI/AAMI RD62 or ISO 13959 hemodialysis water quality standards. Water temperature should be 20°C-30°C (68°F-86°F) for proper dissolution.

Instructions for Dissolution

- i** Note: The contents in the GranuFlo acid cases may clump or harden. This does not affect the chemical composition of the product. While the images below depict the GranuFlo Dissolution Unit, the following instructions are for GranuFlo Concentrate Dissolution Units and Dry Acid Dissolution Units.

Rinse cycle must be completed prior to inflating the batch of concentrate.

- 1 Ensure access port lid is in place, main transfer ball valve is closed and Input Water Source is On.
- 2 Press the RINSE START button.



- 3 Begin the Fill Cycle on the Dry Acid Dissolution Unit by pressing the DISSOLUTION START button.
- 4 Wait for the ADD GRANULES light prior to adding dry acid product.
- 5 Using eye protection and gloves is recommended. If contact with eyes occurs, flush immediately for 15 minutes. If contact with skin occurs, rinse with plenty of soap and water.



(PAGE INTENTIONALLY LEFT BLANK)

GranuFlo Acid Concentrate

GranuFlo Acid Mixing Procedure Card

Instructions for Dissolution (Continued)

6 Remove small access lid on GranuFlo Dissolution Unit or Dry Acid (Dissolution Unit).

7 Open a case of GranuFlo concentrate and cut off the tops of all bags just below the bag seal, leaving as much extra bag length as possible.



8 Gather extra bag material at the top with your thumb facing down. This will allow the proper hand position when the bag is inverted.



9 Grab the flap on the bottom of the bag and invert the bag. Insert the gathered end into the small opening in Dissolution Unit.



10 Release the gathered end of the bag and allow the contents to empty into the tank. Once all of the powder has transferred to the dissolution unit remove and discard the empty bag.



11 Repeat steps 7-10 until the correct number of bags have been emptied into the Dissolution Unit.



Note: Each case contains three bags. The contents of the bags in each case are different. All bags must be used.

(PAGE INTENTIONALLY LEFT BLANK)

12 Dry off the Final Fill Sensors.

Label the Dissolution Unit with contents and dates prepared.



13 Replace the small access lid and press the **DISSOLUTION START** button. The Dissolution Unit will proceed to the Mix Operation. Follow the instructions to complete the mixing process as directed by the Operator's Manual for your specific Dissolution Unit.



14 Once the Transfer Indicator Light flashes, the concentrate can be tested for the specific gravity.



15 After the specific gravity value is within recommended limits, follow the instructions in your operators manual to transfer the solution to appropriate storage containers.



Note: Reconstituted acid concentrate should not be stored in the Dissolution Unit tank for longer than two weeks from the date of dissolution.

(PAGE INTENTIONALLY LEFT BLANK)

Indications for Use: GranuFlo Dry Acid Concentrate is indicated for use in patients undergoing extracorporeal bicarbonate hemodialysis for acute and chronic renal failure. GranuFlo Dry Acid Concentrate is intended to be used as one component in the preparation of dialysate in a three-stream proportioning hemodialysis machine according to a physician's prescription.

The Fresenius Medical Care Dry Acid Dissolution Unit mixes Fresenius Medical Care distributed dry acid concentrate products with hemodialysis quality water. The resulting liquid acid concentrates are intended for use in three-stream hemodialysis machines calibrated for acid and bicarbonate concentrates.

Caution: Federal (US) law restricts this device to sale by or on the order of a physician.

Note: Read the Instructions for Use for safe and proper use of this device. For a complete description of hazards, contraindications, side effects and precautions, see full package labeling at www.fmcna.com.

Customer Service: 800-323-5188 • Technical Support: 800-227-2572



Fresenius Renal Technologies, a division of Fresenius Medical Care North America
920 Winter Street • Waltham, MA • 02451
1-800-662-1237 • www.fmcna-concentrates.com

© 2014, 2015, 2018 Fresenius Medical Care. All Rights Reserved. Fresenius Medical Care, the triangle logo, Fresenius Renal Technologies, and GranuFlo are trademarks of Fresenius Medical Care Holding, Inc. or its affiliated companies. Citrasate is a registered trademark of Advanced Renal Technologies in the United States and is used under license from Advanced Renal Technologies. All other trademarks are the property of their respective owners. PIN 102306-01 Rev C 12/2018

(PAGE INTENTIONALLY LEFT BLANK)

APPENDIX B: FIRST BATCH VERIFICATION INSTRUCTIONS

1. Once the Final Fill Sensor is replaced or unit relocated and the empty sample bottles are available. Plug in the power cord. Turn treated water on. Turn the power switch ON. Verify the power light activates.
2. As per the Operator's Manual section 6.0, secure the tank lid and initiate the RINSE CYCLE.
3. As per the Operator's Manual section 7.0, run a DISSOLUTION CYCLE by pressing the DISSOLUTION Start Button. When the ADD GRANULES light flashes check to make sure water has reached the Mid-Level Sensor, and then add the eight (8) boxes of GranuFlo® product.



NOTE: MAKE SURE TO FILL IN THE GRANUFLO BATCH PRODUCTION RECORD, PAGE 31, OF THIS MANUAL WITH THE PRODUCT INFORMATION.



WARNING: DO NOT USE ANY BOX OF GRANUFLO® DRY CONCENTRATE THAT HAS BEEN OPENED OR TAMPERED WITH. IT IS IMPORTANT THAT THE ENTIRE CONTENTS OF EACH BOX ARE EMPTIED INTO THE DISSOLUTION TANK.



WARNING! THE USE OF EYE PROTECTION, AND GLOVES IS RECOMMENDED WHEN HANDLING DRY ACID PRODUCT. IF CONTACT WITH EYES, RINSE IMMEDIATELY FOR 15 MINUTES. IF CONTACT WITH SKIN, FLUSH WITH PLENTY OF SOAP AND WATER. SEE MATERIAL SAFETY DATA SHEETS (MSDS) FOR THE DRY ACID PRODUCT BEING USED FOR FURTHER PERSONAL PROTECTIVE EQUIPMENT (PPE) OR EMERGENCY REQUIREMENTS/INSTRUCTIONS.

4. As per the Operator's Manual section 7.1, perform the *Specific Gravity* Test and record the results in the GranuFlo batch production record, page 31.
5. Collect a sample of the final product(s) using the (2) sample bottles (P/N G83-535-02). The product sample(s) will be analyzed in accordance to manufacturer's product specifications. If only one product code is being used, collect two (2) samples of that product to be analyzed.
6. Place the sample bottles and the following completed forms into a shipping box:
 - Copy of Granuflo Batch Production Record Form (Operator's Manual page 31)
 - Batch Analysis Form (Operator's Manual page 53)
7. Cutout and affix the pre-printed mailing label from the Batch Analysis Form to the box. It is the responsibility of the RES to ship the samples to the "Ship To" address on the Batch Analysis Form. Contact Fresenius Medical Care Laboratory: at (972)-929-7291 for results.
8. NOTICE: The composition of the first batch of GranuFlo® must be tested by a qualified testing laboratory to ensure that the resulting product meets the GranuFlo® Dry Acid product specifications. If final solution did not meet final batch criteria for use, the batch of concentrate must be discarded (SEE SECTION 13: CONCENTRATE SOLUTION DISPOSAL OR DISPOSITION, PAGE 41).

PAGE INTENTIONALLY LEFT BLANK)



**FRESENIUS
MEDICAL CARE**

BATCH ANALYSIS FORM

Customer Information Form



NOTE: TO PREVENT BATCH ANALYSIS DELAYS, THIS FORM MUST BE COMPLETE AND ACCURATE.

Clinic Name: _____

Contact Name: _____ Contact Phone Number: _____

Clinic Fax Number: _____ **OR** Email: _____ @ _____

Dissolution Tank Serial Number: _____

Product Catalog Number: _____

Important: Incorrect catalog number **will** affect the test results.

Lot Number: _____

Date Sample Taken: _____ Sample By: _____

Ship To:

Fresenius Medical Care
Irving Manufacturing
5201 Regent Blvd., Suite 100
Irving, TX 75063
Attention: Laboratory
Ship: **Overnight**

(PAGE INTENTIONALLY LEFT BLANK)

(PAGE INTENTIONALLY LEFT BLANK)