

**THIS DOCUMENT IS FOR TRAINING PURPOSES ONLY.  
PLEASE REFER TO THE OPERATOR'S MANUAL FOR COMPLETE INSTRUCTIONS.**

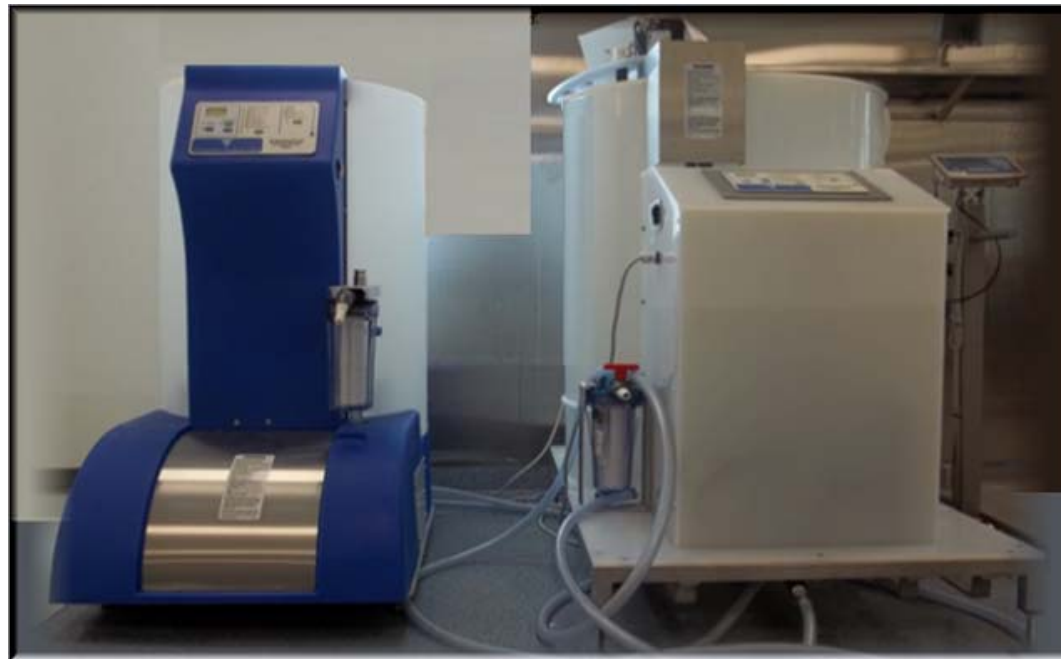

# GranuFlo® I Version 2 and GranuFlo® II w/ Citrasate® DRY Update Kit Mixing Training Course

P/N 460030 Rev. D



"Mixing Training Course" P/N 460030 Rev. D

# Introduction

## COURSE DESCRIPTION

This course is intended to provide dry acid mixing training to inexperienced and experienced operators of the 99 and 132 Gallon Fresenius Medical Care GranuFlo Dissolution Units.

## TEXT AND REQUIRED SUPPLIES / EQUIPMENT

- ❑ P/N 450385-03 GranuFlo I Version 2 Citrasate® DRY update kit– Operators Manual
- ❑ P/N 450368-03 GranuFlo II Citrasate® DRY update kit – Operators Manual
- ❑ GranuFlo I or GranuFlo II Ver. 2 (Installed by FMCNA Qualified Technician.)
- ❑ Citrasate Dry Acid Update Kit (160157 or 160158)
- ❑ Hydrometer and Hydrometer Cylinder
- ❑ Thermometer (min. req. 25°C ±5 °C (68 ° to 86 °F) and accuracy ±1 °C (3.6 °F)
- ❑ Bucket/Container (approx. 3.5 gal)
- ❑ pHoenix Meter (EMD pH-indicator strips, Cat. #9590 or equivalent)
- ❑ PPE Equipment (Eye Protection and Gloves)
- ❑ 1 micron filter

# Dissolution Units Overview

**GranuFlo II Dissolution Unit**

**GranuFlo I (Ver. 2) Dissolution Unit**

# CONTROL PANEL

- There are two (2) pre-programmed cycles :
  - RINSE CYCLE**
  - DISSOLUTION CYCLE**
- The **CONTROL PANEL** will display the GranuFlo Dissolution Unit **STATUS** at any given time.
- The left side of the panel displays the **DISSOLUTION CYCLE**.
- The right side of the control panel displays the **RINSE CYCLE**.

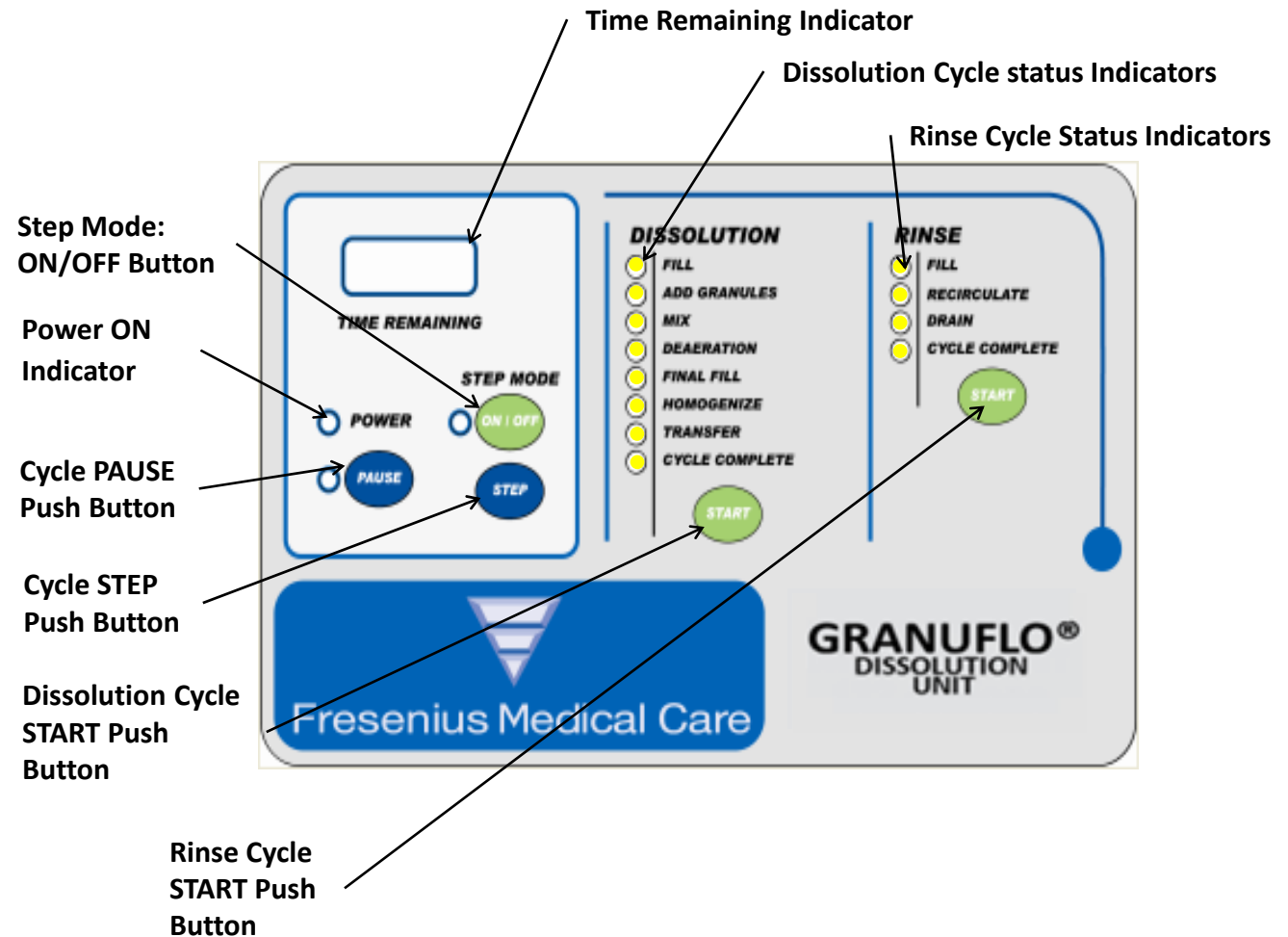

# EXTERNAL COMPONENTS

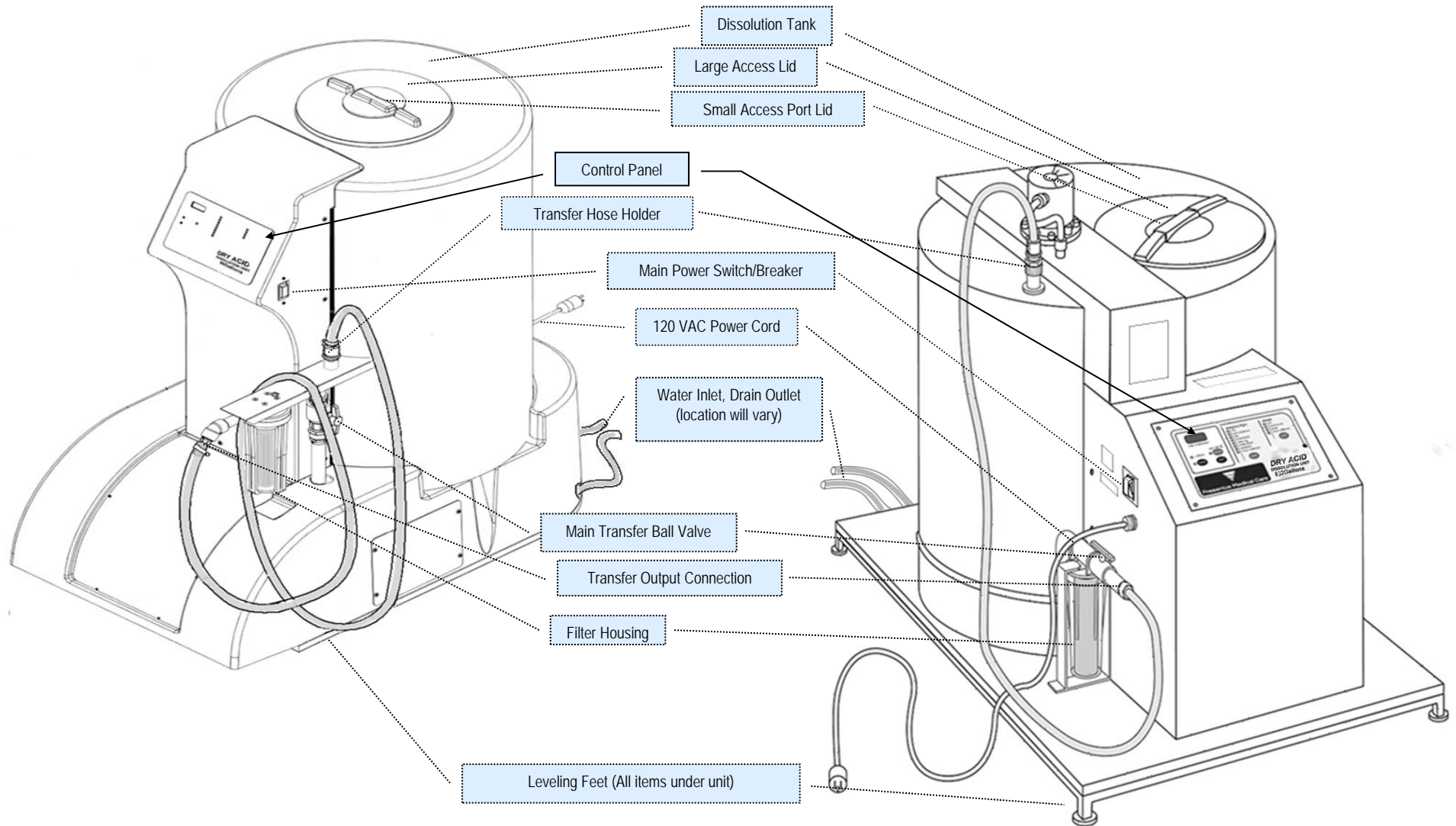

# INTERNAL COMPONENTS

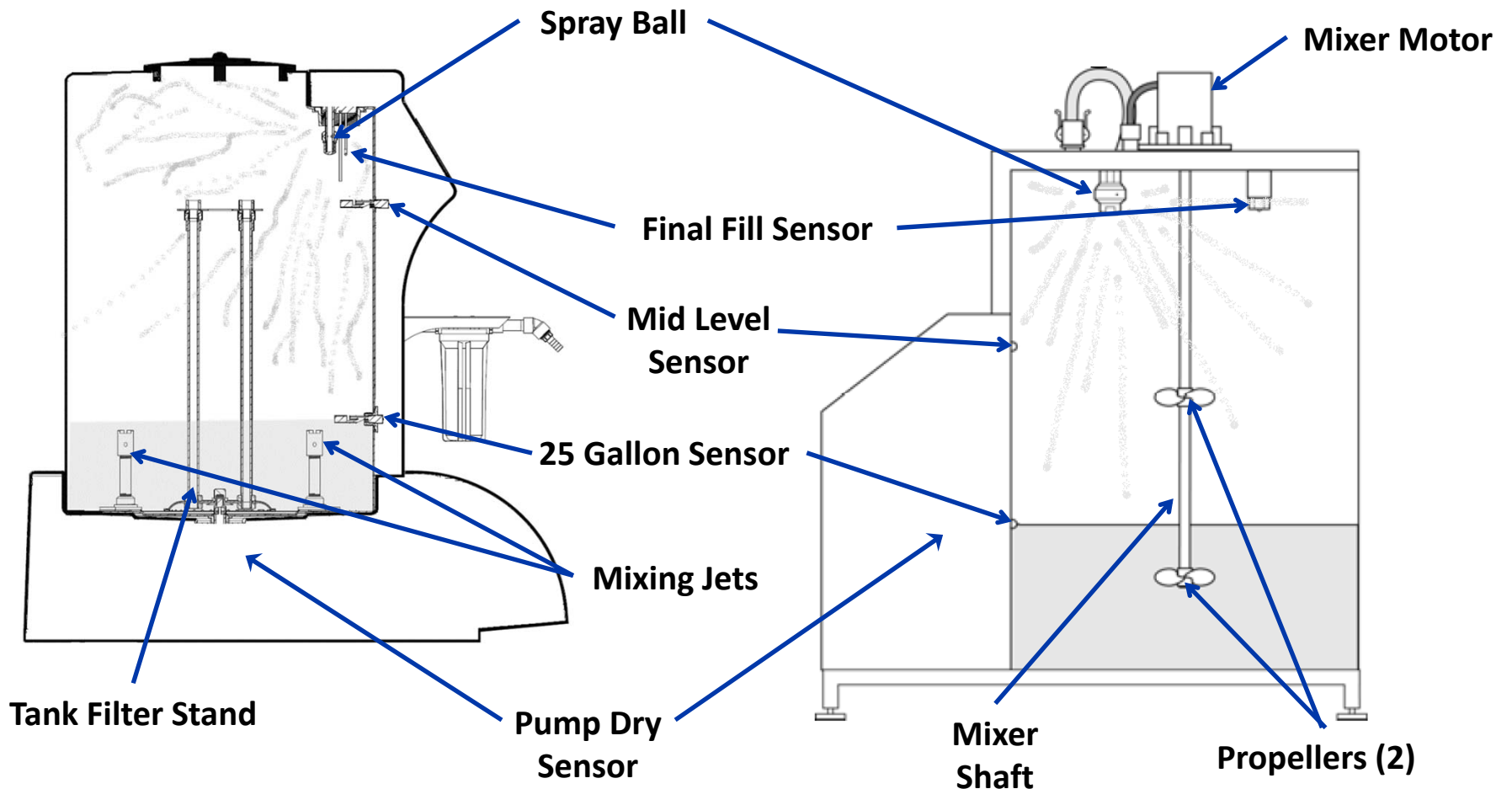

# BASIC HYDRAULICS

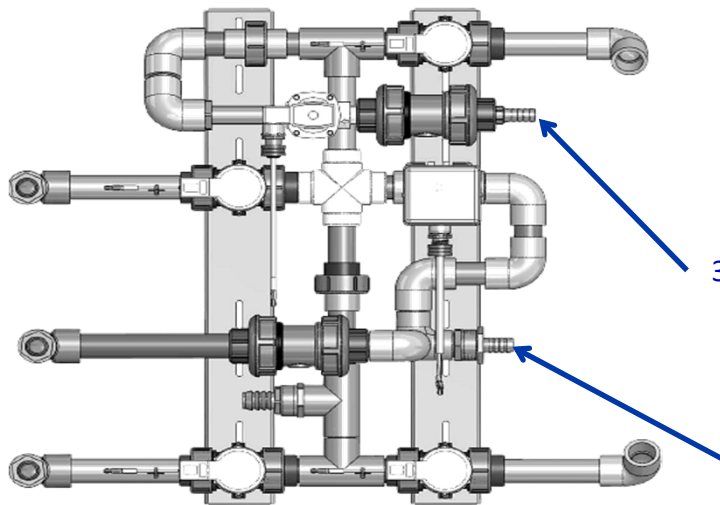

99 GranuFlo Unit: Top View of Piping/Valve Manifold

3/4" Barb: Water Input

3/4" Barb: Drain Output

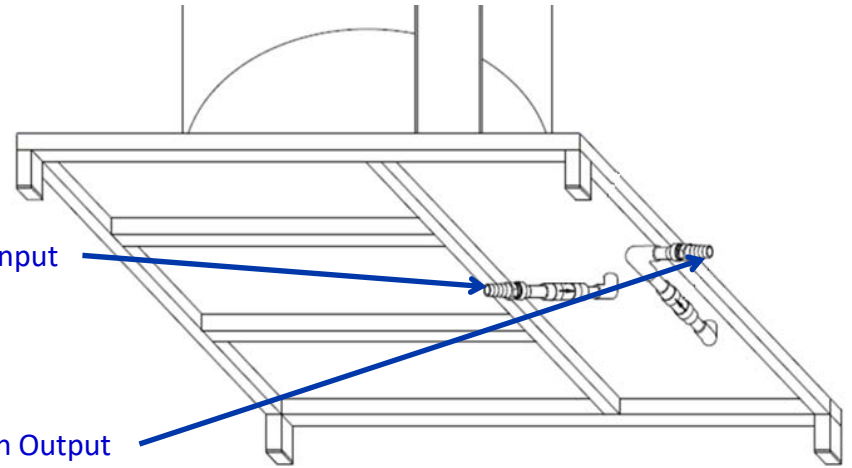

132 GranuFlo Unit: Bottom View; Input/Drain Location

# Mix Process Overview

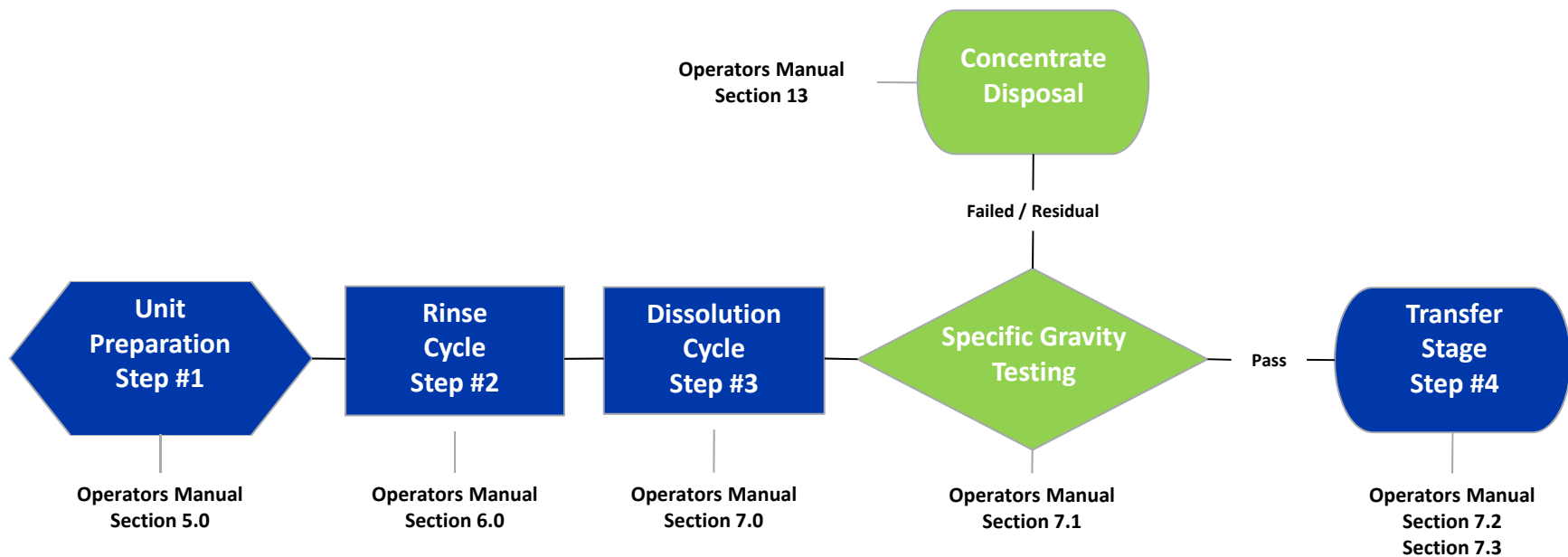



# UNIT PREPARATION

## Step #1

**Operators Manual:**  
Section 5.0

# Unit Preparation (Mix Process Step #1)

## Operators Manual Section 5.0

- ❑ **Power cord** is connected to 120 volts, 60 Hz, single phase 15 amp; GFI protected circuit.
- ❑ Be certain the GranuFlo Dissolution Unit **Drain Hose** is over a floor drain and **Transfer Hose** is connected to Transfer Hose Holder.
- ❑ **Purified water** source is turned ON.
- ❑ **Power** is in the ON position.
- ❑ Maximum **Input Water Pressure** is 60 PSI.

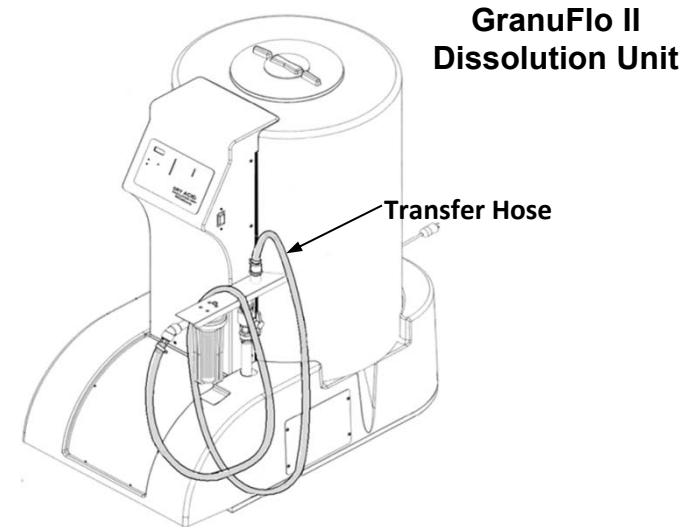
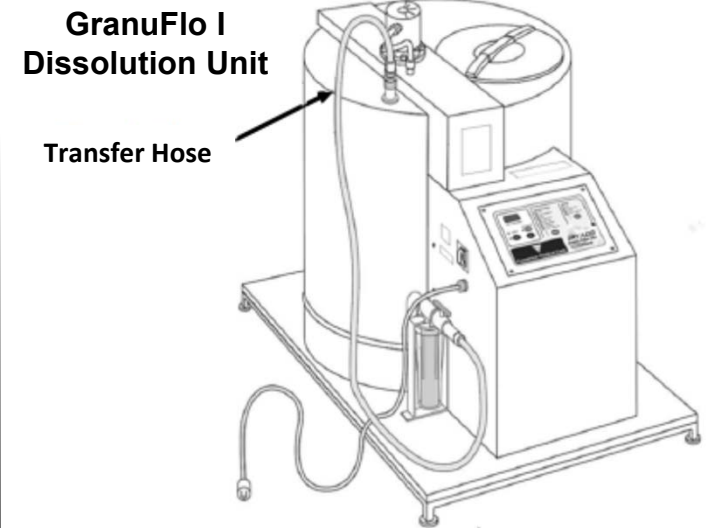

# RINSE CYCLE

## Step #2

**Operators Manual: Section 6.0**

# Rinse Cycle (Mix Process – Step #2)

## Operators Manual Section 6.0

1. Before initiating the **RINSE CYCLE**, the operator must ensure that:

- Access Port Lid is **IN PLACE**.
- Transfer Valve is in the **CLOSED** position.
- Input water source is in the **ON** position.

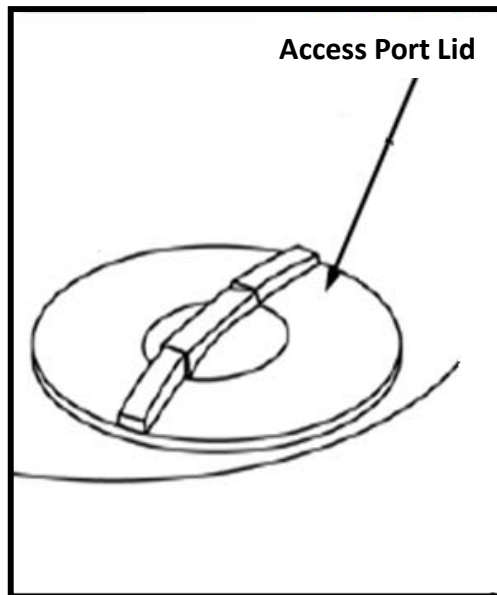

Place transfer valve in the closed position by turning the handle clockwise until it stops.

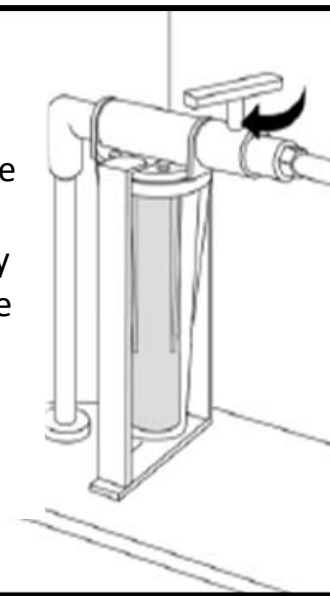

GranuFlo I  
Dissolution Unit

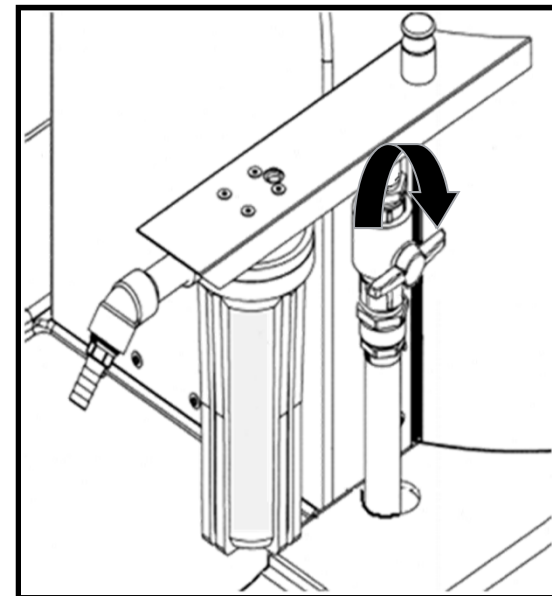

GranuFlo II  
Dissolution Unit

# Rinse Cycle (Mix Process – Step #2)

## Operators Manual Section 6.0

2. Press the Rinse side **START** button.

**FILL** indicator (on rinse cycle side) will illuminate and tank will automatically start to fill up with water until it reaches the 25-Gallon Sensor.

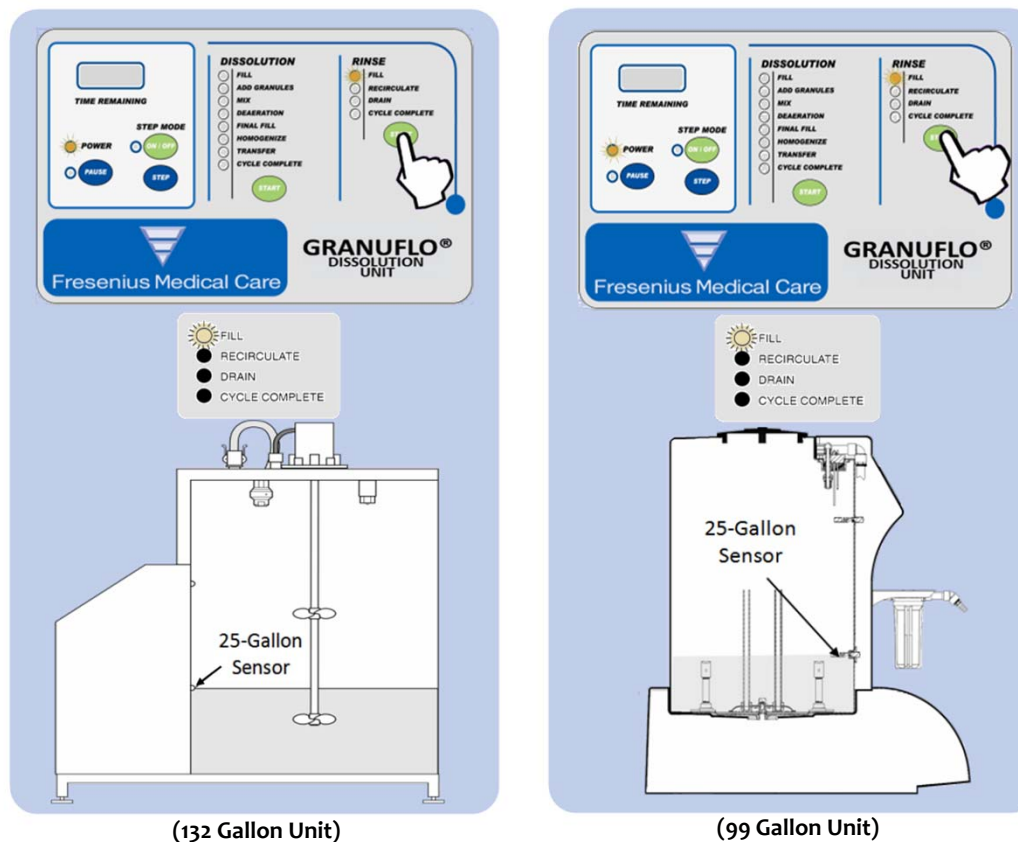

# Rinse Cycle (Mix Process – Step #2)

## Operators Manual Section 6.0

3. Once the 25-Gallon Sensor is reached, the process automatically steps to **RECIRCULATE** operation.
  - The recirculate operation will run for **twelve (12) minutes** on the **GranuFlo II Dissolution Unit**.
  - The pump and the mixer motor will run for a **ten (10) minute** period for the **GranuFlo I Dissolution Unit**.
  - During this time period, follow the procedure outlined to inspect the spray ball (**See Next Slide**).

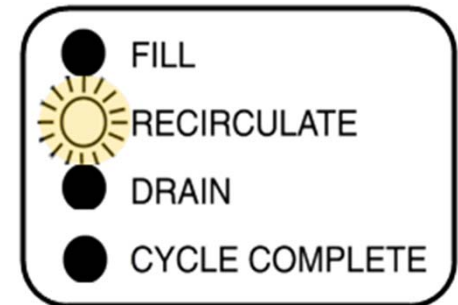

# Rinse Cycle (Mix Process – Step #2)

## Operators Manual Section 6.0

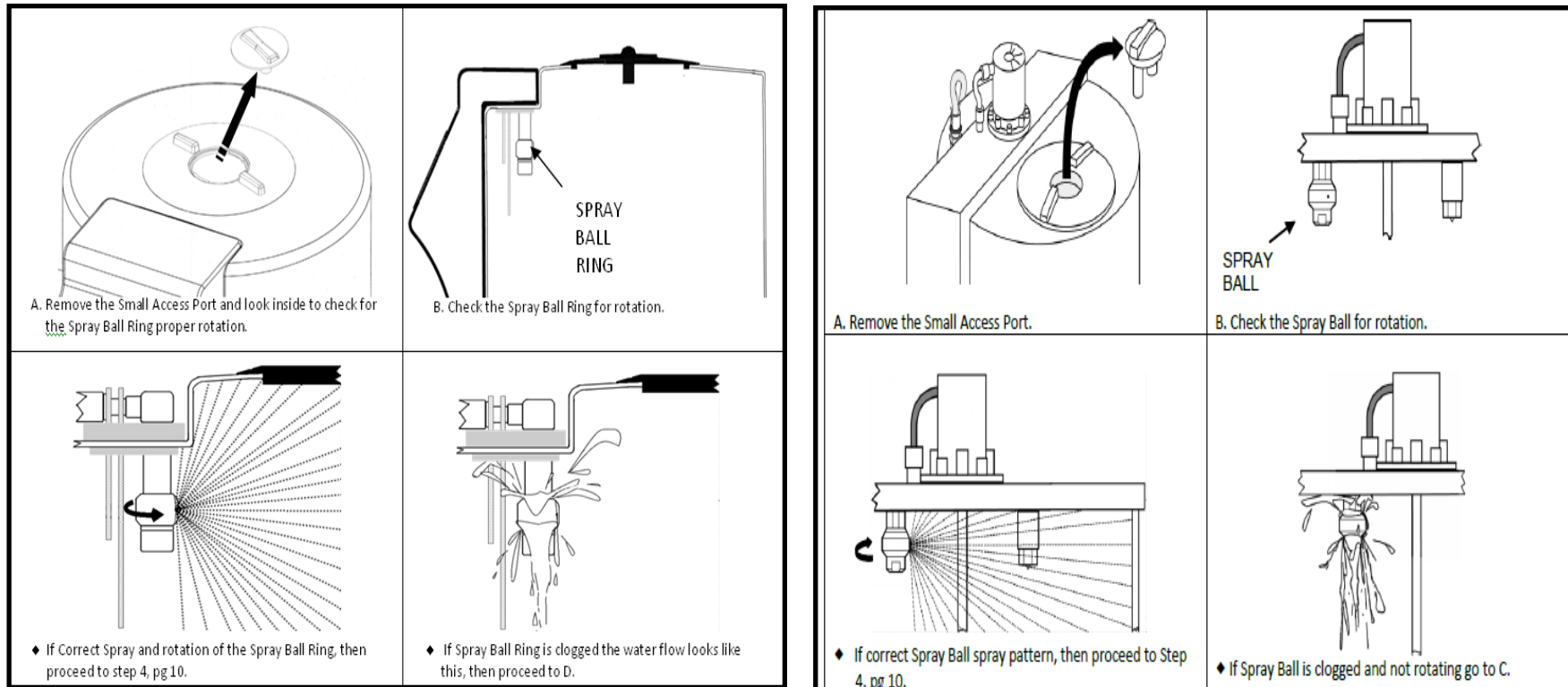

GranuFlo II  
Dissolution Unit

GranuFlo I  
Dissolution Unit

Use Eye  
Protection

# Rinse Cycle (Mix Process – Step #2)

## Operators Manual Section 6.0

**FOR TECHNICAL SERVICE ONLY!**

<p>C. If the Spray Ball is stationary, push the PAUSE button. RECIRCULATE LED will flash. Turn Main Power Switch OFF.</p>	<p>D. Remove the nut below the Spray Ball to access the Sprayer.</p>	<p>C. If the Spray Ball is stationary, push the PAUSE button. RECIRCULATE light will flash.</p>	<p>D. Remove the nut below the Spray Ball to access the sprayer.</p>
<p>E. Clear the spray holes in both the Spray Ball Ring and Sprayer of debris and reassemble.</p>	<p>F. Turn main Power Switch ON. Press RINSE CYCLE START button. PAUSE LED will turn off and RECIRCULATE LED will not flash. Check for proper Spray Ring rotation before continuing to pg. 10.</p>	<p>E. Clear the spray holes in both the Spray Ball and sprayer of debris and reassemble.</p>	<p>F. Press the START button on the RINSE cycle side. PAUSE light will turn off and RECIRCULATE light will not flash. Check for proper Spray Ball Rotation before continuing to pg. 10.</p>

GranuFlo II  
Dissolution Unit

GranuFlo I  
Dissolution Unit



# Rinse Cycle (Mix Process – Step #2)

## Operators Manual Section 6.0

- When the **RECIRCULATE** operation is complete the GranuFlo Dissolution Unit will switch to **DRAIN** operation and empty rinse water from the GranuFlo Dissolution Unit to the floor drain.

**Note:** *This is a 10 minute timed cycle for the 132 gal. GranuFlo Dissolution Unit.*

- At the completion of the DRAIN operation, the GranuFlo Unit will refill to the 25-Gallon Sensor. The **Fill** Indicator Light will turn on and the RINSE operation will start.

- When the second RINSE CYCLE is finished, the GranuFlo Dissolution Unit will go to the **CYCLE COMPLETE** operation. The Rinse Cycle Complete Indicator Light will turn ON and the Drain Valve will remain open, allowing any residual rinse water to go down the drain.

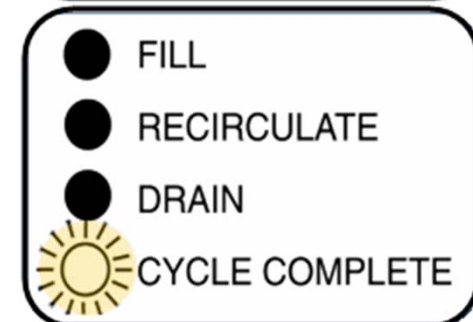
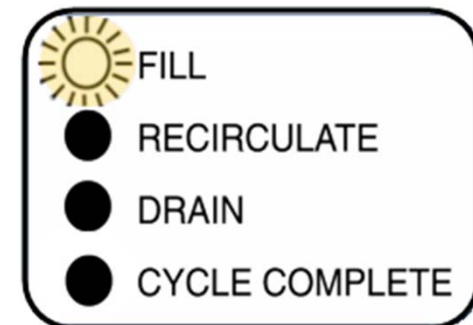
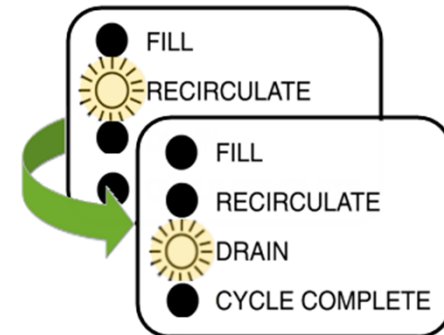

# RINSE CYCLE EXAMPLE

# Rinse Cycle (Mix Process – Step #2)

## Example

### FILL Operation

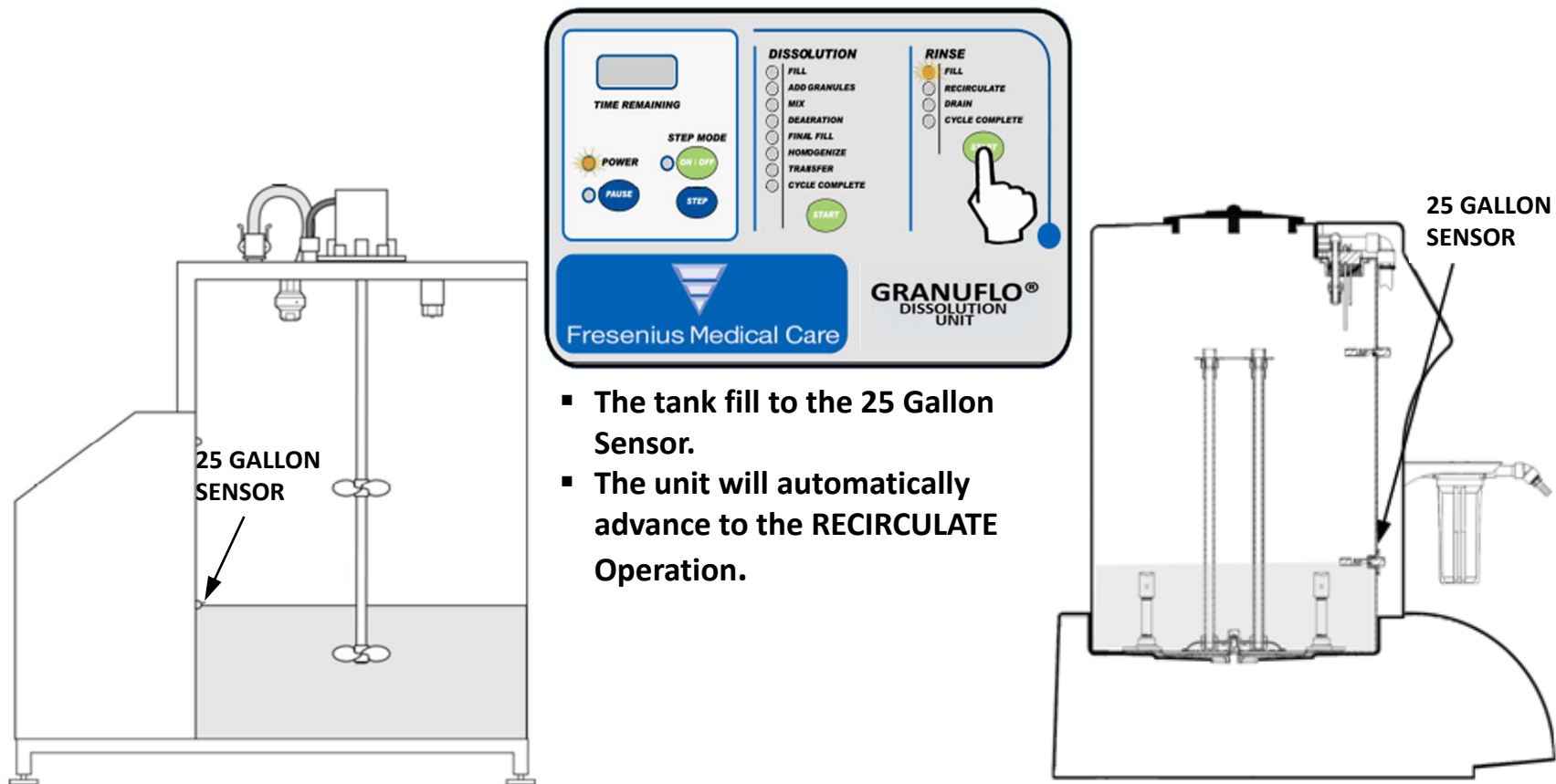

# Rinse Cycle (Mix Process – Step #2)

## Example

### RECIRCULATE Operation

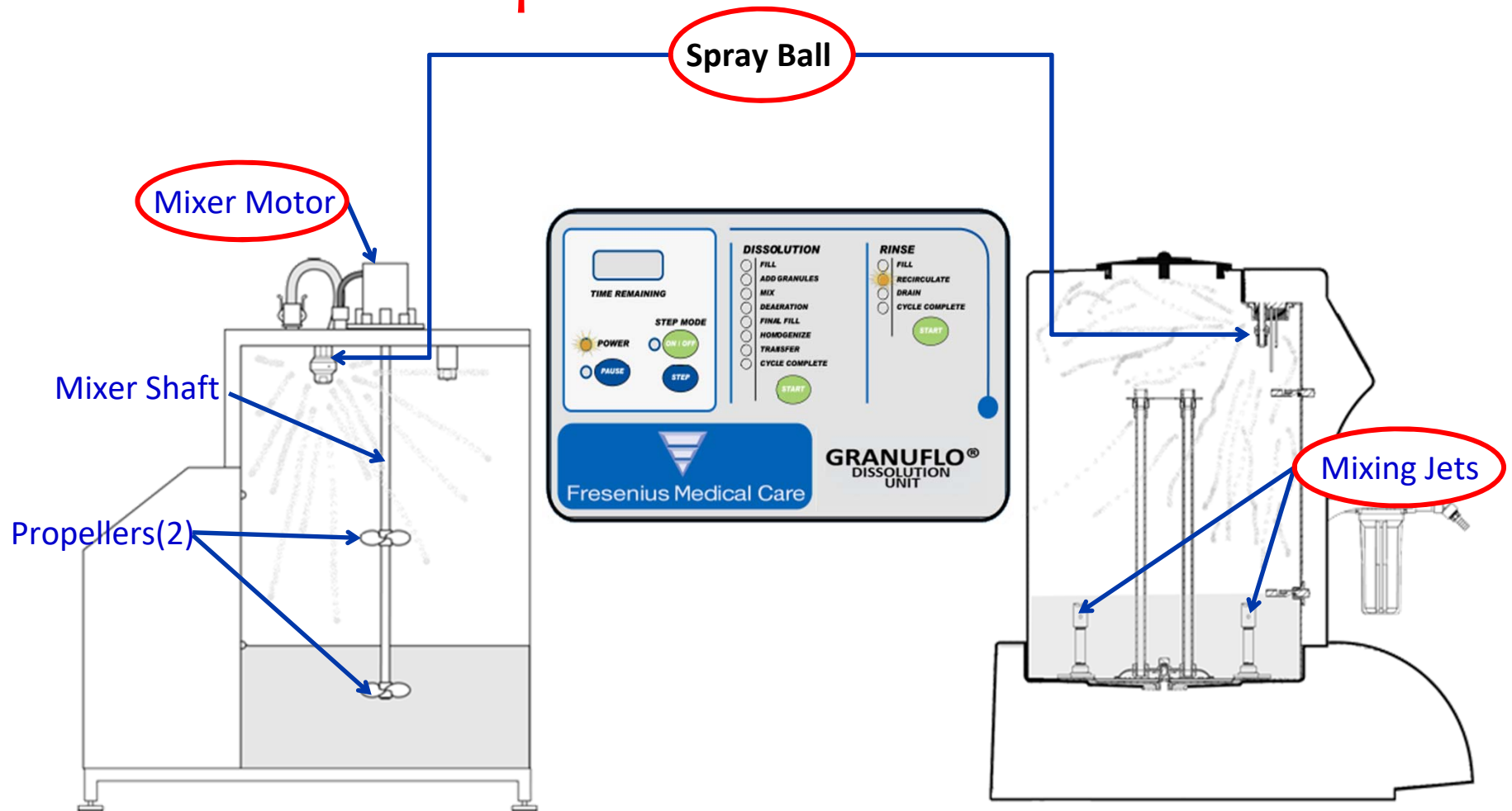

# Rinse Cycle (Mix Process – Step #2)

## Example

### DRAIN Operation

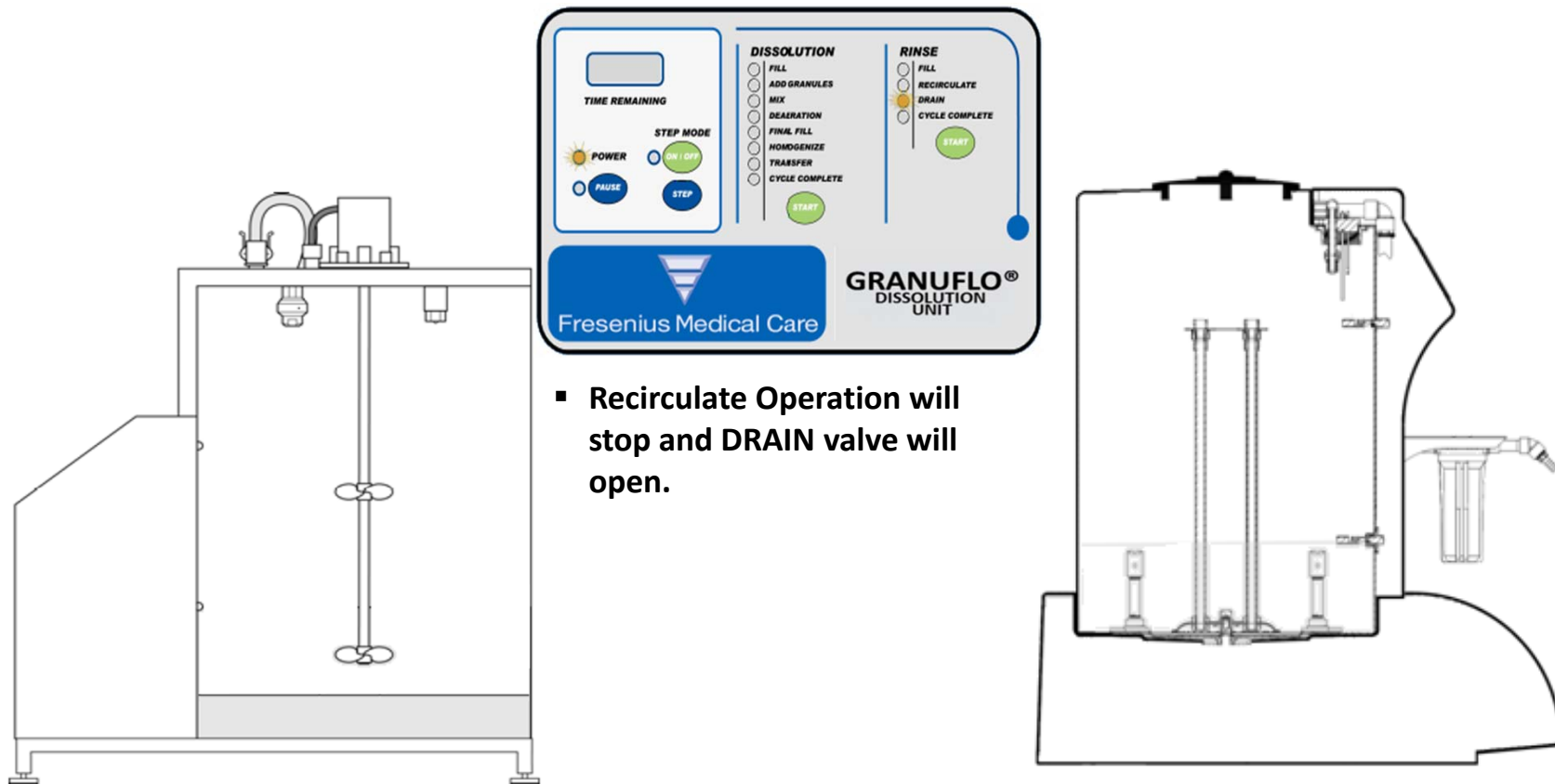

# Rinse Cycle (Mix Process – Step #2)

## Example

### FILL Operation

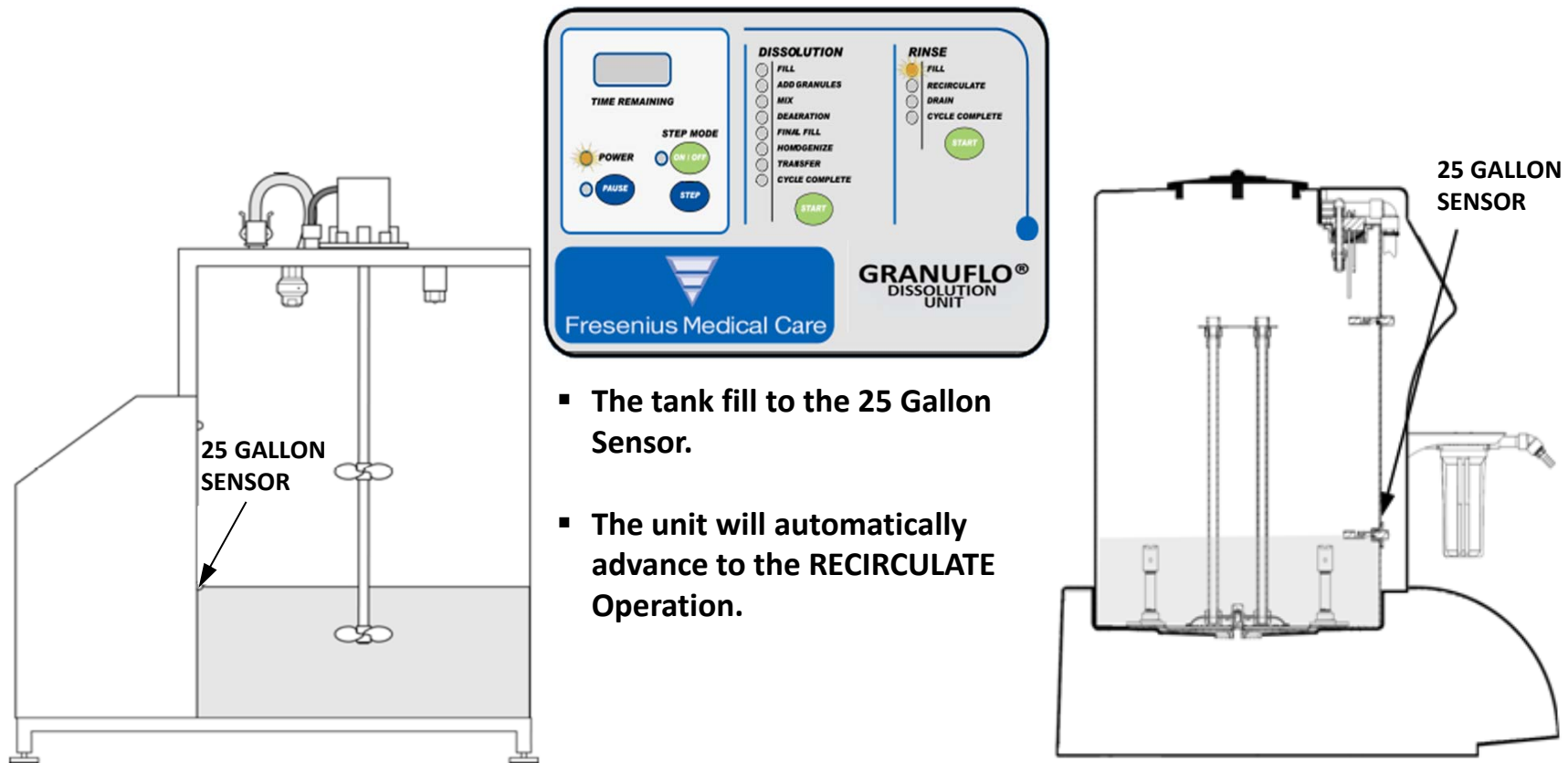

# Rinse Cycle (Mix Process – Step #2)

## Example

### RECIRCULATE Operation

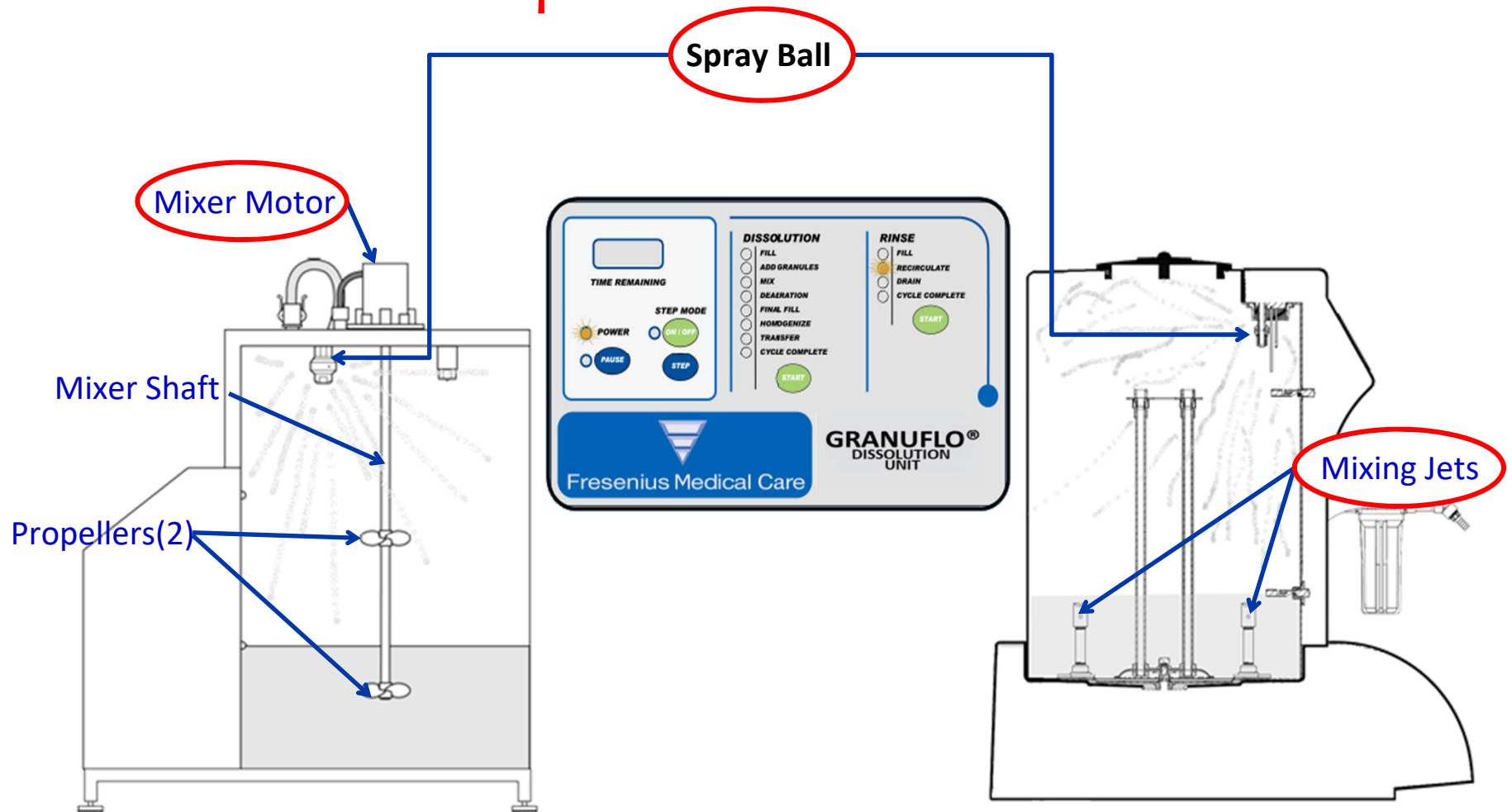

# Rinse Cycle (Mix Process – Step #2)

## Example

### DRAIN Operation

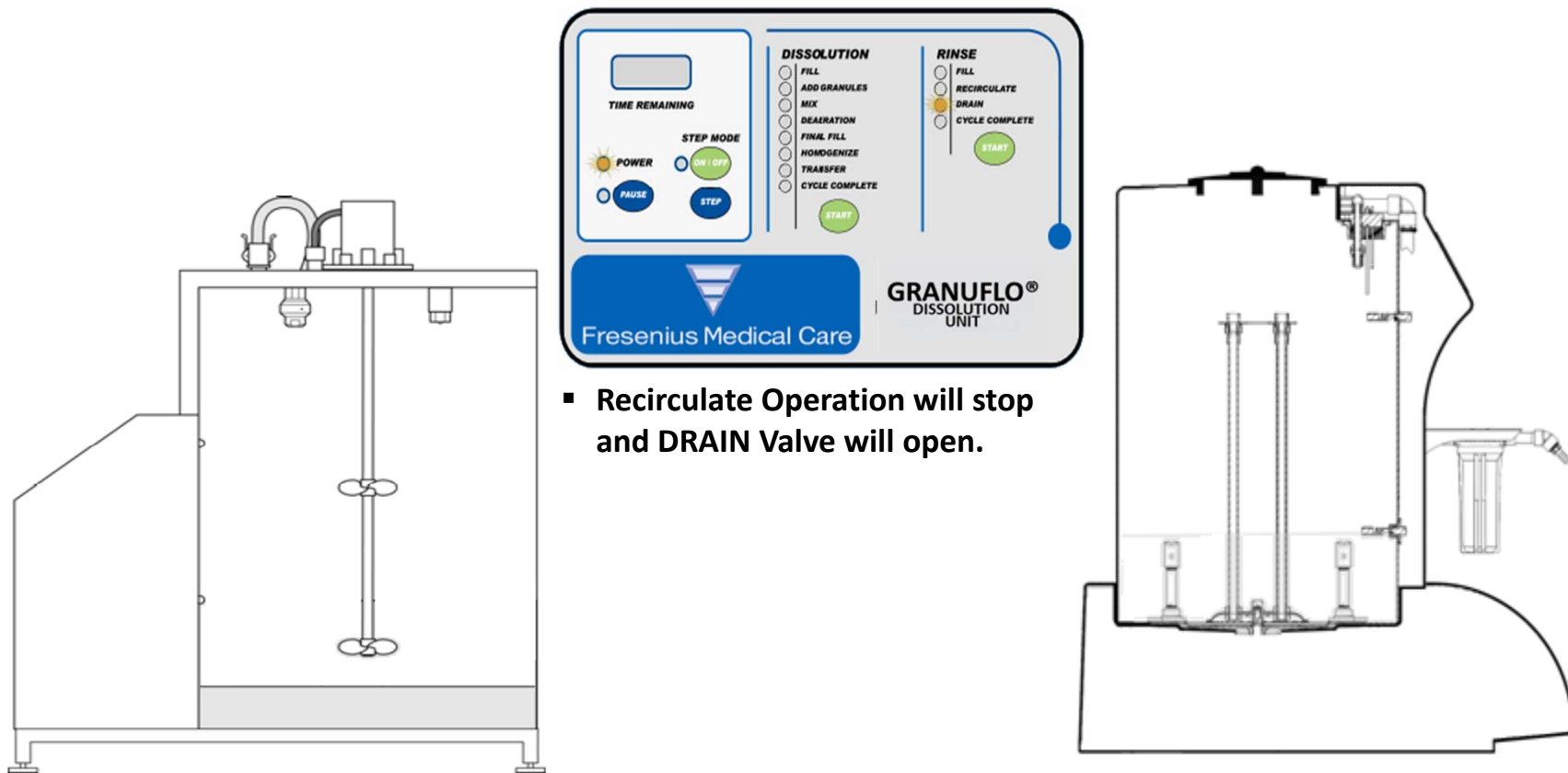



# Rinse Cycle (Mix Process – Step #2)

## Example

## CYCLE COMPLETE Operation

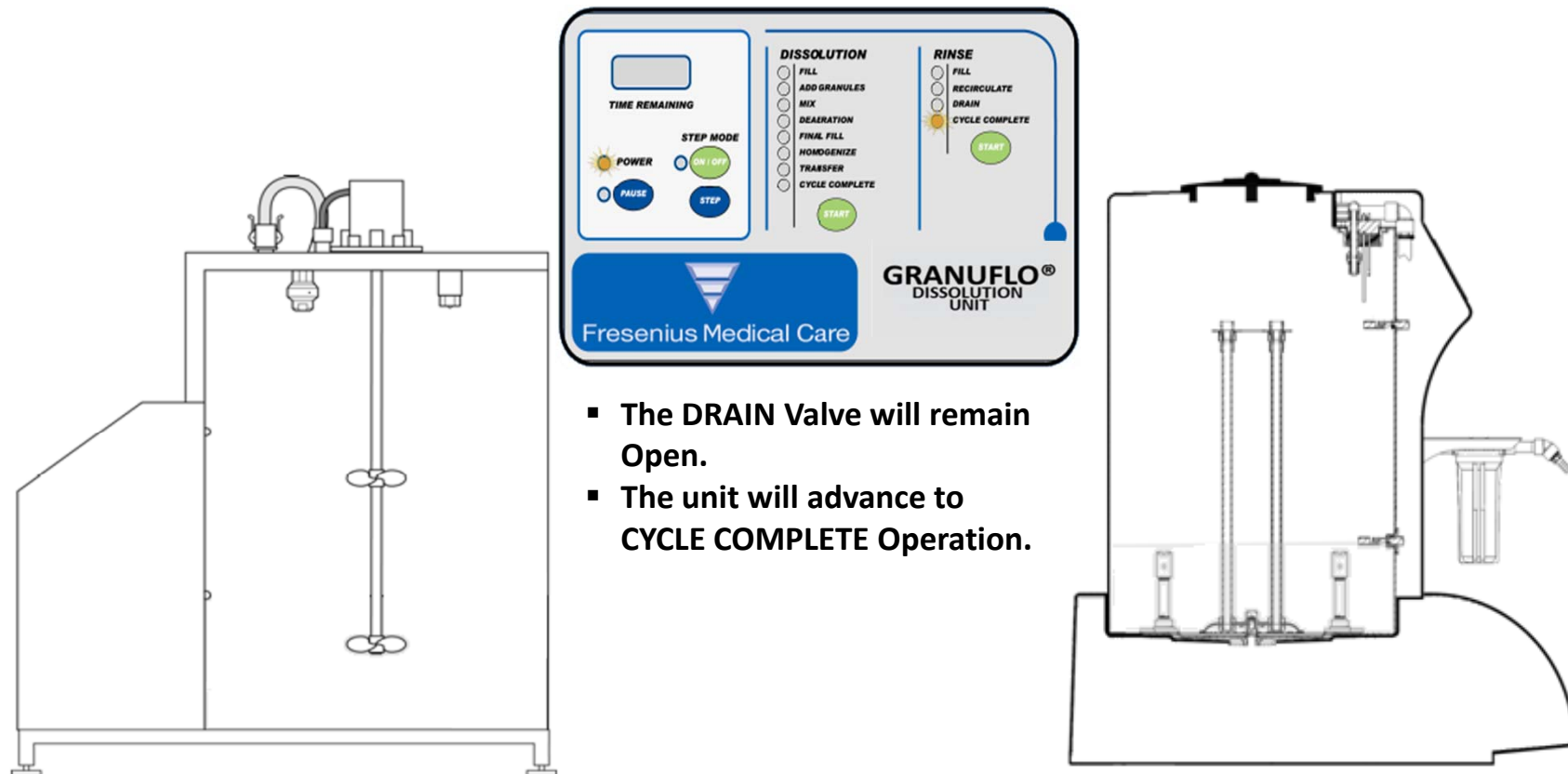

# DISSOLUTION CYCLE

## Step #3

**Operators Manual:**  
Section 7.0

# Dissolution Cycle (Mix Process – Step#3)

## Operators Manual Section 7.0

**NOTE:** A COMPLETE FULL RINSE CYCLE IS RECOMMENDED BEFORE MAKING BATCH OF CONCENTRATE.

**(ONLY for the GranuFlo II Unit)**

**NOTE:** A SHORT RINSE CYCLE IS PERFORMED AS PART OF THE DISSOLUTION CYCLE: FILL OPERATION, AND DRAIN IS INITIATED AND COMPLETED WHILE THE FILL INDICATOR LIGHT IS ILLUMINATED. THIS SHORTENED RINSE CYCLE SHOULD NOT BE MISTAKEN FOR A FULL RINSE CYCLE.

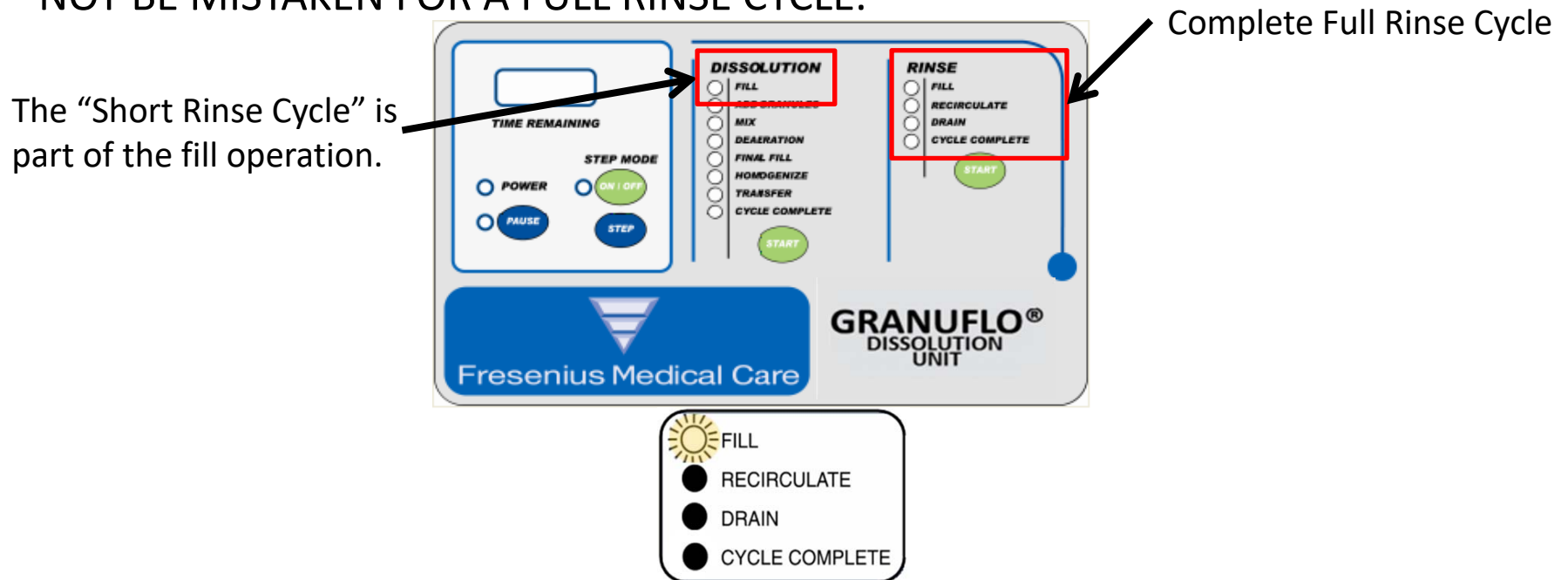

# Dissolution Cycle (Mix Process – Step#3)

## Operators Manual Section 7.0

### 1. Before initiation of Dissolution Cycle:

- Ensure the **tank is empty**.
- The **1 micron filter** is installed in the concentrate filter housing.
- Check for **Propellers** are attached to the Mixer Shaft (For 132 Gal. Unit).
- Ensure you have the appropriate **Personal Protective Equipment** donned.

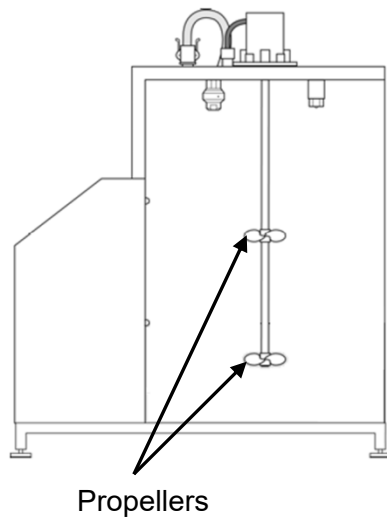

A) GranuFlo I Dissolution Unit

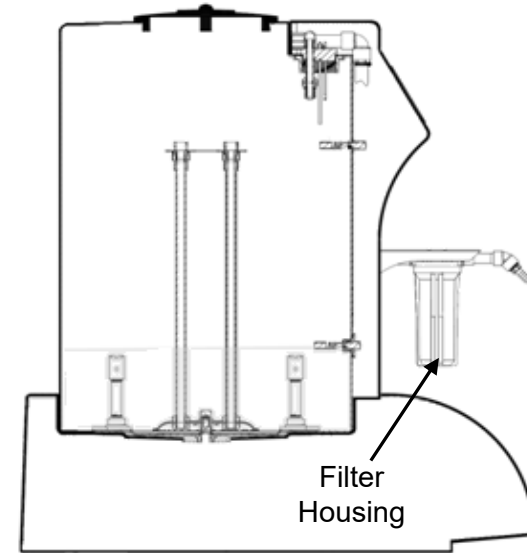
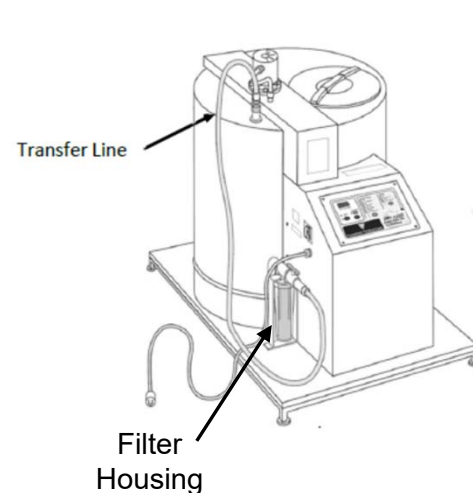

B) GranuFlo II Dissolution Unit

# Dissolution Cycle (Mix Process – Step#3)

## Operators Manual Section 7.0

2. Ensure **Power Switch is ON** and **Water Inlet Open** then place the GranuFlo Dissolution Unit in Dissolution Cycle FILL operation by pressing the Dissolution side **START** button.

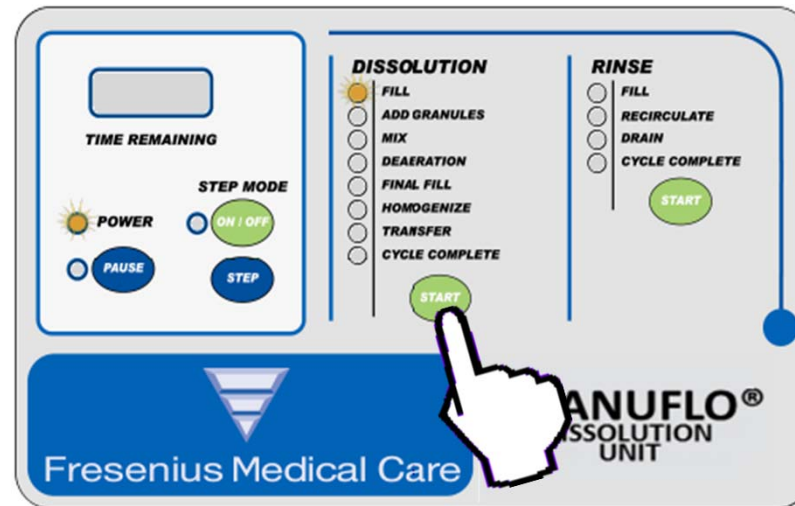

**NOTE:** The GranuFlo I Dissolution Unit will be in the **FILL** Operation until the water reaches to the Mid-Level Sensor.

**NOTE:** The GranuFlo II Dissolution Unit will do a short Recirculate Operation with only the Fill Indicator Light illuminated then fill to the Mid-Level Sensor.

# Dissolution Cycle (Mix Process – Step#3)

## Operators Manual Section 7.0

- When the Mid Water Level is reached.
  - The **Water inlet valve will Close.**
  - The **Add Granules Light** will begin to **flash.**
  - The Unit is in **PAUSE state** waiting for the operator to **ADD GRANULES.**

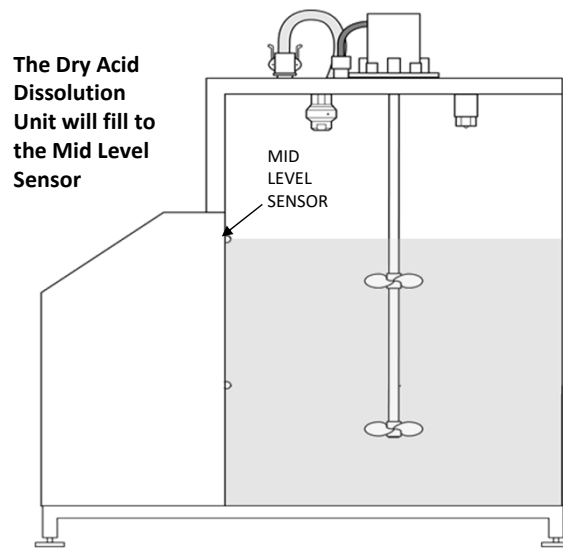

A) GranuFlo I Dissolution Unit

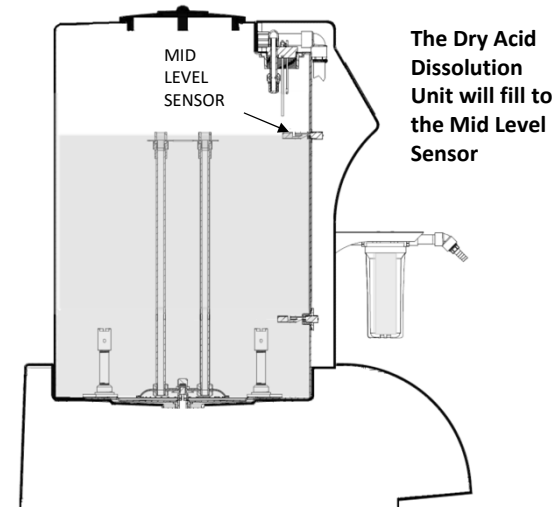

B) GranuFlo II Dissolution Unit

# Dissolution Cycle (Mix Process – Step#3)

## Operators Manual Section 7.0

4. Before adding Granules make sure to check the following:
  - Ensure that no water is leaking from underneath or any external connections to and from the GranuFlo Dissolution Unit. In addition, ensure there are no leaks at the end of the Drain Hose.
  - Remove the large access lid and ensure water has stopped at the Mid-Level Sensor.
  - Depending on the input water pressure you may have to wait several minutes to verify the water does not rise above the Mid-Level Sensor.
  - Proceed to **ADD GRANULES**.

# DISSOLUTION CYCLE ADD GRANULES

## PROCEDURE CARD



# Dissolution Cycle

## Add Granules

- Determine how much product is required.

FMCNA Dissolution Unit	No. of Cases Needed
GranuFlo II Dissolution Unit	6
GranuFlo I Dissolution Unit	8

- Check case labels to ensure all cases have the same *Catalog Number* and *Potassium Number*.

### Recommendation:

- Group the cases to be used.
- Separate/isolate the group of cases from other cases that are present to avoid mixing Catalog No./ Products.

**3.0 K GRANUFLO® 3.0 Ca**  
**Naturalyte® Dry Acid Concentrate**  
**For Bicarbonate Dialysis**  
**45x**  
 62.5 LITER MIX (16.5 GAL)

**NON-PYROGENIC**

**WARNING:** Acid concentrate is formulated to be used in a three-stream hemodialysis machine calibrated to an acid concentrate dilution of 1:44. Use with other equipment may result in patient injury. **NOT FOR PARENTERAL USE.** For use only with Fresenius® 4500 Series bicarbonate or equivalent (refer to label). Use of this Acid Concentrate without associated bicarbonate concentrate may cause patient injury or death. Check conductivity and pH of dialysate just prior to dialysis treatment and each time new concentrate is applied to the machine.

**WARNING:** This acid concentrate product is for use as one component in mixing dialysate bath. This product contains sodium diacetate and, after mixing, yields 8 milliequivalents per liter of acetate in the dialysate. After diffusion across the dialyzer membrane, acetate is metabolized by the liver to serum bicarbonate and acids to the serum bicarbonate that separately results from the diffusion of dialysate bicarbonate across the dialyzer membrane. During dialysis, the dynamic of diffusion and concentration gradients prevent serum bicarbonate concentration from exceeding the dialysate bicarbonate concentration. The bicarbonate concentration of the dialysate is the bicarbonate setting on the dialysis machine, and is the bicarbonate dose prescribed by the physician. On Fresenius 2008 series hemodialysis machines, the bicarbonate dose may be set in a range between 20 and 40 milliequivalents per liter, but may be set in different ranges in other machines.

When the dialysis session terminates, acetate that has not yet been metabolized may remain in the blood and will be converted to serum bicarbonate after dialysis ceases, without possibility of diffusion out of the blood. The post dialysis metabolism of acetate could thus briefly increase serum bicarbonate concentration above the prescribed bicarbonate concentration of the dialysate. Physicians should consider this possibility in prescribing bicarbonate dose. Prescription of insufficient bicarbonate may contribute to metabolic acidosis; excessive bicarbonate may contribute to metabolic alkalosis. Both conditions are associated with poor patient outcomes, including increased mortality risk.

IONIC CONTRIBUTION OF ACID		CHEMICAL COMPOSITION	
CONCENTRATE: (Nominal Dilution 1:44)		Total	
<b>SODIUM</b>	100 mEq/L	<b>NaCl</b>	15.8 kg
<b>POTASSIUM</b>	3.0 mEq/L	<b>KCl</b>	0.629 kg
<b>CALCIUM</b>	3.0 mEq/L	<b>CaCl<sub>2</sub>*2H<sub>2</sub>O</b>	0.620 kg
<b>MAGNESIUM</b>	1.0 mEq/L	<b>MgCl<sub>2</sub>*6H<sub>2</sub>O</b>	0.286 kg
<b>ACETATE</b>	8.0 mEq/L	<b>CH<sub>3</sub>COONa-CH<sub>3</sub>COOH</b>	1.60 kg
<b>CHLORIDE</b>	103.00 mEq/L	<b>C<sub>6</sub>H<sub>12</sub>O<sub>6</sub>*H<sub>2</sub>O</b>	3.09 kg
<b>DEXTROSE</b>	100 mg/dL		

**DILUTION INSTRUCTIONS**  
 (The contents may clump or harden which does not affect product chemical composition)

- Use water that meets or exceeds current ANSI/AAMI hemodialysis water quality standards. Water temperature should be 20°–30° C to optimize dissolving.
- Add approximately 10 gallons of water to mixing container. Water and feed line must be free of bacterial and chemical contamination (ANSI/AAMI).
- Use entire contents of each bag (3) within this box. Do not use unless all (3) bags are present. The contents of the bags are different. All bags must be used. NOTE: Refer to Dissolution System Operator's Manual. Label tank with contents and date prepared.
- Add additional water to dissolution tank final fill level.
- Fully dissolved, this will make 62.5 liters (16.5 gal) of solution. Eight (8) cases of identical chemical composition produce 500 liters (132 gal). Six (6) cases make 375 liters (99 gal).
- Mix solution until completely dissolved. Filter with 1.2 micron filter or finer before use. Keep container sealed. Label and date all storage containers.

**CAUTION:** Refer to instructions provided by the hemodialysis machine manufacturer. Federal law (USA) restricts this device to sale by or on order of a physician.  
**AVOID EXCESSIVE TEMPERATURE. PROTECT FROM MOISTURE.**  
**DO NOT USE IF PACKAGE IS OPEN OR DAMAGED.**

**FRESENIUS MEDICAL CARE**  
 Fresenius Medical Care  
 Renal Therapies Group, LLC  
 Waltham, MA 02451  
 1-800-323-5188

Cat. No. 0FD3301-3B

Printed in USA 71-4310-09 09/14

# Dissolution Cycle

## Add Granules

### GranuFlo

Product Name: GRANUFLO



**3.0 K GRANUFLO 3.0 Ca**  
**Naturalyte® Dry Acid Concentrate**  
**For Bicarbonate Dialysis** **45x**  
**NON-PYROGENIC** **62.5 LITER MIX (16.5 GAL)**

**WARNING:** Acid concentrate is formulated to be used in a three-stream hemodialysis machine calibrated to an acid concentrate dilution of 1:44. Use with other equipment may result in subtherapeutic, NOT THERAPEUTICAL, USE, for one only with bicarbonate concentration or equipment (refer to label). Use of this Acid Concentrate without associated bicarbonate concentrate may cause patient injury or death. Check conductivity and pH of dialysate prior to dialysis treatment and each time new concentrate is supplied to the machine.

**WARNING:** This acid concentrate product is for use as one component in mixing dialysate bath. This product contains sodium acetate and, after mixing, results in milliequivalents per liter of acetate in the dialysate. After diffusion across the dialyzer membrane, acetate is metabolized by the liver to serum bicarbonate and acids in the serum bicarbonate that separately results from the diffusion of dialysate bicarbonate across the dialyzer membrane. During dialysis, the dynamic diffusion and concentration gradients prevent serum bicarbonate concentration from exceeding the dialysate bicarbonate concentration. The bicarbonate concentration of dialysate in the bicarbonate setting on the dialysis machine, and in the bicarbonate dose prescribed by the physician, on Fresenius 2008 series hemodialysis machines, the bicarbonate dose may be set in a range between 20 and 40 milliequivalents per liter, but may be set in different ranges in other machines.

When the dialysis session terminates, acetate that has not yet metabolized may remain in the blood and will be converted to serum bicarbonate after diffusion occurs, without possibility of diffusion out of the blood. The post-dialysis metabolism of acetate could thus briefly increase serum bicarbonate concentration above the prescribed bicarbonate concentration of the dialysis. Physicians should consider the possibility in prescribing bicarbonate dose. Prescription of insufficient bicarbonate may contribute to metabolic acidosis; excessive bicarbonate may contribute to metabolic alkalosis. Both conditions are associated with poor patient outcomes, including increased mortality risk.

IONIC CONTRIBUTION OF ACID CONCENTRATE: (Nominal Dilution 1:44)		CHEMICAL COMPOSITION Total	
<b>SODIUM</b>	100 mEq/L	<b>NaCl</b>	15.8 kg
<b>POTASSIUM</b>	3.0 mEq/L	<b>KCl</b>	0.629 kg
<b>CALCIUM</b>	3.0 mEq/L	<b>CaCl<sub>2</sub>·2H<sub>2</sub>O</b>	0.620 kg
<b>MAGNESIUM</b>	1.0 mEq/L	<b>MgCl<sub>2</sub>·6H<sub>2</sub>O</b>	0.286 kg
<b>ACETATE</b>	8.0 mEq/L	<b>CH<sub>3</sub>COONa-CH<sub>3</sub>COOH</b>	1.60 kg
<b>CHLORIDE</b>	103.00 mEq/L	<b>C<sub>6</sub>H<sub>12</sub>O<sub>6</sub>·H<sub>2</sub>O</b>	3.09 kg
<b>DEXTRROSE</b>	100 mg/dL		

**DILUTION INSTRUCTIONS**  
 (The contents may clump or harden which does not affect product chemical composition.)

- 1) Use water that meets or exceeds current ANSI/AAMI hemodialysis water quality standards. Water temperature should be 20°–30° C to optimize dissolving.
- 2) Add approximately 10 gallons of water to mixing container. Water and feed line must be free of bacterial and chemical contamination (ANSI/AAMI).

**IMPORTANT:**

- 3) Use entire contents of each bag (3) within this box. Do not use unless all (3) bags are present. The contents of the bags are different. All bags must be used.
- NOTE: Refer to Dissolution System Operator's Manual. Label bag with contents and date prepared.
- 4) Add additional water to dissolution tank final fill level.
- 5) Fully dissolved, this will make 62.5 liters (16.5 gal) of solution. Eight (8) cases of identical concentrate produce 500 liters (132 gal). Six (6) cases make 375 liters (99 gal).
- 6) Mix solution until completely dissolved. Filter with 1.2 micron filter or finer before use. Keep container sealed. Label and date all storage containers.

**CAUTION:** Refer to instructions provided by the hemodialysis machine manufacturer. Federal law (USA) restricts this device to sale by or on order of a physician.

**AVOID EXCESSIVE TEMPERATURE. PROTECT FROM MOISTURE. DO NOT USE IF PACKAGE IS OPEN OR DAMAGED.**

**FRESENIUS MEDICAL CARE**  
 Fresenius Medical Care  
 Renal Therapies Group, LLC  
 Waltham, MA 02451  
 1-800-323-5108

Cat. No. 0FD3301-3B

Printed in USA 71-4310.03 09/14

Label Graphic: Red

### Citrasate Dry

Product Name: CITRASATE DRY

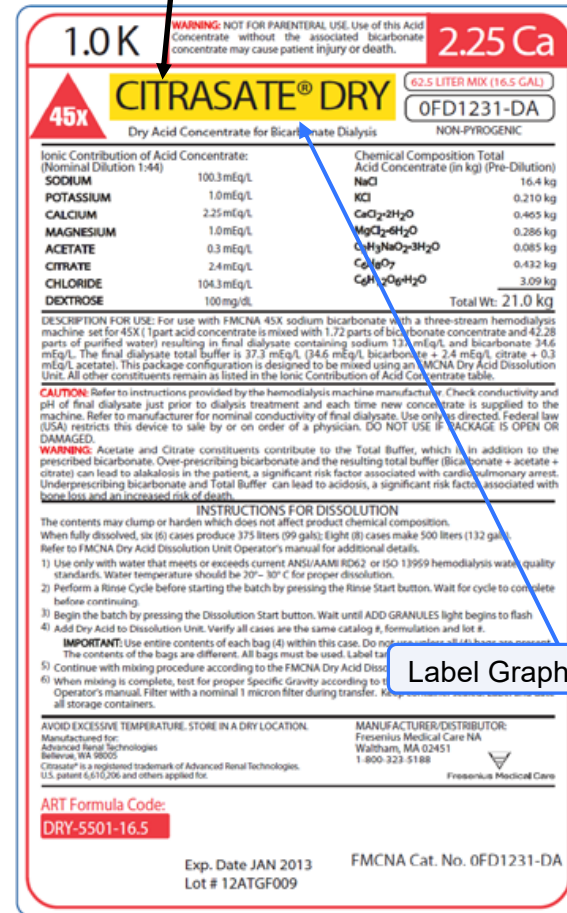

**1.0K CITRASATE® DRY 2.25 Ca**  
**Dry Acid Concentrate for Bicarbonate Dialysis** **45x**  
**NON-PYROGENIC** **62.5 LITER MIX (16.5 GAL)**

**WARNING:** NOT FOR PARENTERAL USE. Use of this Acid Concentrate without the associated bicarbonate concentrate may cause patient injury or death.

Ionic Contribution of Acid Concentrate: (Nominal Dilution 1:44)		Chemical Composition Total Acid Concentrate (in kg) (Pre-Dilution)	
<b>SODIUM</b>	100.0 mEq/L	<b>NaCl</b>	16.4 kg
<b>POTASSIUM</b>	1.0 mEq/L	<b>KCl</b>	0.210 kg
<b>CALCIUM</b>	2.25 mEq/L	<b>CaCl<sub>2</sub>·2H<sub>2</sub>O</b>	0.465 kg
<b>MAGNESIUM</b>	1.0 mEq/L	<b>MgCl<sub>2</sub>·6H<sub>2</sub>O</b>	0.286 kg
<b>ACETATE</b>	0.3 mEq/L	<b>C<sub>6</sub>H<sub>12</sub>O<sub>6</sub>·H<sub>2</sub>O</b>	0.085 kg
<b>CITRATE</b>	2.4 mEq/L	<b>C<sub>6</sub>H<sub>5</sub>O<sub>7</sub></b>	0.432 kg
<b>CHLORIDE</b>	104.3 mEq/L	<b>C<sub>6</sub>H<sub>12</sub>O<sub>6</sub>·H<sub>2</sub>O</b>	3.09 kg
<b>DEXTRROSE</b>	100 mg/dL		

**Total Wt: 21.0 kg**

**DESCRIPTION FOR USE:** For use with FMCNA 45X sodium bicarbonate with a three-stream hemodialysis machine set for 45X (1 part acid concentrate is mixed with 1.72 parts of bicarbonate concentrate and 42.28 parts of purified water) resulting in final dialysate containing sodium 100 mEq/L and bicarbonate 34.6 mEq/L. The final dialysate total buffer is 27.3 mEq/L (34.6 mEq/L bicarbonate + 2.4 mEq/L citrate + 0.3 mEq/L acetate). This package configuration is designed to be mixed using an FMCNA Dry Acid Dissolution Unit. All other constituents remain as listed in the Ionic Contribution of Acid Concentrate table.

**CAUTION:** Refer to instructions provided by the hemodialysis machine manufacturer. Check conductivity and pH of final dialysate just prior to dialysis treatment and each time new concentrate is supplied to the machine. Refer to manufacturer for nominal conductivity of final dialysate. Use only as directed. Federal law (USA) restricts this device to sale by or on order of a physician. DO NOT USE IF PACKAGE IS OPEN OR DAMAGED.

**WARNING:** Acetate and Citrate constituents contribute to the Total Buffer, which in addition to the prescribed bicarbonate. Over-prescribing bicarbonate and the resulting total buffer (bicarbonate + acetate + citrate) can lead to alkalosis in the patient, a significant risk factor associated with cardiovascular + pulmonary arrest. Under-prescribing bicarbonate and Total Buffer can lead to acidosis, a significant risk factor associated with bone loss and an increased risk of death.

**INSTRUCTIONS FOR DISSOLUTION**  
 The contents may clump or harden which does not affect product chemical composition.

- 1) When fully dissolved, six (6) cases produce 375 liters (99 gal). Eight (8) cases make 500 liters (132 gal). Refer to FMCNA Dry Acid Dissolution Unit Operator's manual for additional details.
- 2) Use only with water that meets or exceeds current ANSI/AAMI R062 or ISO 13959 hemodialysis water quality standards. Water temperature should be 20°–30° C for proper dissolution.
- 3) Perform a Rinse Cycle before starting the batch by pressing the Rinse Start button. Wait for cycle to complete before continuing.
- 4) Begin the batch by pressing the Dissolution Start button. Wait until ADD GRANULES light begins to flash.
- 5) Add Dry Acid to Dissolution Unit. Verify all cases are the same catalog #, formulation and lot #.
- 6) **IMPORTANT:** Use entire contents of each bag (4) within this case. Do not use unless all (4) bags are present. The contents of the bags are different. All bags must be used. Label all storage containers.
- 7) Continue with mixing procedure according to the FMCNA Dry Acid Dissolution Unit Operator's manual. Filter with a nominal 1 micron filter during transfer.

**AVOID EXCESSIVE TEMPERATURE. STORE IN A DRY LOCATION.**  
 Manufactured for:  
 Advanced Renal Technologies  
 Bellevue, WA 98005  
 Citrasate® is a registered trademark of Advanced Renal Technologies.  
 U.S. patent 6,610,206 and others applied for.

**MANUFACTURER/DISTRIBUTOR:**  
 Fresenius Medical Care NA  
 Waltham, MA 02451  
 1-800-323-5188

**ART Formula Code:**  
**DRY-5501-16.5**

Exp. Date JAN 2013  
 Lot # 12ATGF009

FMCNA Cat. No. 0FD1231-DA

Label Graphic: Yellow

# Dissolution Cycle

## Add Granules

- Fill in the Production Record Form, attached to the Operators Manual.
- Depending on product, Granuflo or Citrasate Dry Form.

**Record The Following Information Depending on the Product.**

**CITRASATE DRY BATCH PRODUCTION FORM**

Dialysis Unit Name & Location #:		Dry Acid Dissolution Unit Serial #:	
<b>DRY ACID PRODUCT CASE INFORMATION</b>			
OPERATOR (print name):		DATE:	TIME:
Batch #:			
CASE 1: Dry Acid Catalog # (label on box)	BOX Lot #	4 <sup>th</sup> bag used ✓ box Yes <input type="checkbox"/>	Potassium # (1K, 2K, 3K)
CASE 2: Dry Acid Catalog #	BOX Lot #	4 <sup>th</sup> bag used ✓ box Yes <input type="checkbox"/>	Potassium #
CASE 3: Dry Acid Catalog #	BOX Lot #	4 <sup>th</sup> bag used ✓ box Yes <input type="checkbox"/>	Potassium #
CASE 4: Dry Acid Catalog #	BOX Lot #	4 <sup>th</sup> bag used ✓ box Yes <input type="checkbox"/>	Potassium #
CASE 5: Dry Acid Catalog #	BOX Lot #	4 <sup>th</sup> bag used ✓ box Yes <input type="checkbox"/>	Potassium #
CASE 6: Dry Acid Catalog #	BOX Lot #	4 <sup>th</sup> bag used ✓ box Yes <input type="checkbox"/>	Potassium #
1. After Final Fill Level has been reached, turned OFF water valve to the Unit. Once this is done check the box <input type="checkbox"/>			
<b>SPECIFIC GRAVITY</b>			
Measured Temp	Print Catalog # - Specific Gravity Value for the Measured Temp listed in Appendix A:		Measured Specific Gravity Value:
TEMP:	LOW:	HIGH:	
			<input type="checkbox"/> Pass <input type="checkbox"/> Fail (void section)
OPERATOR SIGNATURE:		VERIFIER SIGNATURE:	

# Dissolution Cycle (Mix Process – Step#3)

Add Granules

## PPE

(Personal Protective Equipment is required/ recommended)

### Required



### Recommended



**Gloves**

**For more information refer to the MSDS form of the Dry Acid Product.**

# Dissolution Cycle (Mix Process – Step#3)

## Operators Manual Section 7.0

- A) Open a case of Citrasate® DRY / GranuFlo®.
- B) Cut off the top of 1 bag just below the bag seal.
- C) Remove the GranuFlo Dissolution Unit Small Access Lid and slowly add granules as seen in Figure.
- D) Before proceeding with the next case, repeat the steps B and C until all the bags of the case have been added.

### **Remember:**

- Use 6 cases for the 99 Gallon Unit
- Use 8 cases for the 132 Gallon Unit

All cases must have same FMCNA  
Catalog Number.

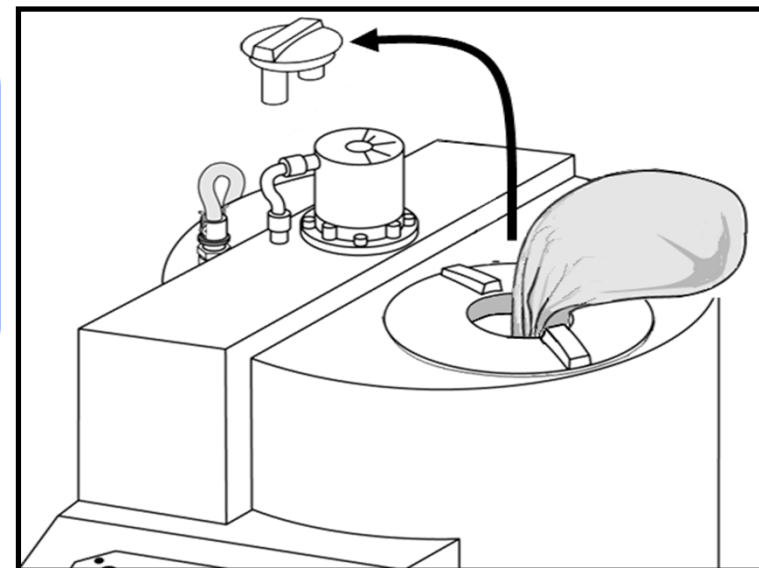

**Figure.** Add Granules

# Dissolution Cycle (Mix Process – Step#3)

## Operators Manual Section 7.0

5. On the **GranuFlo I Dissolution Unit**, After the Dry Acid Concentrate has been added, dry off the Upper Level Sensor of any splashing that may have occurred during the add granules process (Figure 10). Then reinstall the Small Access Lid and press the Dissolution **START** button

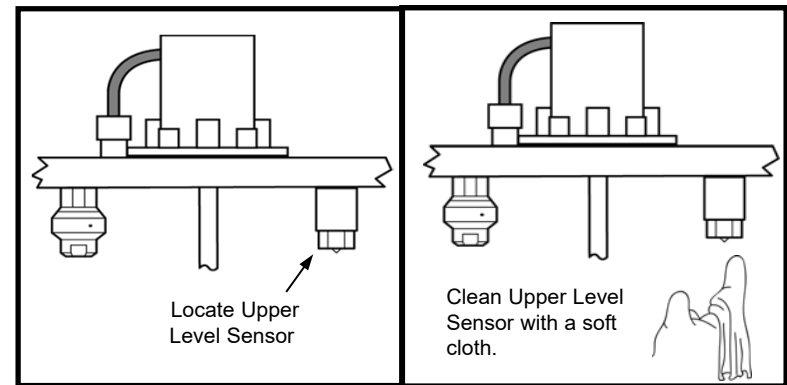
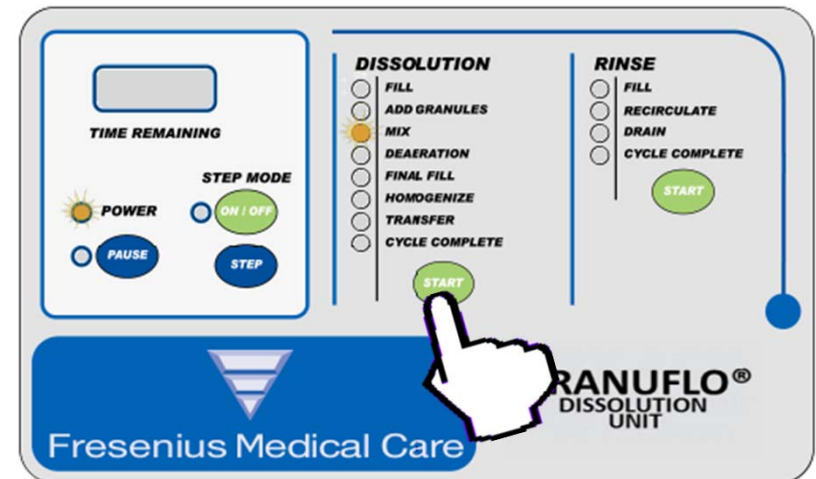

Figure 10. Clean Sensor

On the **GranuFlo II Dissolution Unit**, After adding all bags of Dry Acid, reinstall Small Access Lid, then press the Dissolution **START** button.

Both GranuFlo Dissolution Units will proceed to the **MIX** operation.



# Dissolution Cycle (Mix Process – Step#3)

## Operators Manual Section 7.0

6. For the **GranuFlo I Dissolution Unit**, during the **MIX** operation, the solution is mixed for a period of forty-five **(45) minutes** allowing the granules to completely dissolve. The GranuFlo Dissolution Unit will then automatically step to the DEAERATION Operation.

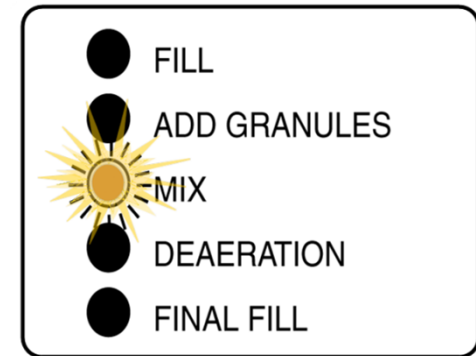

For the **GranuFlo II Dissolution Unit**, during the **MIX** operation, the solution is mixed for a period of thirty-five **(35) minutes** allowing the granules to completely dissolve. The GranuFlo Dissolution Unit will then automatically step to the DEAERATION Operation.

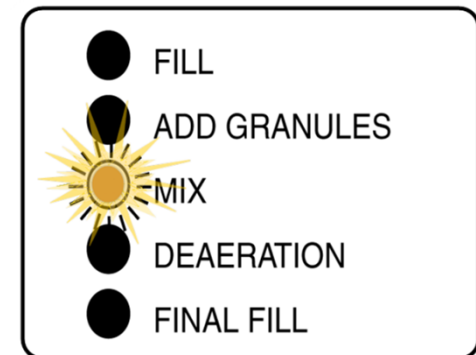

# Dissolution Cycle (Mix Process – Step#3)

## Operators Manual Section 7.0

7. For the **GranuFlo I Dissolution Unit**, the **DEAERATION** operation runs for **five (5) minutes** during which the entrapped air is allowed to separate out of the solution. Upon completion, the GranuFlo Dissolution Unit will automatically step to FINAL FILL operation and the Final Fill Indicator Light will illuminate.

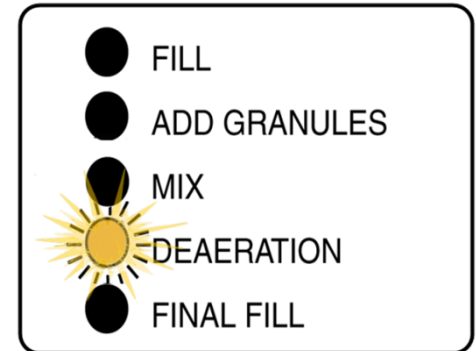

For the **GranuFlo II Dissolution Unit**, the **DEAERATION** operation runs for **two (2) minutes** during which the entrapped air is allowed to separate out of the solution. Upon completion, the GranuFlo Dissolution Unit will automatically step to FINAL FILL operation and the Final Fill Indicator Light will illuminate.

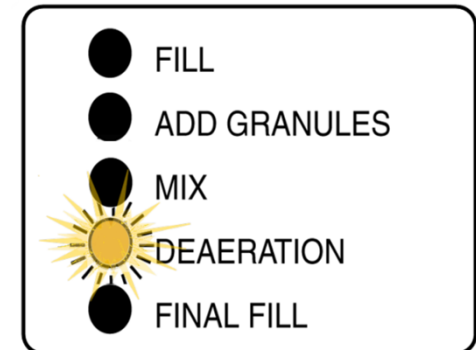



# Dissolution Cycle (Mix Process – Step#3)

## Operators Manual Section 7.0

8. In the **FINAL FILL** operation, the supply water valve will open and GranuFlo Dissolution Unit will fill to the Final Fill sensor.

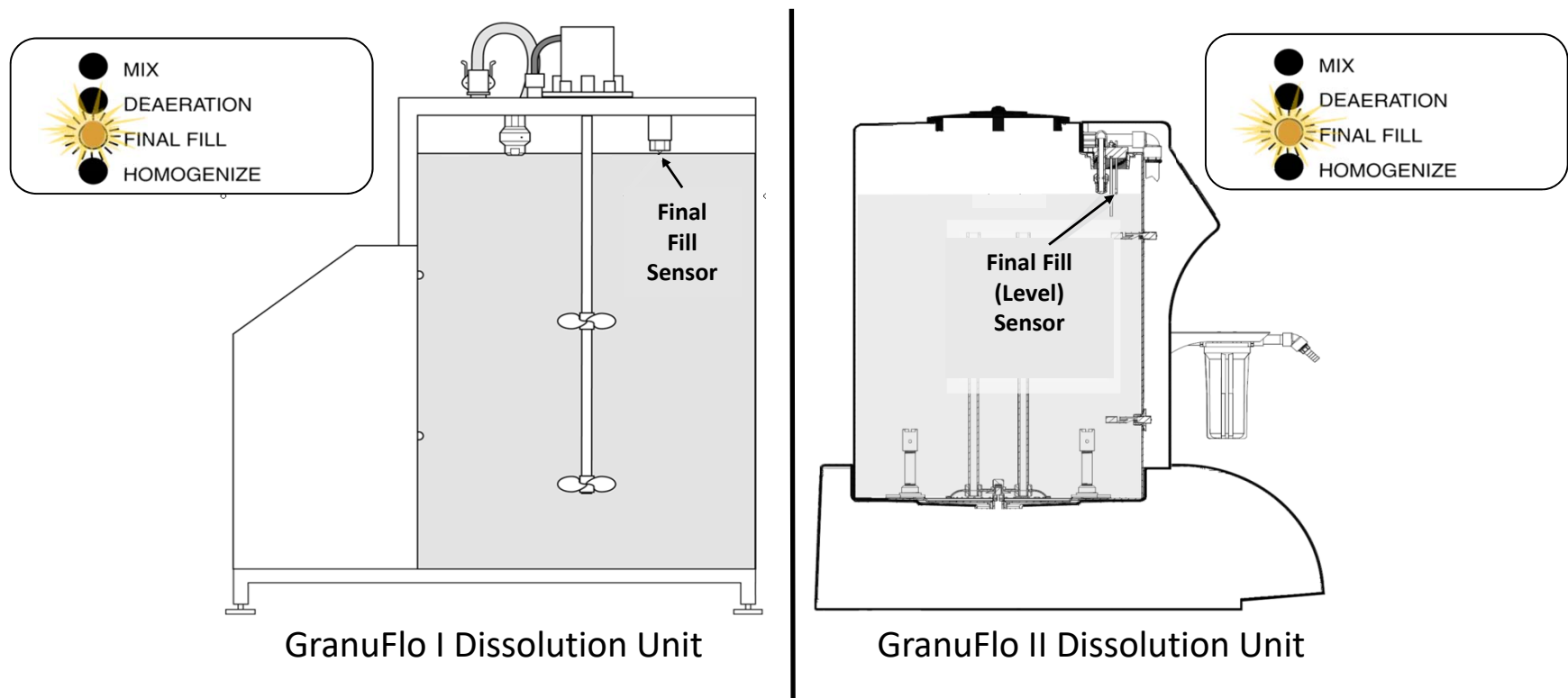
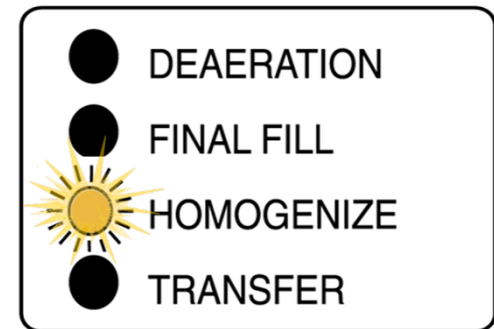

Figure. Final Fill

# Dissolution Cycle (Mix Process – Step#3)

## Operators Manual Section 7.0

9. When the final water level is reached, the unit will automatically step to **HOMOGENIZE** operation. Remove the Large Access Lid and **ensure the solution level has reached the Final Fill Sensor**. Place Large Access Lid onto the GranuFlo Dissolution Unit. **Then, CLOSE the water supply valve** to the GranuFlo Dissolution Unit.



10. During **HOMOGENIZE** operation, the mixer motor will stir the solution for ten (10) minutes. When the HOMOGENIZE Operation is complete, the Transfer Indicator Light will flash. Remove Large Access Lid and look into the tank to make sure the granules have dissolved and the solution is colorless. Once you have verified the granules are dissolved and colorless, **the solution is ready for Specific Gravity Testing**.

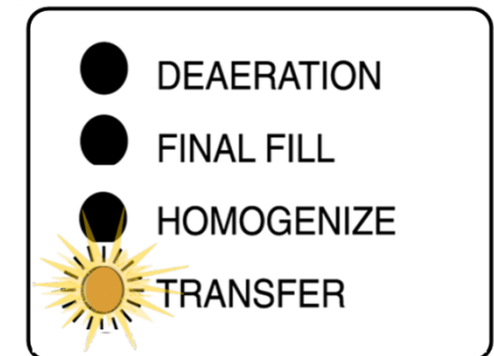

# Dissolution Cycle (Mix Process – Step#3)

## Example 132 - Gal

# Dissolution Cycle (Mix Process – Step#3)

Example 132 - Gal

## FILL Operation

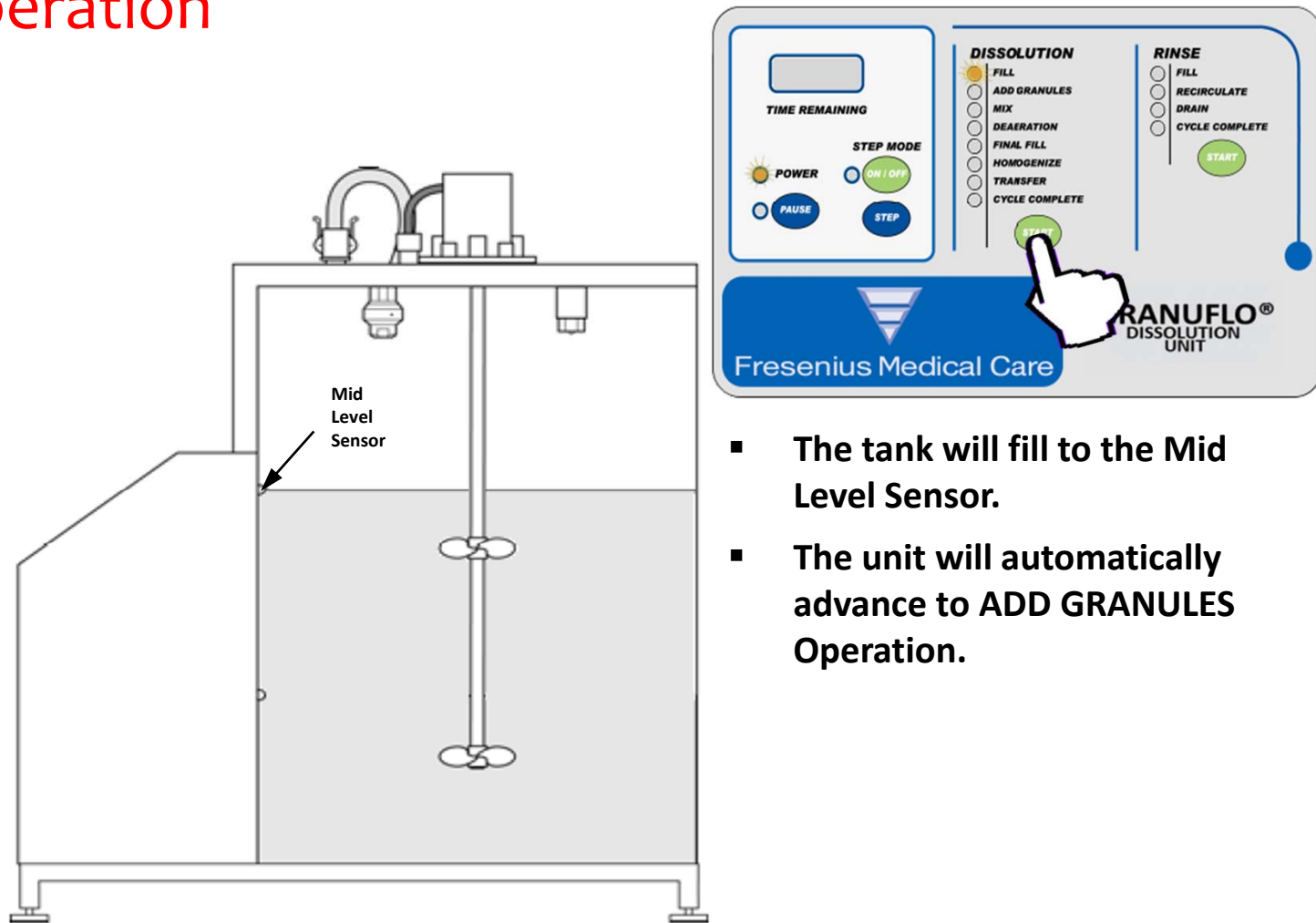

- The tank will fill to the Mid Level Sensor.
- The unit will automatically advance to ADD GRANULES Operation.

# Dissolution Cycle (Mix Process – Step#3)

Example 132 - Gal

## ADD GRANULES Operation

- Remove the Small Dissolution Tank Lid and slowly add granules.

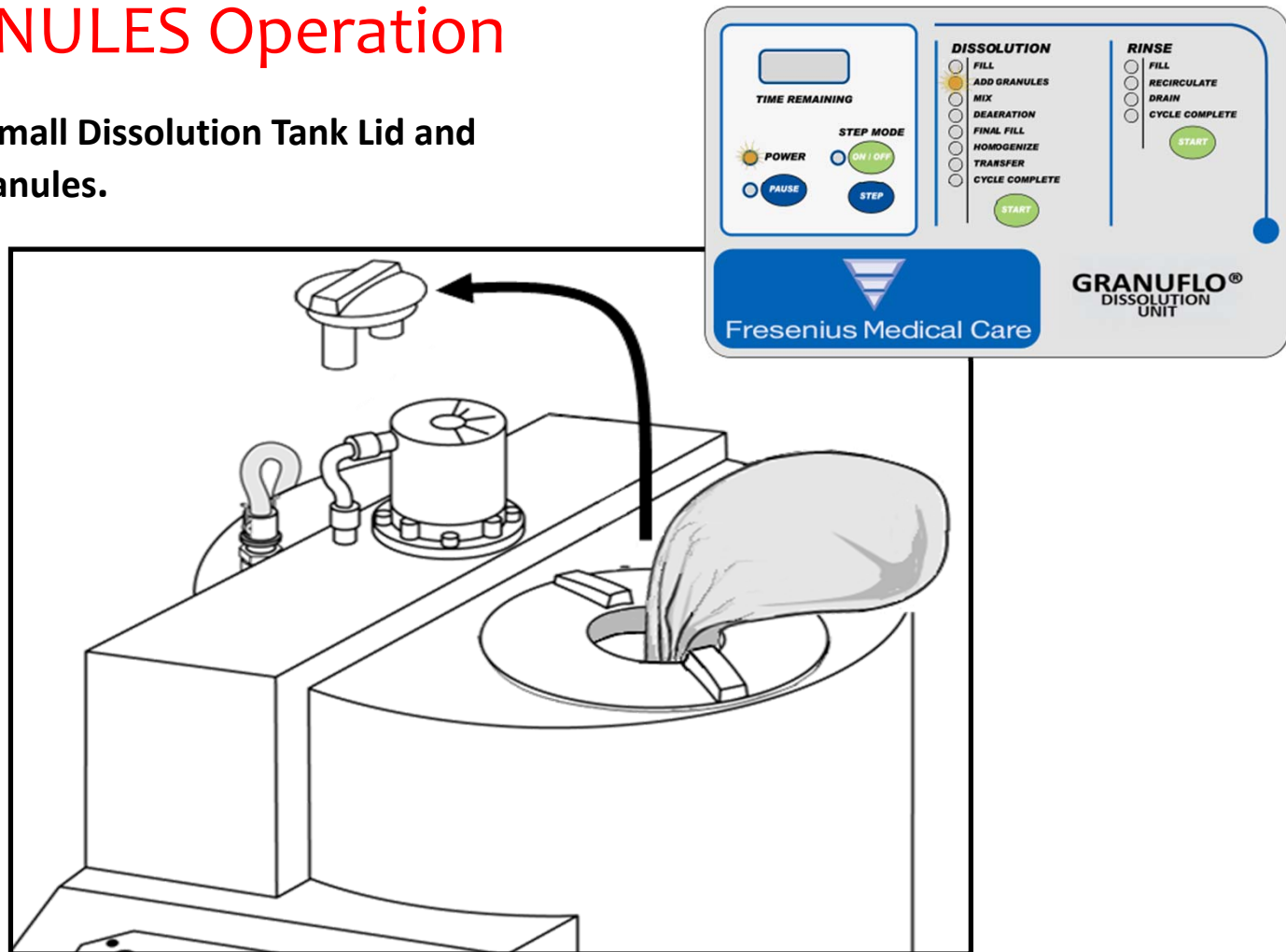

# Dissolution Cycle (Mix Process – Step#3)

Example 132 - Gal

## MIX Operation

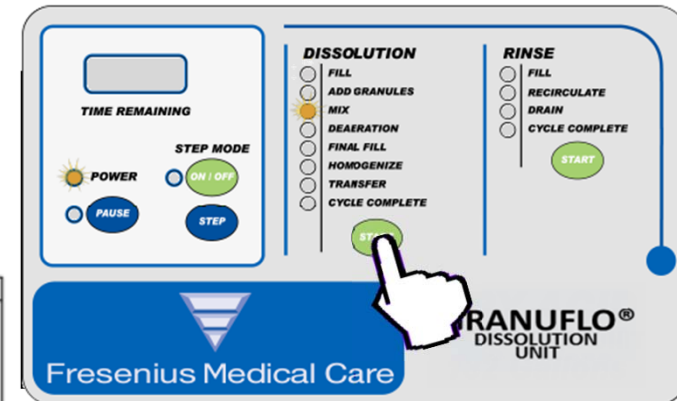
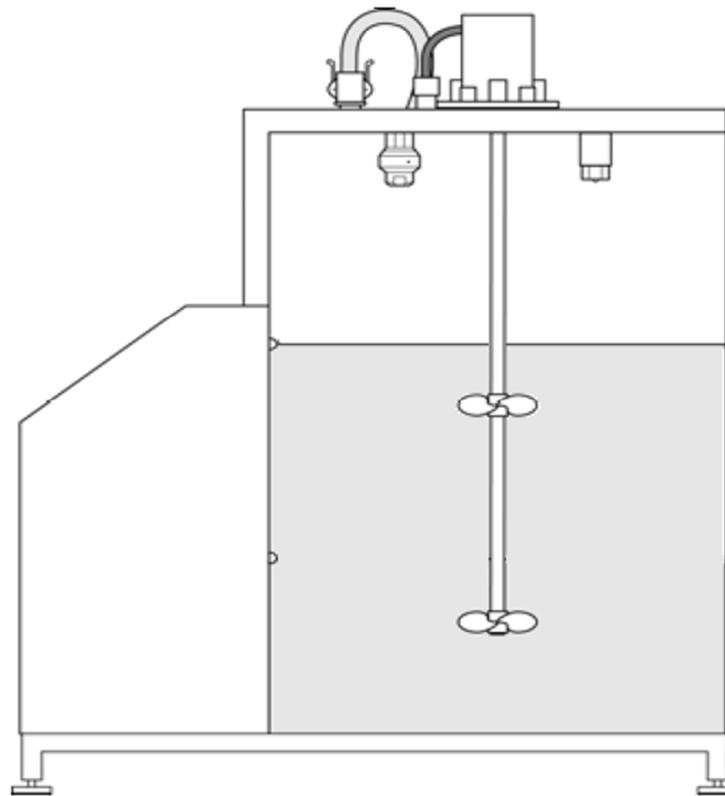

- Press the START button.
- The mix motor will run for 45 minutes.

**NOTE:** In the 99 Gallon GranuFlo II Unit the mix will run for 35 minutes.

# Dissolution Cycle (Mix Process – Step#3)

Example 132 - Gal

## DEAERATION Operation

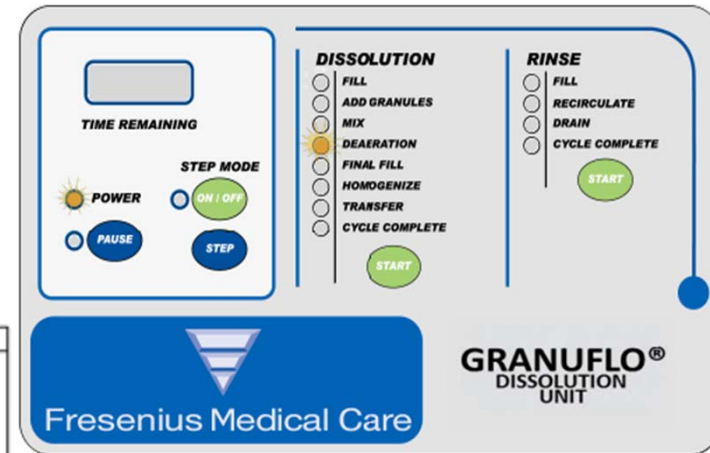
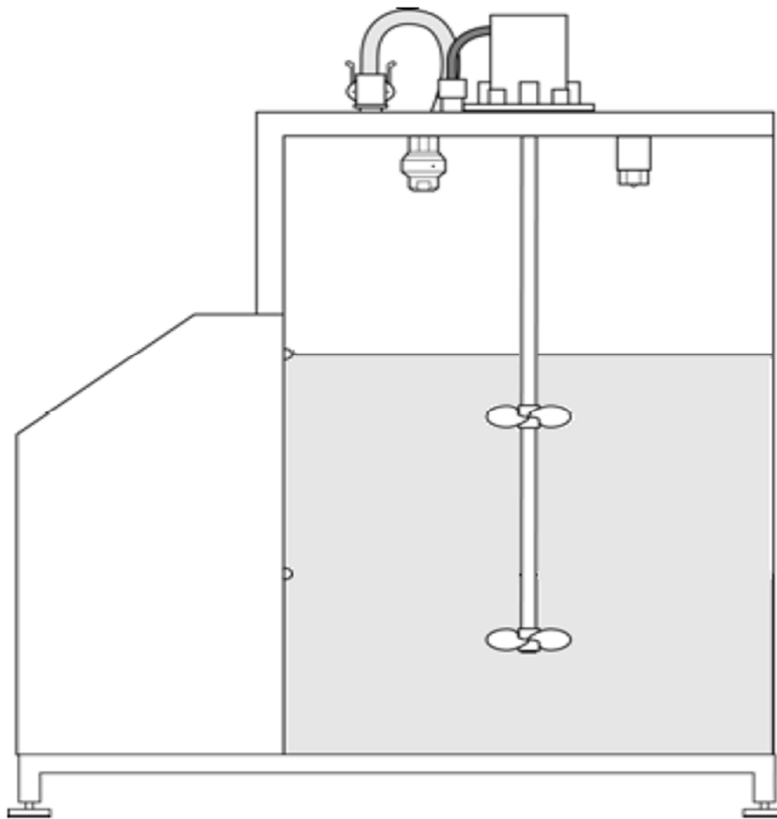

- **DEAERATION Operation**
- **During this (5) minute operation the Mixer Motor stops to allow air bubbles to separate out of the solution.**

**NOTE: In the 99 Gallon GranuFlo II Unit the DEAERATION Operation will run for 2 minutes.**

# Dissolution Cycle (Mix Process – Step#3)

Example 132 - Gal

## FINAL FILL Operation

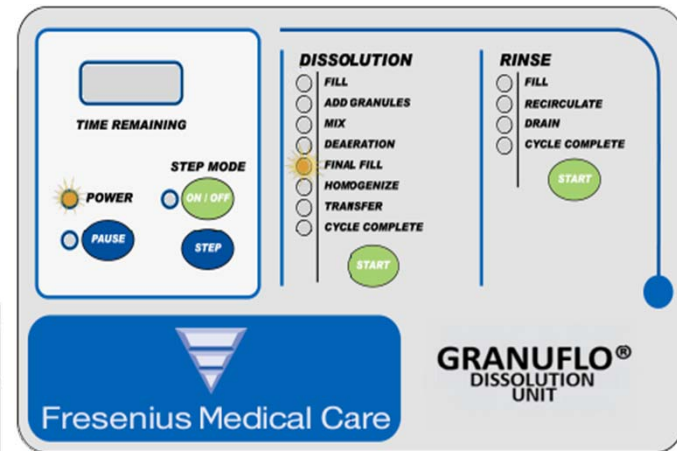
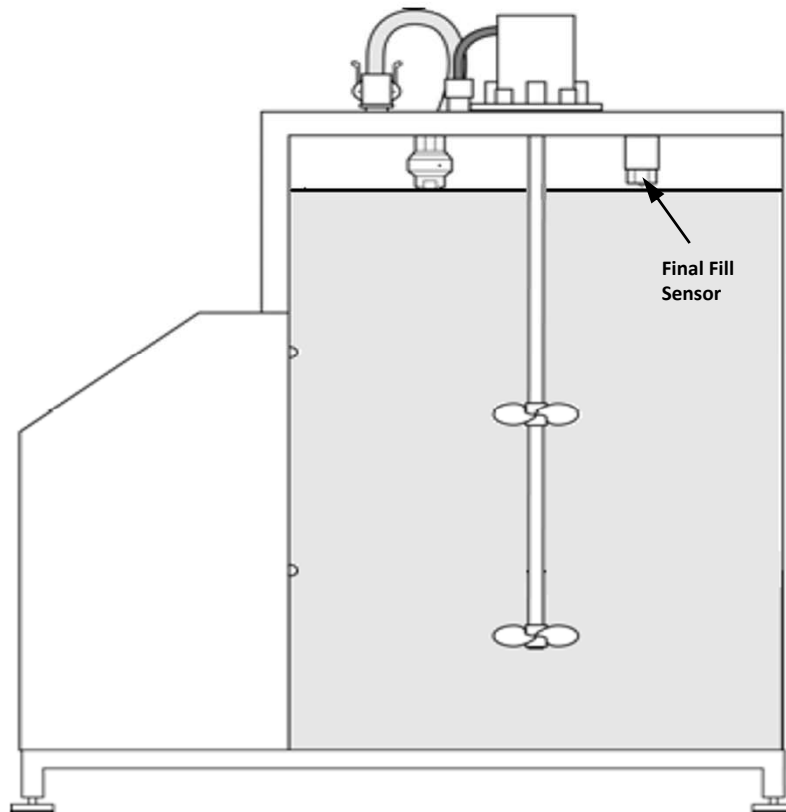

- **FINAL FILL Operation**
- **During this Operation, the Dissolution Tank is filled with treated water up to the Final Fill Sensor. Then, the unit automatically advance to the HOMOGENIZE Operation.**



# Dissolution Cycle (Mix Process – Step#3)

Example 132 - Gal

## HOMOGENIZE Operation

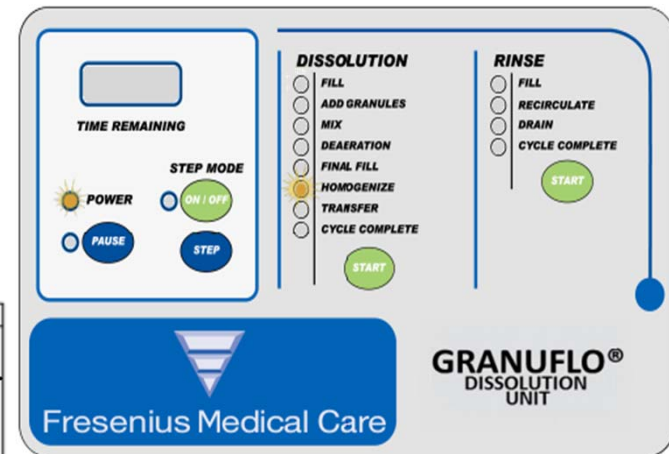
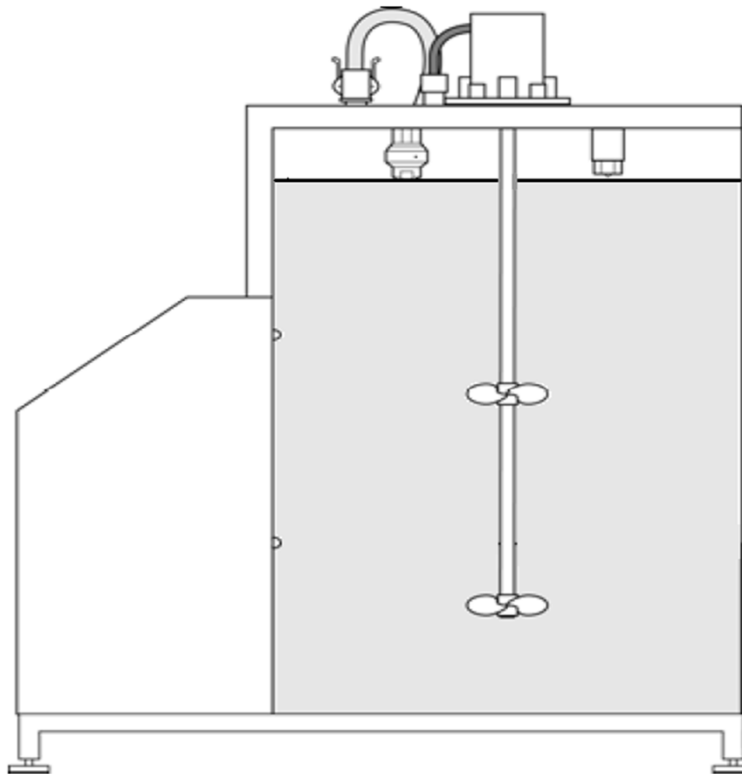

- **HOMOGENIZE Operation**
- **During this ten (10) minute Operation, the Mixer Motor stirs the solution.**
- **At the end of this Operation, the unit will automatically advance to TRANSFER Operation.**

# Dissolution Cycle (Mix Process – Step#3)

Example 132 - Gal

## TRANSFER Operation

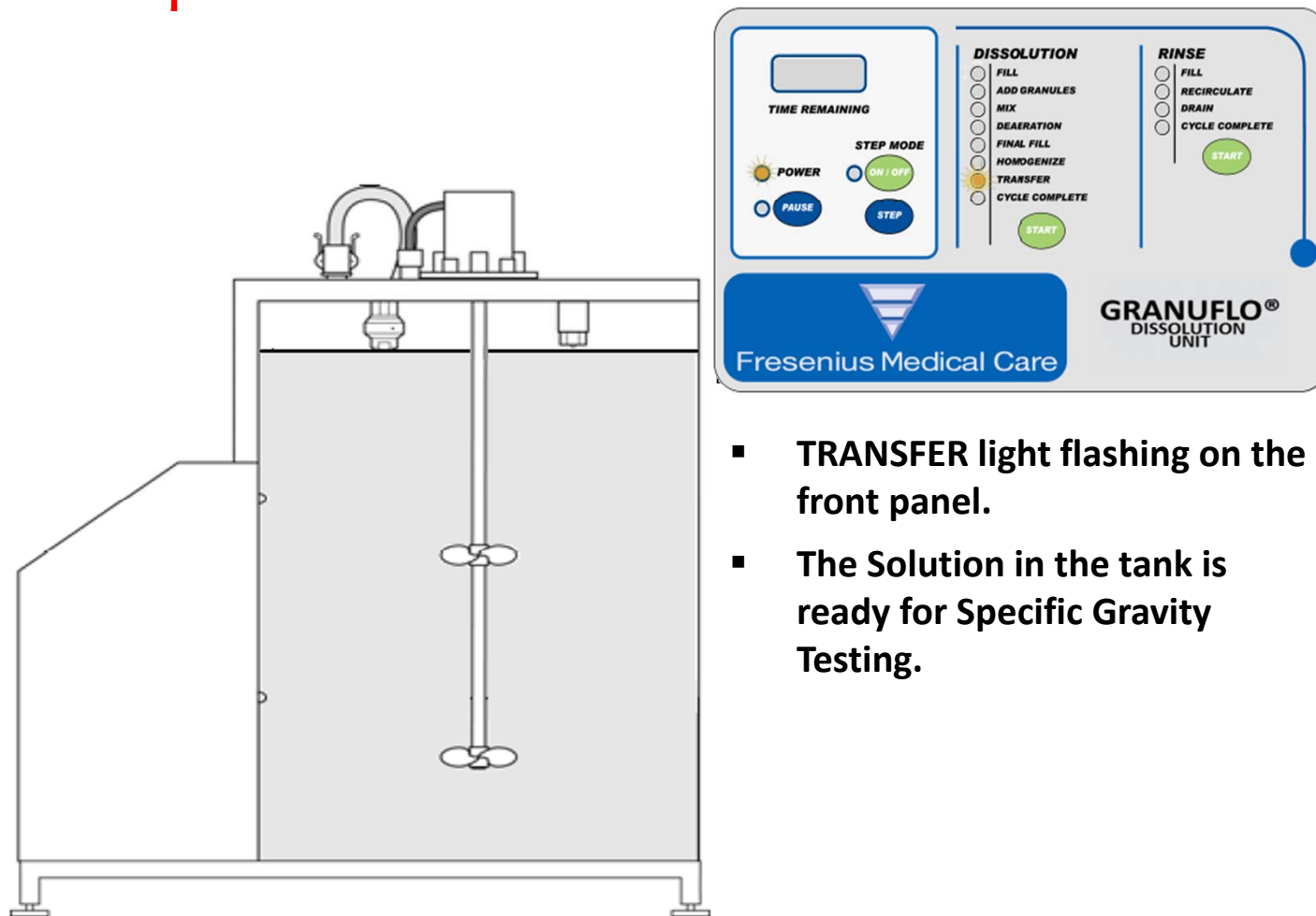

- TRANSFER light flashing on the front panel.
- The Solution in the tank is ready for Specific Gravity Testing.

# SPECIFIC GRAVITY TEST

**Operators Manual:**  
Section 7.1

# Specific Gravity Test

## Operators Manual Section 7.1

Once the Transfer Indicator light flashes, the concentrate is ready to be tested. This test is done using a hydrometer which measures the density of the acid in the concentrate. The resultant value is called the "specific gravity". The specific gravity is measured to verify that the concentrate has been properly mixed.

### Requirements for the test:

- Hydrometer
- Hydrometer Cylinder
- Thermometer\*
- Bucket/Container (approx. 3.5 gal)
- pHoenix Meter (EMD pH-indicator strips, Cat. #9590 or equivalent)

\*Minimum Requirements:  $25^{\circ}\text{C} \pm 5^{\circ}\text{C}$  ( $68^{\circ}$  to  $86^{\circ}\text{F}$ ) and accuracy  $\pm 1^{\circ}\text{C}$  ( $3.6^{\circ}\text{F}$ )

# Specific Gravity Test

## Operators Manual Section 7.1

1. Prepare the Hydrometer and the Hydrometer Cylinder.
  - Check Hydrometer for cracks.
  - Do not use a cracked Hydrometer.
  - Always handle the Hydrometer with care. Always hold it vertically by the top, as finger marks lower down can affect the accuracy of the instrument.
  - The Hydrometer should never be held by the stem horizontally.
  - Rinse the hydrometer and the hydrometer cylinder separately with purified water before checking solution for correct density. The purified water source must meet ANSI/AAMI or ISO standards for dialysis currently ANSI/AAMI RD62, or ISO 13959.
  - Once Hydrometer is clean, place the hydrometer onto a clean area.
  - The Hydrometer is fragile and can break easily.
  - Store in a Safe Area.

# Specific Gravity Test

## Operators Manual Section 7.1

2. Remove Transfer Line from the Transfer Hose Holder and connect the Transfer Line to the Transfer Nozzle.

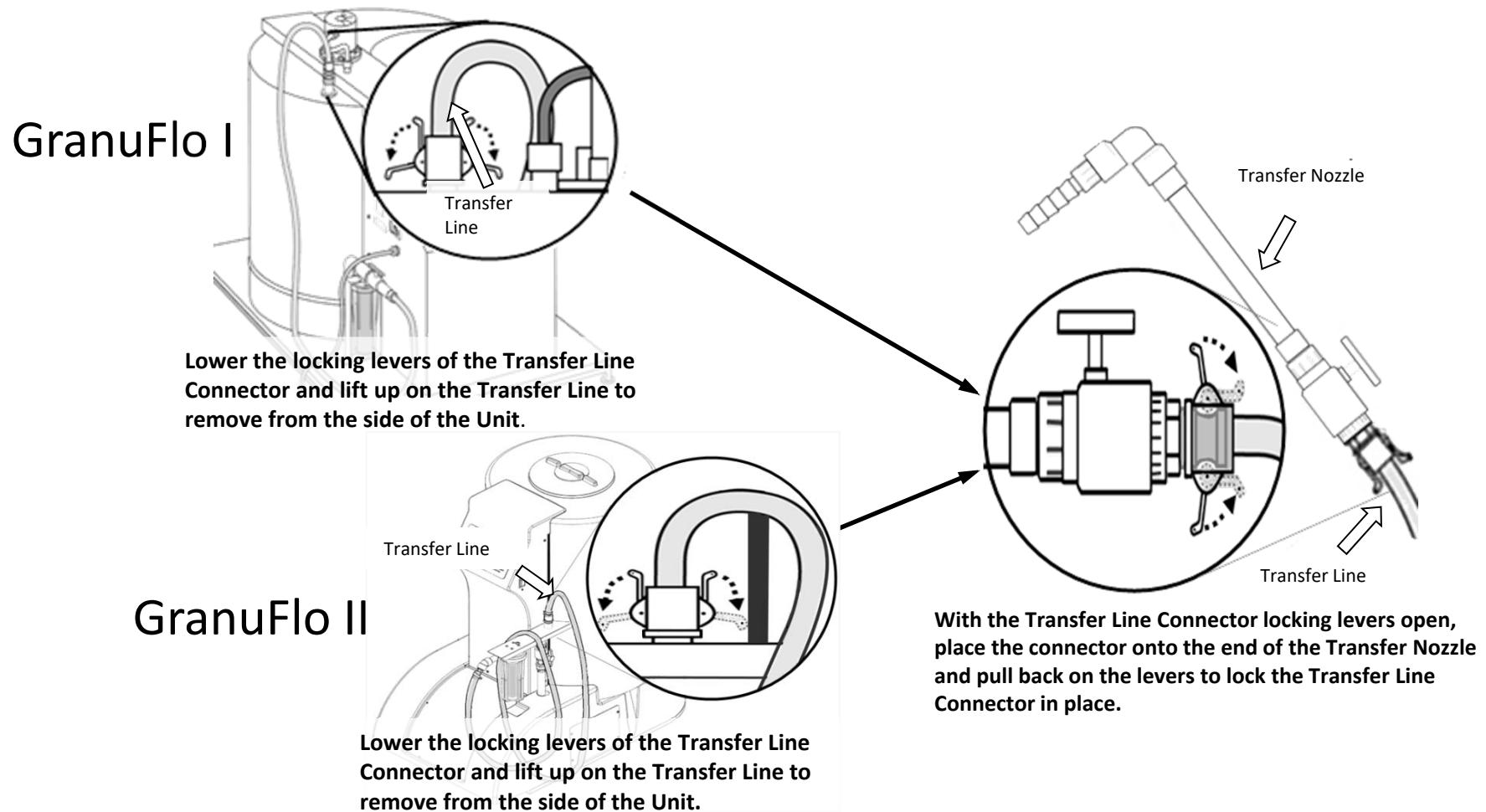

# Specific Gravity Test

## Operators Manual Section 7.1

3. Hold the Transfer Nozzle and make sure the Ball Valve on the Transfer Nozzle is CLOSED.
4. Slightly OPEN the Ball Valve next to the Filter Housing.
5. Press Dissolution START button and open slightly the Transfer Nozzle Ball Valve flush approximately 3.5 gallons of solution using a **container(s) that will allow for a 3.5 gallon measurement.**
  - This removes any solution left in the Transfer Line from a prior batch.
  - Once the 3.5 gallons of solution have been flushed out of the transfer hose, CLOSE the Transfer Nozzle Ball Valve.

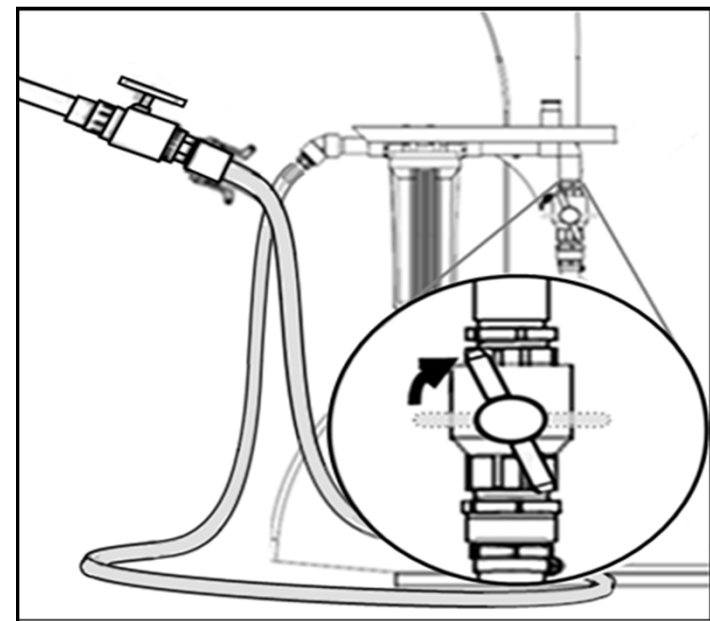
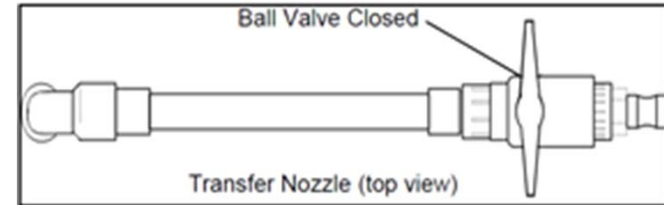

# Specific Gravity Test

## Operators Manual Section 7.1

### 6. Fill the Hydrometer Cylinder:

- Insert the Transfer Nozzle into the Hydrometer Cylinder.
- Slowly OPEN the Transfer Nozzle Valve until solution starts to slowly accumulate into the Hydrometer Cylinder. Allowing solution to fill down the side of the beaker minimizes the creation of bubbles within the solution (see figure item A).
- Fill the Hydrometer Cylinder approximately 2/3rd full.
- Close Transfer Nozzle and the Ball Valve next to the filter housing, then press PAUSE on the Display Panel.
- Place Transfer Nozzle onto a clean surface.

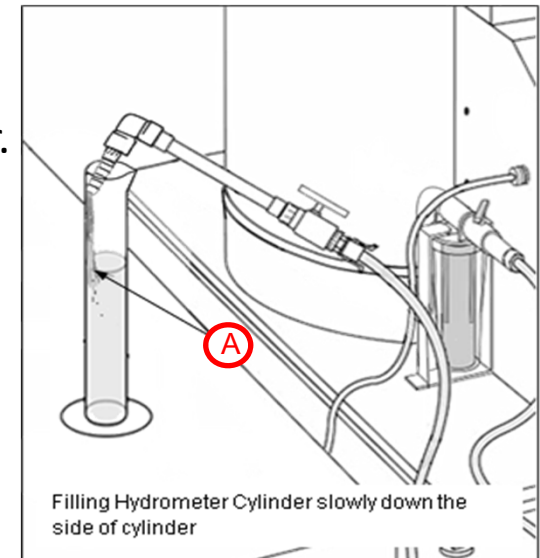

- ### 7. Make sure the solution does not have excessive amount of bubbles. To release excess amount of bubbles from the solution gently tap the Hydrometer Cylinder or gently swirl. (See Adjacent Picture).

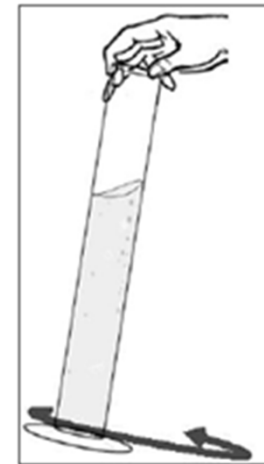



# Specific Gravity Test

## Operators Manual Section 7.1

### 8. Place Hydrometer Cylinder on a level table

- Measure the temperature of the solution in the Hydrometer and record it on the batch production record form.
- For thermometer requirements refer to appendix A or B.

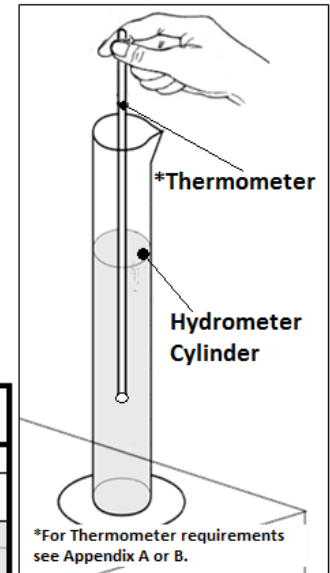

### CITRASATE DRY BATCH PRODUCTION FORM

Dialysis Unit Name & Location #:		Dry Acid Dissolution Unit Serial #:	
DRY ACID PRODUCT CASE INFORMATION			
OPERATOR (print name):	DATE:	TIME:	Batch #:
CASE 1: Dry Acid Catalog # (label on box)	BOX Lot #	4 <sup>TH</sup> bag used ✓ box Yes <input type="checkbox"/>	Potassium # (1K, 2K, 3K)
CASE 2: Dry Acid Catalog #	BOX Lot #	4 <sup>TH</sup> bag used ✓ box Yes <input type="checkbox"/>	Potassium #
CASE 3: Dry Acid Catalog #	BOX Lot #	4 <sup>TH</sup> bag used ✓ box Yes <input type="checkbox"/>	Potassium #
CASE 4: Dry Acid Catalog #	BOX Lot #	4 <sup>TH</sup> bag used ✓ box Yes <input type="checkbox"/>	Potassium #
CASE 5: Dry Acid Catalog #	BOX Lot #	4 <sup>TH</sup> bag used ✓ box Yes <input type="checkbox"/>	Potassium #
CASE 6: Dry Acid Catalog #	BOX Lot #	4 <sup>TH</sup> bag used ✓ box Yes <input type="checkbox"/>	Potassium #
1. After Final Fill Level has been reached, turned OFF water valve to the Unit. Once this is done check the box			<input type="checkbox"/>
SPECIFIC GRAVITY			
Measured Temp TEMP:	Print Catalog # - Specific Gravity Value for the Measured Temp listed in Appendix A: LOW:	HIGH:	Measured Specific Gravity Value: Check one <input type="checkbox"/> Pass <input type="checkbox"/> Fail (void section)
OPERATOR SIGNATURE:		VERIFIER SIGNATURE:	

# Specific Gravity Test

## Operators Manual Section 7.1

### 9. On Appendix A or B

- Locate the Catalog number of the dry acid product being used (1)
- Locate the value of the “measured temperature” of the solution (2)
- Moving across and then down, identify the ‘low’ and ‘high’ specific gravity numbers.
- These ‘low’ and ‘high’ numbers can be recorded in the appropriate box in the Batch Production Record Form located at the last pages on the manual (3).

APPENDIX B: CITRASATE® DRY SPECIFIC GRAVITIES TABLE

### Specific Gravity Ranges

1:44 PROPORTIONING

		17°C to 21°C		22°C to 26°C		27°C to 31°C	
Catalog Number		Low	High	Low	High	Low	High
1K	OFD1231-DA	1.191	1.203	1.189	1.201	1.187	1.199
	OFD1251-DA	1.192	1.204	1.189	1.201	1.187	1.199
2K	OFD2231-DA	1.193	1.205	1.191	1.203	1.189	1.201
	OFD2251-DA	1.193	1.205	1.191	1.203	1.189	1.201
	OFD2301-DA	1.194	1.206	1.192	1.204	1.190	1.202
3K	OFD3231-DA	1.195	1.207	1.193	1.205	1.191	1.203
	OFD3251-DA	1.195	1.207	1.193	1.205	1.191	1.203
	OFD3301-DA	1.196	1.208	1.194	1.206	1.192	1.204

Minimum Thermometer Specifications: Temperature Range 25° C +/-5°C (68° to 86° F) and accuracy +/- 1°C (3.6 °F)

### CITRASATE DRY BATCH PRODUCTION FORM

Dialysis Unit Name & Location #:		Dry Acid Dissolution Unit Serial #:	
DRY ACID PRODUCT CASE INFORMATION			
OPERATOR (print name):	DATE:	TIME:	Batch #:
CASE 1: Dry Acid Catalog # (label on box)	BOX Lot #	4 <sup>th</sup> bag used ✓ box yes <input type="checkbox"/>	Potassium # (1K, 2K, 3K)
CASE 2: Dry Acid Catalog #	BOX Lot #	4 <sup>th</sup> bag used ✓ box yes <input type="checkbox"/>	Potassium #
CASE 3: Dry Acid Catalog #	BOX Lot #	4 <sup>th</sup> bag used ✓ box yes <input type="checkbox"/>	Potassium #
CASE 4: Dry Acid Catalog #	BOX Lot #	4 <sup>th</sup> bag used ✓ box yes <input type="checkbox"/>	Potassium #
CASE 5: Dry Acid Catalog #	BOX Lot #	4 <sup>th</sup> bag used ✓ box yes <input type="checkbox"/>	Potassium #
CASE 6: Dry Acid Catalog #	BOX Lot #	4 <sup>th</sup> bag used ✓ box yes <input type="checkbox"/>	Potassium #
1. After Final Fill Level has been reached, turned OFF water valve to the unit. Once this is done check the box <input type="checkbox"/>			
SPECIFIC GRAVITY			
Measured Temp TEMP:	Print Catalog # Specific Gravity Value for the Measured Temp listed in Appendix A: LOW:	Measured Specific Gravity Value: HIGH:	Check one <input type="checkbox"/> Pass <input type="checkbox"/> Fail (void section)
OPERATOR SIGNATURE:		VERIFIER SIGNATURE:	

# Specific Gravity Test

## Operators Manual Section 7.1

10. Obtain the clean hydrometer and slowly lower the hydrometer into the solution until the hydrometer begins to float freely.
11. Hold the top of the hydrometer between your thumb and finger and spin the hydrometer in the Hydrometer Cylinder.
  - The slow spinning action of the hydrometer will cause the hydrometer to stay away from the sides of the Hydrometer Cylinder.
  - In addition, this will help keep bubbles from forming on the hydrometer.

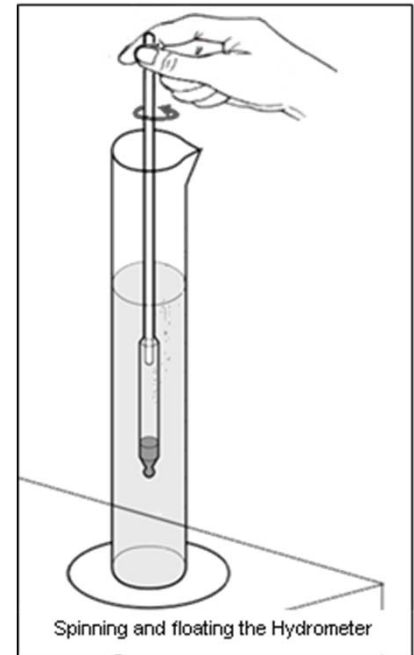

# Specific Gravity Test

## Operators Manual Section 7.1

### 12. Hydrometer will move up and down

- If during the up and down movement of the hydrometer the meniscus is crinkled or dragged out of shape by the motion of the hydrometer, then this indicates that either the hydrometer or the surface of the solution is not clean. Clean the hydrometer and Hydrometer Cylinder again. Then restart the Specific Gravity from step 1.
- If the meniscus remains unchanged as the hydrometer rise and falls, then the hydrometer and liquid surface are clean and a reading can be taken.

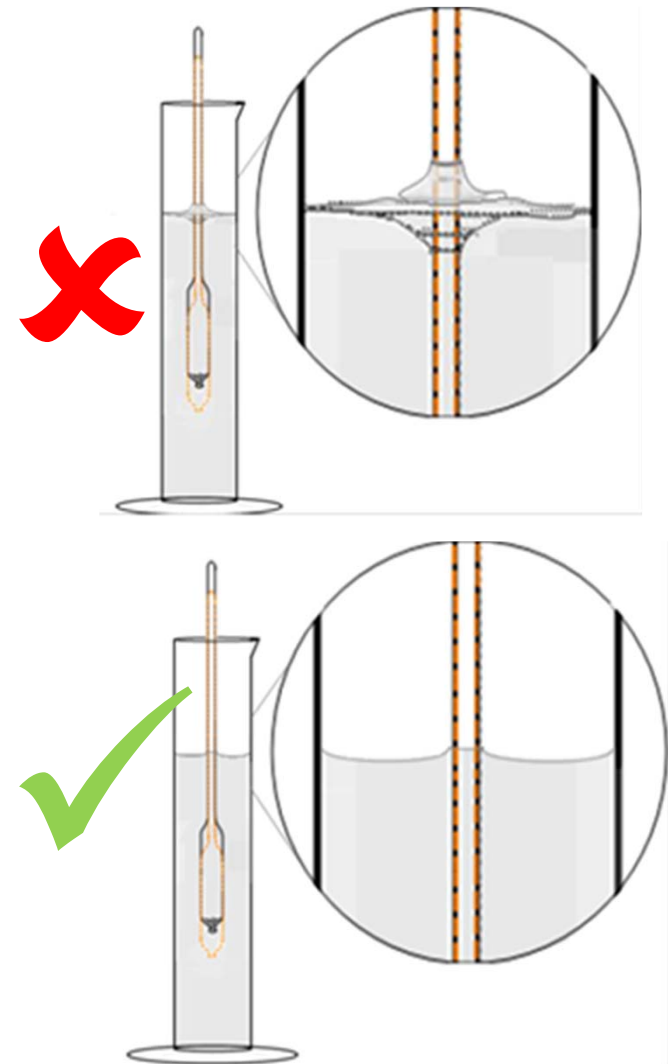

# Specific Gravity Test

## Operators Manual Section 7.1

13. Allow the hydrometer to settle within the solution. Once the hydrometer is stable, place your head at eye level to the meniscus of the solution as seen in the adjacent Figure.

- The point where the bottom of the meniscus crosses the hydrometer is the correct measuring point.
- Do not take a reading if the hydrometer is touching the side of the hydrometer cylinder.

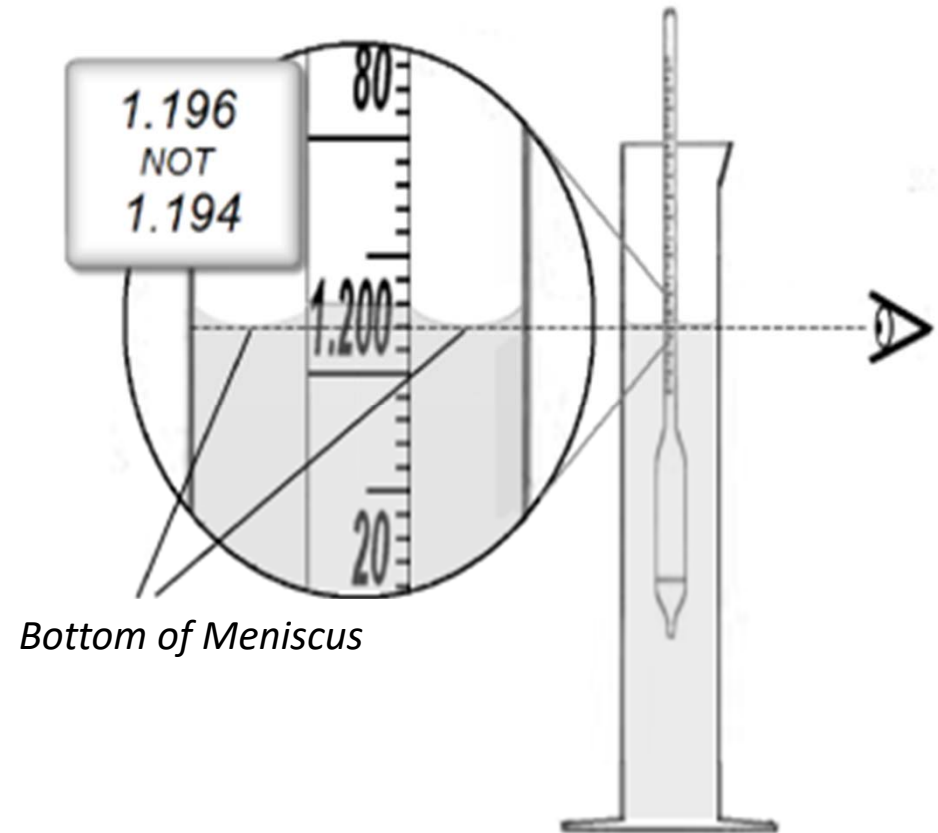

# How to read the Hydrometer

(SCALE)

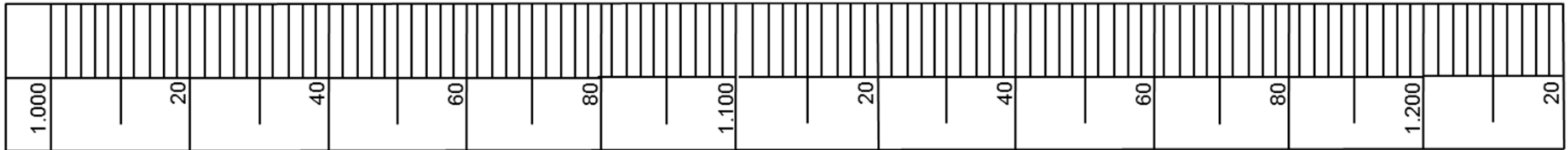

FULL SCALE



# How to read the Hydrometer

## (SCALE)

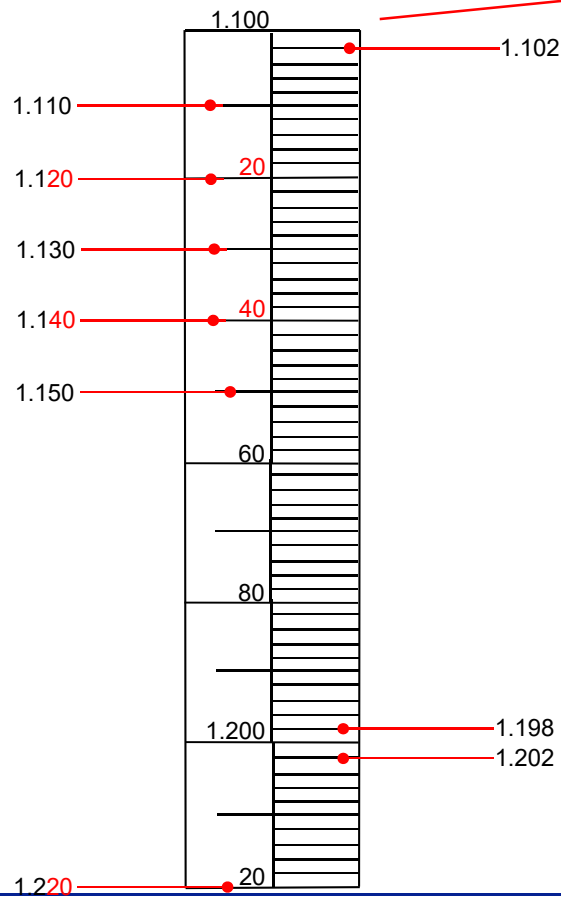
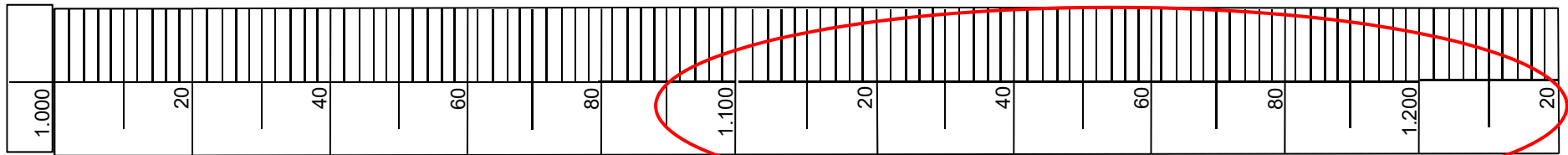

### Notes

- Every line in the scale represents a value of .002.

# Specific Gravity Test

## Operators Manual Section 7.1

- Document the Specific Gravity in the Batch Production Record Form in the "Measured Specific Gravity Value" box.

FORM 2: CITRASATE® DRY WITH ACETATE PRODUCTION RECORD

DIALYSIS UNIT NAME & LOCATION #:		GranuFlo I Dissolution Unit Serial #:	
<b>DRY ACID PRODUCT CASE INFORMATION</b>			
OPERATOR ( <i>print name</i> ):	DATE:	TIME:	Batch #:
CASE 1: Dry Acid Catalog # (label on box)	BOX Lot #	4 <sup>th</sup> bag used ✓ box Yes <input type="checkbox"/>	Potassium # (1K, 2K, 3K)
CASE 2: Dry Acid Catalog #	BOX Lot #	4 <sup>th</sup> bag used ✓ box Yes <input type="checkbox"/>	Potassium #
CASE 3: Dry Acid Catalog #	BOX Lot #	4 <sup>th</sup> bag used ✓ box Yes <input type="checkbox"/>	Potassium #
CASE 4: Dry Acid Catalog #	BOX Lot #	4 <sup>th</sup> bag used ✓ box Yes <input type="checkbox"/>	Potassium #
CASE 5: Dry Acid Catalog #	BOX Lot #	4 <sup>th</sup> bag used ✓ box Yes <input type="checkbox"/>	Potassium #
CASE 6: Dry Acid Catalog #	BOX Lot #	4 <sup>th</sup> bag used ✓ box Yes <input type="checkbox"/>	Potassium #
CASE 7: Dry Acid Catalog #	BOX Lot #	4 <sup>th</sup> bag used ✓ box Yes <input type="checkbox"/>	Potassium #
CASE 8: Dry Acid Catalog #	BOX Lot #	4 <sup>th</sup> bag used ✓ box Yes <input type="checkbox"/>	Potassium #
<b>SPECIFIC GRAVITY</b>			
Measured Temp	Print Catalog # -Specific Gravity Value for the Measured Temp listed in Appendix A:		Measured Specific Gravity Value: <input type="text"/>
TEMP:	LOW:	HIGH:	
			Check one <input type="checkbox"/> -Pass <input type="checkbox"/> -Fail (void section)
1. After Final Fill Level has been reached, CLOSE water supply valve to the Unit. Once this is done check the box <input type="checkbox"/>			
OPERATOR SIGNATURE:		VERIFIER SIGNATURE:	



# Specific Gravity Test

## Operators Manual Section 7.1

15. If the results from the Specific Gravity Test are **acceptable** (Measured Value within Low and High Values), check the “Pass” box onto the Citrasate Dry with Acetate Batch Production Record Form. The solution is ready for the **TRANSFER** operation

FORM 2: CITRASATE® DRY WITH ACETATE PRODUCTION RECORD

DIALYSIS UNIT NAME & LOCATION #:		GranuFlo I Dissolution Unit Serial #:	
<b>DRY ACID PRODUCT CASE INFORMATION</b>			
OPERATOR ( <i>print name</i> ):	DATE:	TIME:	Batch #:
CASE 1: Dry Acid Catalog # (label on box)	BOX Lot #	4 <sup>th</sup> bag used ✓ box Yes <input type="checkbox"/>	Potassium # (1K, 2K, 3K)
CASE 2: Dry Acid Catalog #	BOX Lot #	4 <sup>th</sup> bag used ✓ box Yes <input type="checkbox"/>	Potassium #
CASE 3: Dry Acid Catalog #	BOX Lot #	4 <sup>th</sup> bag used ✓ box Yes <input type="checkbox"/>	Potassium #
CASE 4: Dry Acid Catalog #	BOX Lot #	4 <sup>th</sup> bag used ✓ box Yes <input type="checkbox"/>	Potassium #
CASE 5: Dry Acid Catalog #	BOX Lot #	4 <sup>th</sup> bag used ✓ box Yes <input type="checkbox"/>	Potassium #
CASE 6: Dry Acid Catalog #	BOX Lot #	4 <sup>th</sup> bag used ✓ box Yes <input type="checkbox"/>	Potassium #
CASE 7: Dry Acid Catalog #	BOX Lot #	4 <sup>th</sup> bag used ✓ box Yes <input type="checkbox"/>	Potassium #
CASE 8: Dry Acid Catalog #	BOX Lot #	4 <sup>th</sup> bag used ✓ box Yes <input type="checkbox"/>	Potassium #
<b>SPECIFIC GRAVITY</b>			
Measured Temp	Print Catalog # -Specific Gravity Value for the Measured Temp listed in Appendix A:		Measured Specific Gravity Value:
TEMP:	LOW:	HIGH:	Check one <input type="checkbox"/> -Pass <input type="checkbox"/> -Fail (void section)
1. After Final Fill Level has been reached, CLOSE water supply valve to the Unit. Once this is done check the box			<input type="checkbox"/>
OPERATOR SIGNATURE:		VERIFIER SIGNATURE:	

# Specific Gravity Test

## Operators Manual Section 7.1

16. Pour residual solution from hydrometer cylinder into the solution present in the **residual solution bucket** .

Rinse the hydrometer cylinder and the hydrometer before storing equipment. To dispose the solution in the Residual Solution Bucket, See Section 13.1: Residual Solution Bucket Disposal of the Operators Manual.

# Practice Exercise

**General Instructions:** Read carefully and follow the instructions for this exercise provided on the bottom of this page.

The Operator “X” from the Dialysis Unit “FMCNA #13” located in “Dallas, TX.” is preparing to make his first batch of Citrasate Dry Product Code 0FD1231-DA using a 99 Gallon Dry Acid Dissolution Unit (mixer) with the serial number DA99-123456. The user has several cases of the product with the label shown on the next slide.

Each case of Citrasate Dry contains 4 bags.

It is November 12, 2011 and the time is 9:25 am and the user starts with the mixing process. After mixing, the operator proceeds to test for Specific Gravity.

The results are shown below:

Temperature of Sample: 27° C, Specific Gravity: 1.198

**Instructions:** Using the information provided above and the label shown in the next slide, fill in the batch production record attached to the manual.

# Practice Exercise

1.0K

WARNING: NOT FOR PARENTERAL USE. Use of this Acid Concentrate without the associated bicarbonate concentrate may cause patient injury or death.

2.25 Ca

45X

CITRASATE® DRY

62.5 LITER MIX (16.5 GAL)

Dry Acid Concentrate for Bicarbonate Dialysis

0FD1231-DA

NON-PYROGENIC

Ionic Contribution of Acid Concentrate: (Nominal Dilution 1:44)		Chemical Composition Total Acid Concentrate (in kg) (Pre-Dilution)	
<b>SODIUM</b>	100.3 mEq/L	<b>NaCl</b>	16.4 kg
<b>POTASSIUM</b>	1.0 mEq/L	<b>KCl</b>	0.210 kg
<b>CALCIUM</b>	2.25 mEq/L	<b>CaCl<sub>2</sub>·2H<sub>2</sub>O</b>	0.465 kg
<b>MAGNESIUM</b>	1.0 mEq/L	<b>MgCl<sub>2</sub>·6H<sub>2</sub>O</b>	0.286 kg
<b>ACETATE</b>	0.3 mEq/L	<b>C<sub>2</sub>H<sub>3</sub>NaO<sub>2</sub>·3H<sub>2</sub>O</b>	0.085 kg
<b>CITRATE</b>	2.4 mEq/L	<b>C<sub>6</sub>H<sub>8</sub>O<sub>7</sub></b>	0.432 kg
<b>CHLORIDE</b>	104.3 mEq/L	<b>C<sub>6</sub>H<sub>12</sub>O<sub>6</sub>·H<sub>2</sub>O</b>	3.09 kg
<b>DEXTRROSE</b>	100 mg/dL	<b>Total Wt: 21.0 kg</b>	

DESCRIPTION FOR USE: For use with FMCNA 45X sodium bicarbonate with a three-stream hemodialysis machine set for 45X (1 part acid concentrate is mixed with 1.72 parts of bicarbonate concentrate and 42.28 parts of purified water) resulting in final dialysate containing sodium 137 mEq/L, and bicarbonate 34.6 mEq/L. The final dialysate total buffer is 37.3 mEq/L (34.6 mEq/L bicarbonate + 2.4 mEq/L citrate + 0.3 mEq/L acetate). This package configuration is designed to be mixed using an FMCNA Dry Acid Dissolution Unit. All other constituents remain as listed in the Ionic Contribution of Acid Concentrate table.

**CAUTION:** Refer to instructions provided by the hemodialysis machine manufacturer. Check conductivity and pH of final dialysate just prior to dialysis treatment and each time new concentrate is supplied to the machine. Refer to manufacturer for nominal conductivity of final dialysate. Use only as directed. Federal law (USA) restricts this device to sale by or on order of a physician. DO NOT USE IF PACKAGE IS OPEN OR DAMAGED.

**WARNING:** Acetate and Citrate constituents contribute to the Total Buffer, which is in addition to the prescribed bicarbonate. Over-prescribing bicarbonate and the resulting total buffer (Bicarbonate + acetate + citrate) can lead to alkalosis in the patient, a significant risk factor associated with cardiopulmonary arrest. Underprescribing bicarbonate and Total Buffer can lead to acidosis, a significant risk factor associated with bone loss and an increased risk of death.

**INSTRUCTIONS FOR DISSOLUTION**

The contents may clump or harden which does not affect product chemical composition. When fully dissolved, six (6) cases produce 375 liters (99 gals); Eight (8) cases make 500 liters (132 gals). Refer to FMCNA Dry Acid Dissolution Unit Operator's manual for additional details.

- 1) Use only with water that meets or exceeds current ANSI/AAMI RD62 or ISO 13959 hemodialysis water quality standards. Water temperature should be 20° - 30° C for proper dissolution.
- 2) Perform a Rinse Cycle before starting the batch by pressing the Rinse Start button. Wait for cycle to complete before continuing.
- 3) Begin the batch by pressing the Dissolution Start button. Wait until ADD GRANULES light begins to flash
- 4) Add Dry Acid to Dissolution Unit. Verify all cases are the same catalog #, formulation and lot #.

**IMPORTANT:** Use entire contents of each bag (4) within this case. Do not use unless all (4) bags are present. The contents of the bags are different. All bags must be used. Label tank with contents and date prepared.

- 5) Continue with mixing procedure according to the FMCNA Dry Acid Dissolution Unit Operator's manual.
- 6) When mixing is complete, test for proper Specific Gravity according to the FMCNA Dry Acid Dissolution Unit Operator's manual. Filter with a nominal 1 micron filter during transfer. Keep container sealed. Label and date all storage containers.

**AVOID EXCESSIVE TEMPERATURE. STORE IN A DRY LOCATION.**

Manufactured for:  
Advanced Renal Technologies  
Bellevue, WA 98005  
Citraset® is a registered trademark of Advanced Renal Technologies.  
U.S. patent 6,610,206 and others applied for.

**MANUFACTURER/DISTRIBUTOR:**  
Fresenius Medical Care NA  
Waltham, MA 02451  
1-800-222-5188

ART Formula Code:

DRY-5501-16.5

Exp. Date JAN 2013  
Lot # 12ATGF009

FMCNA Cat. No. 0FD1231-DA

# Practice Exercise

## PRACTICE EXERCISE RECORD FORM

### FORM 2: CITRASATE® DRY WITH ACETATE PRODUCTION RECORD

Dialysis Unit Name & Location #: <b>FMCNA #13. Dallas, Tx.</b>		Dry Acid Dissolution Unit Serial #: <b>DA99-123456.</b>	
<b>DRY ACID PRODUCT CASE INFORMATION</b>			
OPERATOR (print name): <b>Operator X</b>	DATE: <b>11/12/2011</b>	TIME: <b>9:25 a.m.</b>	Batch #: <b>1</b>
CASE 1: Dry Acid Catalog# (label on box) <b>0FD1231-DA</b>	BOX Lot # <b>Lot# 12ATGF009</b>	4 <sup>TH</sup> bag used ✓ box Yes <input checked="" type="checkbox"/>	Potassium # (1k, 2k, 3k) <b>1K</b>
CASE 2: Dry Acid Catalog# <b>0FD1231-DA</b>	BOX Lot # <b>Lot# 12ATGF009</b>	4 <sup>TH</sup> bag used ✓ box Yes <input checked="" type="checkbox"/>	Potassium # <b>1K</b>
CASE 3: Dry Acid Catalog# <b>0FD1231-DA</b>	BOX Lot # <b>Lot# 12ATGF009</b>	4 <sup>TH</sup> bag used ✓ box Yes <input checked="" type="checkbox"/>	Potassium # <b>1K</b>
CASE 4: Dry Acid Catalog# <b>0FD1231-DA</b>	BOX Lot # <b>Lot# 12ATGF009</b>	4 <sup>TH</sup> bag used ✓ box Yes <input checked="" type="checkbox"/>	Potassium # <b>1K</b>
CASE 5: Dry Acid Catalog# <b>0FD1231-DA</b>	BOX Lot # <b>Lot# 12ATGF009</b>	4 <sup>TH</sup> bag used ✓ box Yes <input checked="" type="checkbox"/>	Potassium # <b>1K</b>
CASE 6: Dry Acid Catalog# <b>0FD1231-DA</b>	BOX Lot # <b>Lot# 12ATGF009</b>	4 <sup>TH</sup> bag used ✓ box Yes <input checked="" type="checkbox"/>	Potassium # <b>1K</b>
1. After Final Fill Level has been reached, turned OFF water valve to the Unit. Once this is done check the box			<input checked="" type="checkbox"/>
<b>SPECIFIC GRAVITY</b>			
Measured Temp	Print Catalog #-Specific Gravity Value for the Measured Temp listed in Appendix A:		Measured Specific Gravity Value:
TEMP: <b>27° C</b>	LOW: <b>1.187</b>	HIGH: <b>1.199</b>	<b>1.198</b>
			Check one <input checked="" type="checkbox"/> -Pass <input type="checkbox"/> -Fail (void section)
OPERATOR SIGNATURE: <b>Operator X</b>		VERIFIER SIGNATURE: <b>Verifier Y</b>	

# Practice Exercise

## APPENDIX B: CITRASATE® DRY SPECIFIC GRAVITIES TABLE

### Specific Gravity Ranges

1:44 PROPORTIONING

		17°C to 21°C		22°C to 26°C		27°C to 31°C	
Catalog Number		Low	High	Low	High	Low	High
1K	0FD1231-DA	1.191	1.203	1.189	1.201	1.187	1.199
	0FD1251-DA	1.192	1.204	1.189	1.201	1.187	1.199
2K	0FD2231-DA	1.193	1.205	1.191	1.203	1.189	1.201
	0FD2251-DA	1.193	1.205	1.191	1.203	1.189	1.201
	0FD2301-DA	1.194	1.206	1.192	1.204	1.190	1.202
3K	0FD3231-DA	1.195	1.207	1.193	1.205	1.190	1.202
	0FD3251-DA	1.195	1.207	1.193	1.205	1.191	1.203
	0FD3301-DA	1.196	1.208	1.194	1.206	1.192	1.204

Minimum Thermometer Specifications: Temperature Range 25° C +/-5°C (68° to 86° F) and accuracy +/- 1°C (3.6 °F)

What thermometer to use?

# TRANSFER

## Step # 4

**Operators Manual:**  
Section 7.2, 7.3

# Transfer (Mix Process – Step #4)

Operators Manual Section 7.2 and 7.3

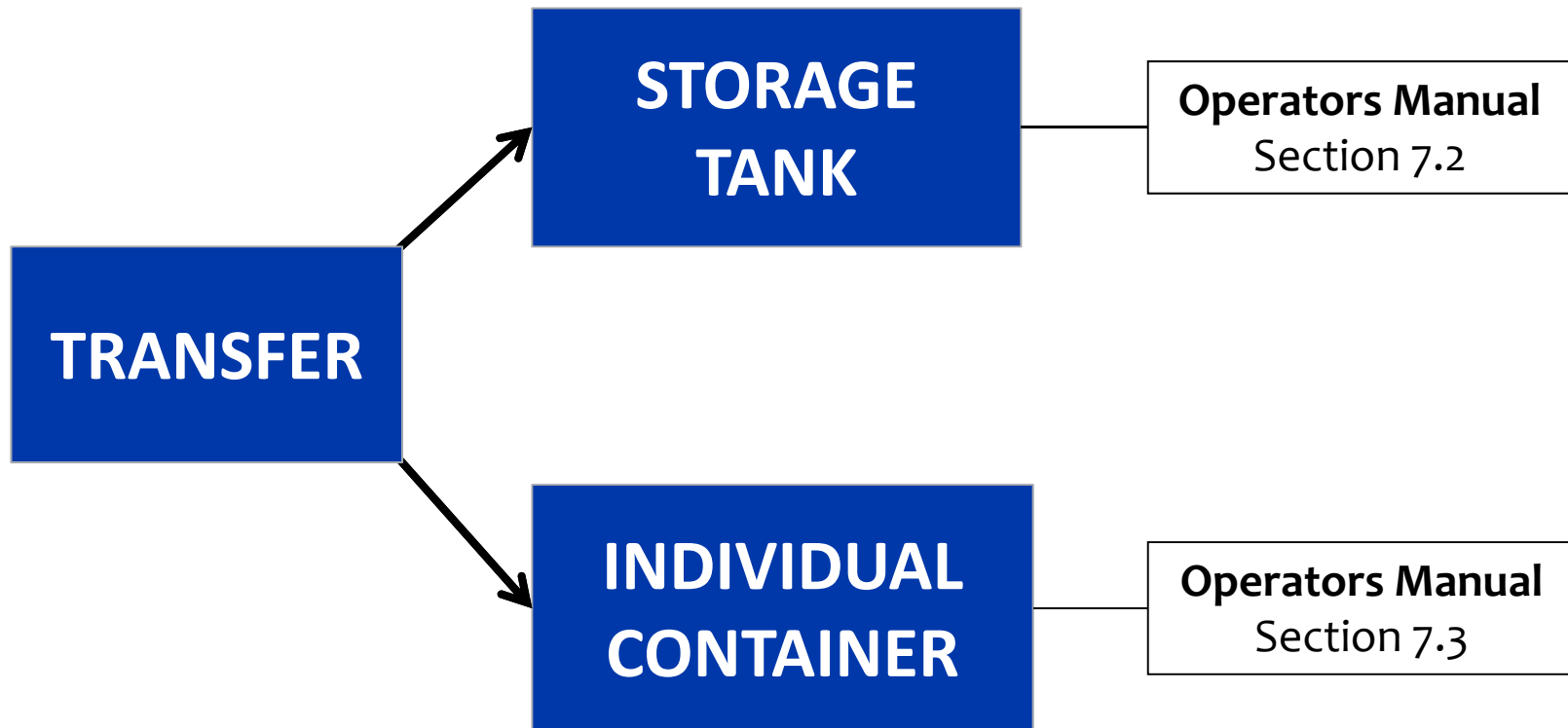



# Transfer (Mix Process – Step #4)

Operators Manual Section 7.2 and 7.3

## TRANSFER TO STORAGE TANK (SECTION 7.2, STEPS 1 TO 3)

- After you have obtained a valid specific gravity reading, remove the Transfer Line from the Transfer Nozzle.
- 1st Connect Transfer Line to the storage tank, 2nd open ball valve at the side of the Filter Housing. 3rd Press the Dissolution START button to transfer concentrate into the storage tank.
- Once Transfer of solution is complete, place Transfer line on to the Dissolution Unit Transfer Line Holder. Do not leave Transfer line attached to the Storage Tank.

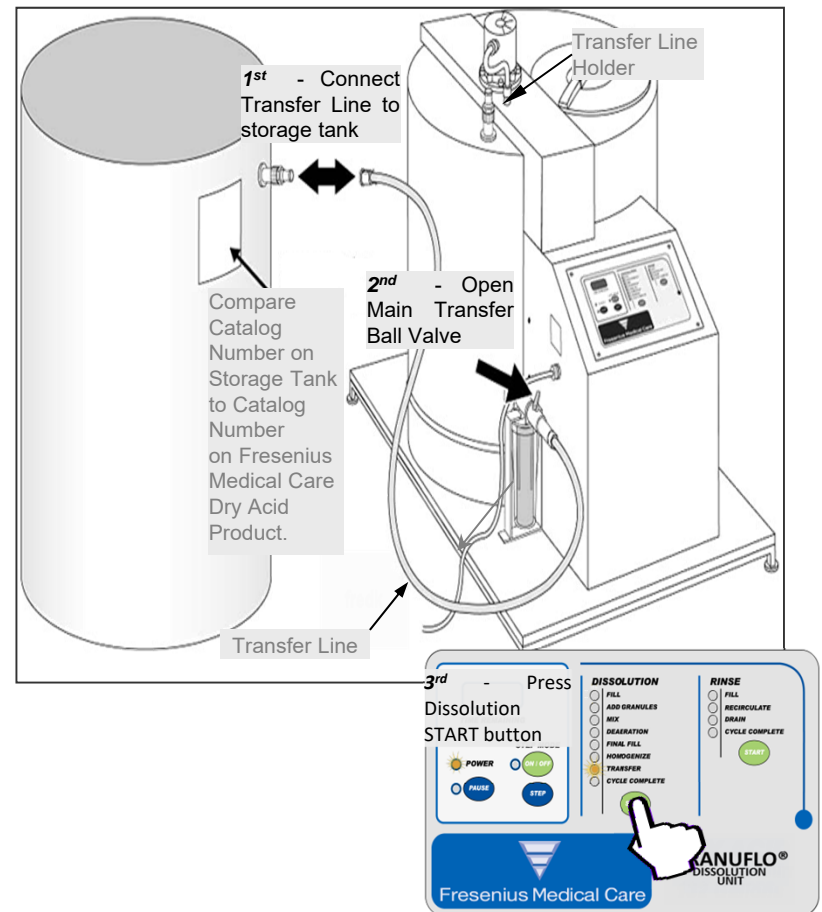

# Transfer (Mix Process – Step #4)

Operators Manual Section 7.2 and 7.3

## TRANSFER TO INDIVIDUAL CONTAINER (SECTION 7.3)

- ❑ Containers must be properly labeled
- ❑ Connect the Transfer Line to the Transfer Nozzle. Place the Transfer Nozzle into the opening of an individual container
- ❑ Slightly OPEN the Ball Valve on the top of the Filter Housing.
- ❑ With the Transfer light flashing, Press Dissolution START button. The Transfer Pump will start.
- ❑ Slowly OPEN Ball Valve on the Transfer Nozzle until the desired rate of flow through the nozzle is achieved.

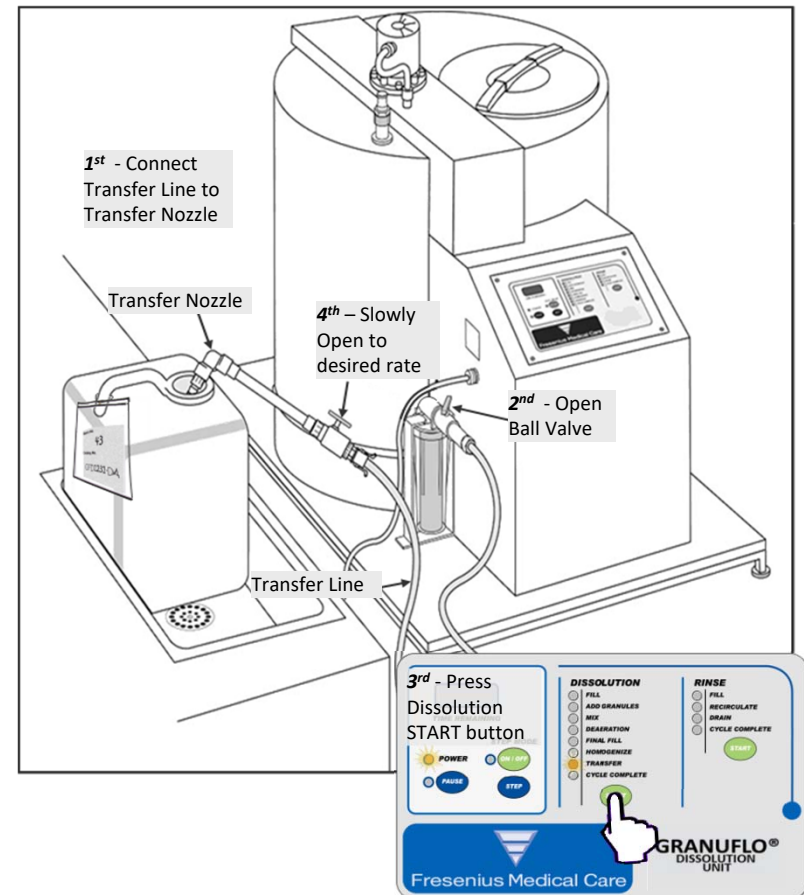

# Transfer (Mix Process – Step #4)

Operators Manual Section 7.2 and 7.3

## TRANSFER TO INDIVIDUAL CONTAINER (SECTION 7.3)

- Once the manual TRANSFER Operation has been completed and the individual containers are filled, CLOSE Transfer Nozzle Valve. Press the PAUSE button.
- When the GranuFlo Dissolution Unit is empty, the GranuFlo Dissolution Unit will step to the CYCLE COMPLETE Operation.

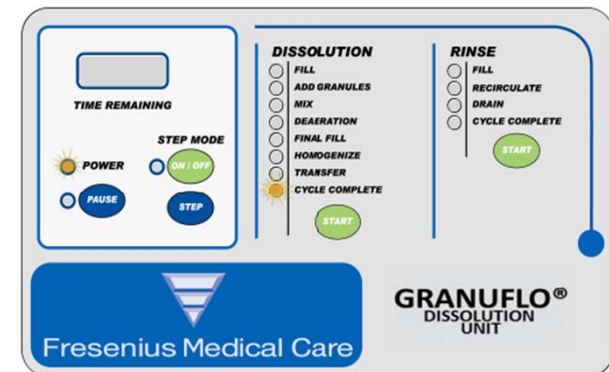
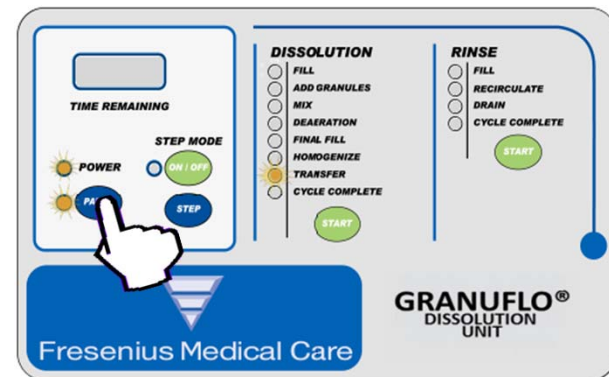

# Maintenance Program

## Operators Manual: Section 8.0

# Maintenance Overview

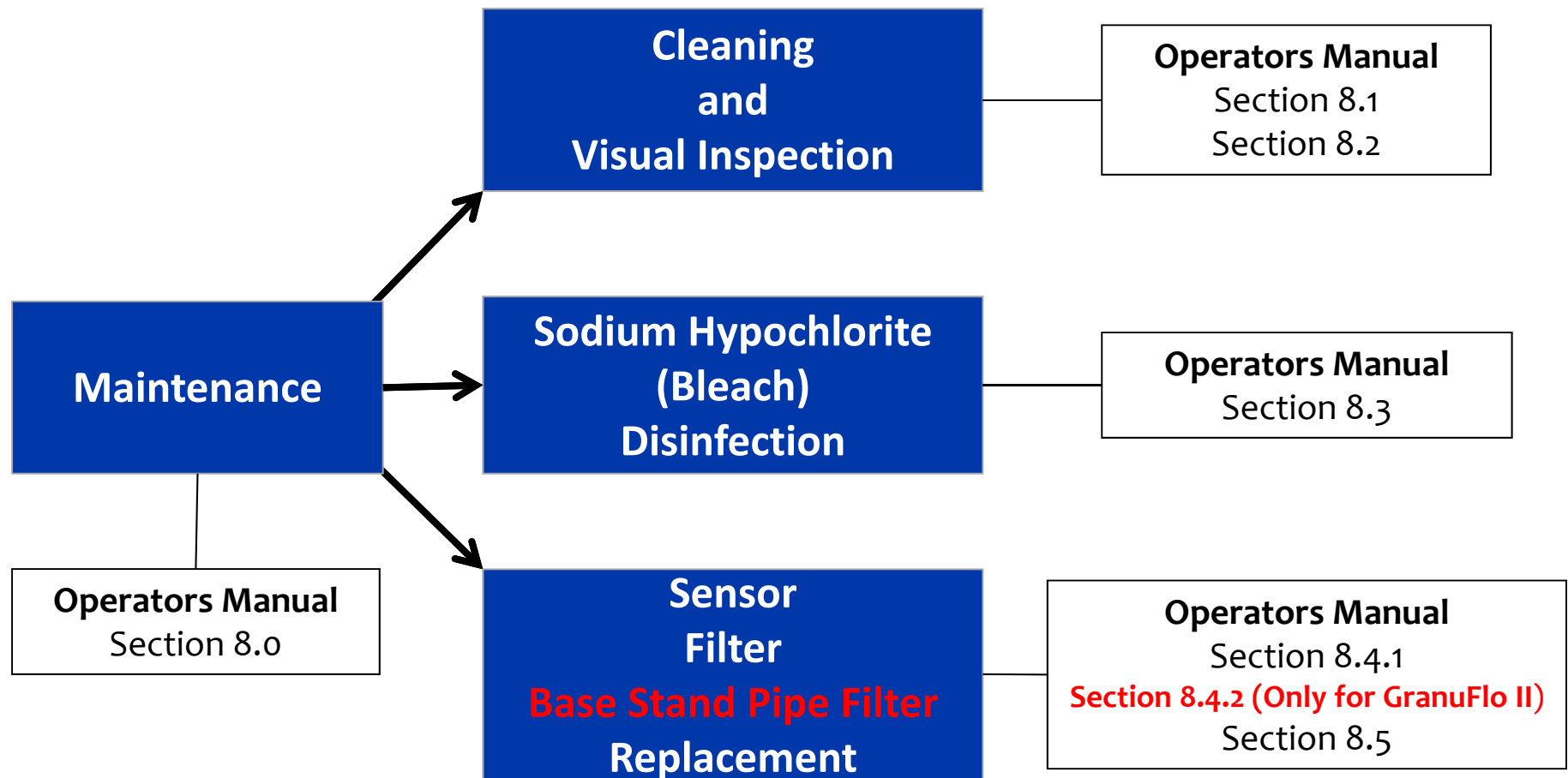

# Cleaning and Visual Inspection

**Operators Manual:**  
Section 8.1, 8.2

# Maintenance

## Cleaning and Visual Inspection

### **CLEANING**

Clean the exterior surface of the GranuFlo Dissolution Unit thoroughly after each batch of concentrate is mixed. If necessary, a mild detergent solution may be used to clean the exterior surface. Care should be taken not to contaminate the system interior. All spills should be wiped off immediately. Spillage at the control panel should be avoided in order to minimize the possibility of electrical malfunction

### **VISUAL INSPECTION**

Visually inspect the GranuFlo Dissolution Unit prior to each use.

The operator should look for any defects which may inhibit the safe or proper operation of the Unit. Items such as:

- ❑ Damaged hydraulic hoses or fittings.
- ❑ Damaged electrical cables or connections.
- ❑ Loose, missing, or damaged hardware.
- ❑ Previous process contamination should be corrected prior to the use of the GranuFlo Dissolution Unit.

# Maintenance

## Routine Maintenance Schedule

### GranuFlo 1 Unit

PROCEDURE	PER BATCH	MONTH	AS NEEDED	REF. SECTION
RINSE CYCLE	X			6
VISUAL INSPECTION	X			8.1
CLEANING SURFACES	X			8.2
DISINFECTANT			X	8.3
FILTER			X*	8.4
CORROSION		X**		N/A
SPRAY BALL			X	SECTION 6 STEP3

\* It is recommended to change the Filter after mixing 6 batches or when the 132 Gallon Dry Acid Dissolution Unit Requires Disinfection. If a tank becomes contaminated, the tank will need to be disinfected before a new filter is installed.

\*\* It is recommended that you look for corrosion or salt deposits at the Final Fill Sensor, Propellers and Shaft within the Unit's Tank. Also, look for any corrosion around the connectors at every valve. Any excessive corroded part on the unit should be clean and replaced if needed

### GranuFlo II Unit

PROCEDURE	PER BATCH	MONTH	AS NEEDED	REF. SECTION
RINSE CYCLE	X			6
VISUAL INSPECTION	X			8.1
CLEANING SURFACES	X			8.2
DISINFECTANT			X	8.3
FILTER			X*	8.6
STAND PIPE FILTER			X	8.4.2
CORROSION		X**		N/A
SPRAY BALL			X	SECTION 6 STEP3

\* It is recommended to change the Filter after mixing 6 batches or when the 99 Gallon Dry Acid Dissolution Unit Requires Disinfection. If a tank becomes contaminated, the tank will need to be disinfected before a new filter is installed.

\*\* It is recommended that you look for corrosion or salt deposits at the Final Fill Sensor and within the Unit's Tank. Also, look for any corrosion around the connectors at every valve. Any excessive corroded part on the unit should be clean and replaced if needed.



# Sodium Hypochlorite “Bleach” DISINFECTION

**Operators Manual:**  
Section 8.3

# Sodium Hypochlorite (bleach) Disinfection

## Operators Manual Section 8.3

### SODIUM HYPOCHLORITE (BLEACH) DISINFECTION

Clorox Regular Bleach (Sodium hypochlorite 5-10%)

	<u>Ingredient</u>	<u>Concentration</u>	<u>Exposure Limit</u>
	Sodium hypochlorite CAS# 7681-52-9	5 - 10%	Not established
	Sodium hydroxide CAS# 1310-73-2	<1%	2 mg/m <sup>1</sup> 2 mg/m <sup>2</sup>
*for more references please refer to the MSDS attached to this ETR.			



**WARNING!** ENSURE THE TRANSFER LINE IS NOT CONNECTED TO A CONCENTRATE STORAGE CONTAINER/TANK.

**NOTE:** USE ONLY SODIUM HYPOCHLORITE (5% TO 10%) TO DISINFECT THE GranuFlo DISSOLUTION UNIT. MAKE SURE THE BLEACH DOES NOT CONTAIN A CLEANER.

# Sodium Hypochlorite (bleach) Disinfection

## Operators Manual Section 8.3

1. Disinfect as required.
2. (A) Remove the Filter Housing and  
(B) Discard the Filter Element  
(C) Replace the Filter Housing, **but do not insert a replacement Filter at this time.** Connect the Transfer Nozzle to the end of the Transfer Line and make sure the **Transfer Nozzle Valve is CLOSED.**

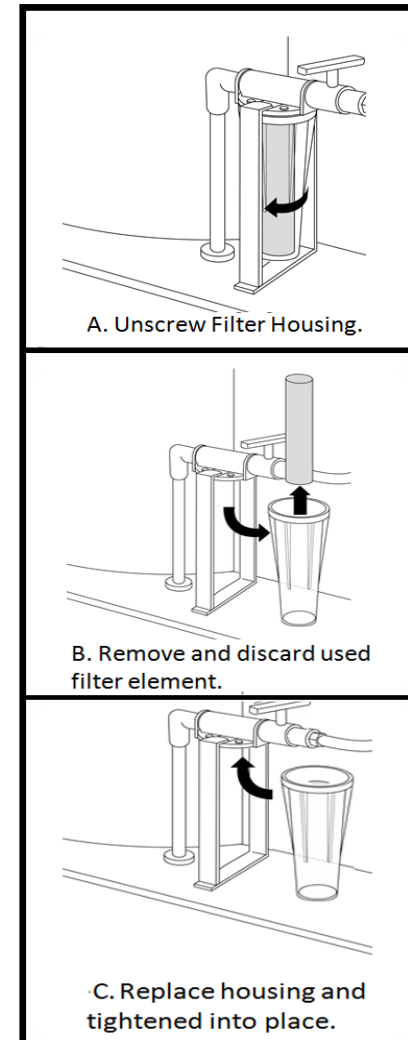

# Sodium Hypochlorite (bleach) Disinfection

## Operators Manual Section 8.3

3. Press the RINSE Start Button. The fill light indicator will turn on and the tank will fill to the 25-Gallon Sensor.
4. Once the water reaches the 25-Gallon Sensor the unit will automatically step to RECIRCULATE operation. Using your safety glasses inspect spray ball operation.
5. The unit will step to DRAIN and FILL Operations again.
6. When the water reaches the 25-Gallon Sensor during the second RINSE, add 0.5 gallons (1.9 liters) of bleach (sodium hypochlorite 5% to 10%) to the rinse water in the Tank and allow it to recirculate for the duration of the RINSE CYCLE.
7. At the completion of the last RINSE operation (to which the bleach has been added), **initiate two (2) complete RINSE CYCLES.**

When completed, Check two (2) areas for residual bleach.

**(SEE NEXT PAGE)**

# Sodium Hypochlorite (bleach) Disinfection

## Operators Manual Section 8.3

### Checking from (1) Transfer Hose

- ❑ Press Dissolution START button. When water has reached the 25 Gallon Sensor, use **STEP MODE** to skip to TRANSFER operation.
- ❑ Press the Dissolution START button. Open the Transfer Valve on the GranuFlo Dissolution Unit. Then, slowly open the Valve on the Transfer Nozzle. Allow water to flow to the drain for 30 seconds and then collect a sample to test for residual bleach. Close Transfer Nozzle Valve.

### Checking from (2) Drain Hose

- ❑ Using **STEP MODE** skip to **CYCLE COMPLETE** operation and press Dissolution **START** Button (132 Gal).
- ❑ Using **STEP MODE** skip to **DRAIN** operation and Press Rinse **START** Button (99 Gal).
- ❑ The Drain Valve will Open. Allow water to drain for 15 seconds and collect a sample from the Drain Hose to test for residual bleach.

# Sodium Hypochlorite (bleach) Disinfection

## Operators Manual Section 8.3

8. If residual bleach levels are higher than ANSI/AAMI Standard limit of <math><0.1</math> ppm (RD61: 2006), in any of the two areas initiate another complete RINSE operation. After the RINSE CYCLE is complete, start from section 8.3: number 5, to check for residual bleach. Continue the RINSE CYCLE and test procedure until bleach residuals are within ANSI/AAMI Standard limit of <math><0.1</math> ppm (RD61:2006) in both places.
9. Once you have attained an acceptable bleach residual reading, connect the Transfer Line back onto the GranuFlo Dissolution Unit Transfer Line Holder.

# Sodium Hypochlorite (bleach) Disinfection

## Operators Manual Section 8.3

10. Turn the unit's power **OFF** and ensure that the main transfer ball valve is **CLOSED**.
11. Remove Filter Housing and drain all residual water from the Housing.
12. Install new Filter and tighten Filter Housing into place (See Adjacent Figure).
13. Unhook Transfer Nozzle and place Transfer Line onto the Transfer Line Holder.
14. Immediately after RINSE CYCLE, make a batch of Dry Acid Product. Leaving the GranuFlo Dissolution Unit with only treated water or wetted with only treated water leaves the Unit susceptible to bacterial growth.

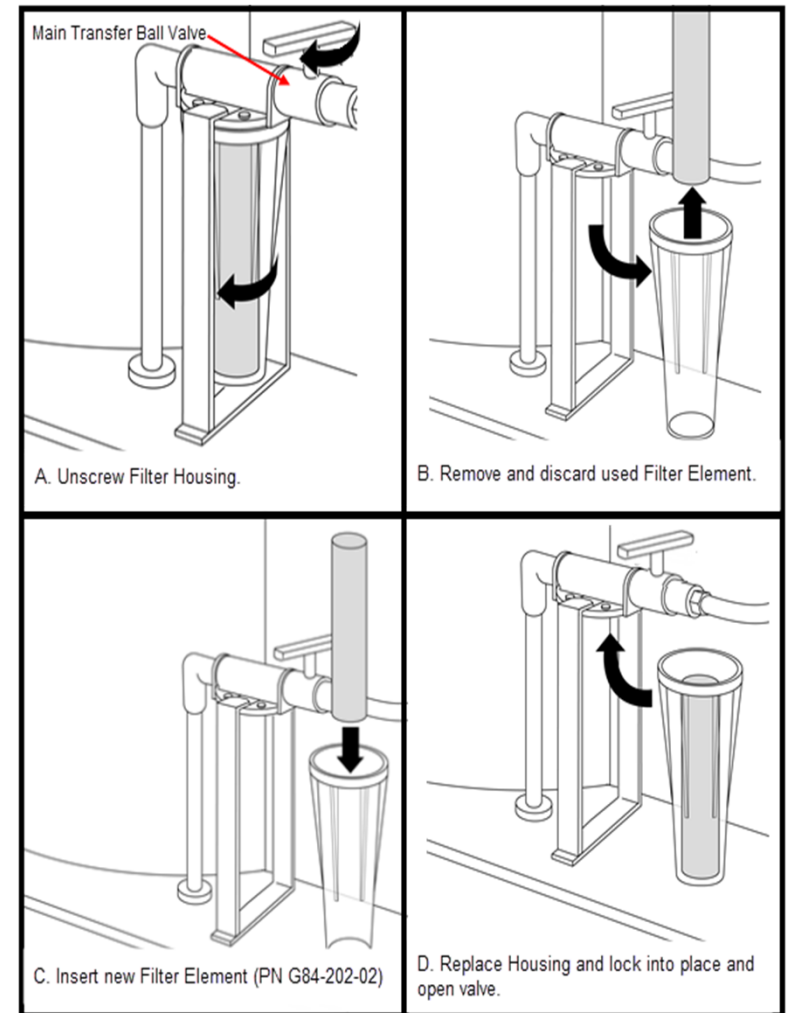

# Sodium Hypochlorite (bleach) Disinfection

## Operators Manual Section 8.3

### Sodium Hypochlorite (bleach) Disinfection Step Summary

	Cycle	Operation	Operation #	Comments/Instruction
Cycle # 0	Rinse	Fill	1	Press start on the Rinse Cycle
	Rinse	Recirculate	1	Check for Spray Ball Operation
	Rinse	Drain	1	
	Rinse	Fill	2	Press pause and add bleach (0.5 Gal or 1.9 L) then press "Rinse Start" to resume.
	Rinse	Recirculate	2	
	Rinse	Drain	2	
	Rinse	Cycle Complete	2	
Cycle # 1	Rinse	Fill	1	Press Start on Rinse Cycle (2 <sup>nd</sup> Rinse Cycle)
	Rinse	Recirculate	1	
	Rinse	Drain	1	
	Rinse	Fill	2	
	Rinse	Recirculate	2	
	Rinse	Drain	2	
	Rinse	Cycle Complete	2	
Cycle # 2	Rinse	Fill	1	Press Start on Rinse Cycle (2 <sup>nd</sup> Rinse Cycle)
	Rinse	Recirculate	1	
	Rinse	Drain	1	
	Rinse	Fill	2	
	Rinse	Recirculate	2	
	Rinse	Drain	2	
	Rinse	Cycle Complete	2	
	Dissolution	Fill	Step Mode	
	Dissolution	Transfer	Step Mode	Test from Transfer line**
	Dissolution	Cycle Complete	Step Mode	Test from Drain **

\*\* If residual bleach levels of samples are higher than 0.1 ppm. Continue rinse cycle and test until bleach residuals are less than 0.1 ppm.

After Disinfection is completed, remember to make a batch of Dry Acid product.



# Transfer Filter and Base Stand Pipe Filter Replacement

**Operators Manual:**  
Section 8.4

# FILTER REPLACEMENT

## Operators Manual Section 8.4

### TRANSFER FILTER REPLACEMENT

#### WHEN?

- The Filter shall be changed **AFTER** mixing **6 BATCHES**.
- When the GranuFlo Dissolution Unit requires **DISINFECTION**.

#### NOTE

THE FILTER USED MUST BE COMPATIBLE WITH FRESENIUS MEDICAL CARE DRY ACID PRODUCT AND RATED AT 1 MICRON. FRESENIUS MEDICAL CARE. P/N G84-202-12 IS A POLYPROPYLENE FIBER WOUND ON A POLYPROPYLENE MESH CORE AND MEETS THESE REQUIREMENTS. CELLULOSE FILTERS ARE NOT COMPATIBLE WITH THE FRESENIUS MEDICAL CARE DRY ACID PRODUCT AND WILL BREAK DOWN, CLOGGING AFTER ONLY A FEW BATCHES.

# FILTER REPLACEMENT

## Operators Manual Section 8.4

### TRANSFER FILTER REPLACEMENT

#### HOW?

- Ensure Mixing Tank is empty
- Power to the GranuFlo Dissolution Unit has been turned off.
- MAIN TRANSFER BALL VALVE is closed.
- Follow the Figure A, B, C, and D for removal and replacement of the filter.

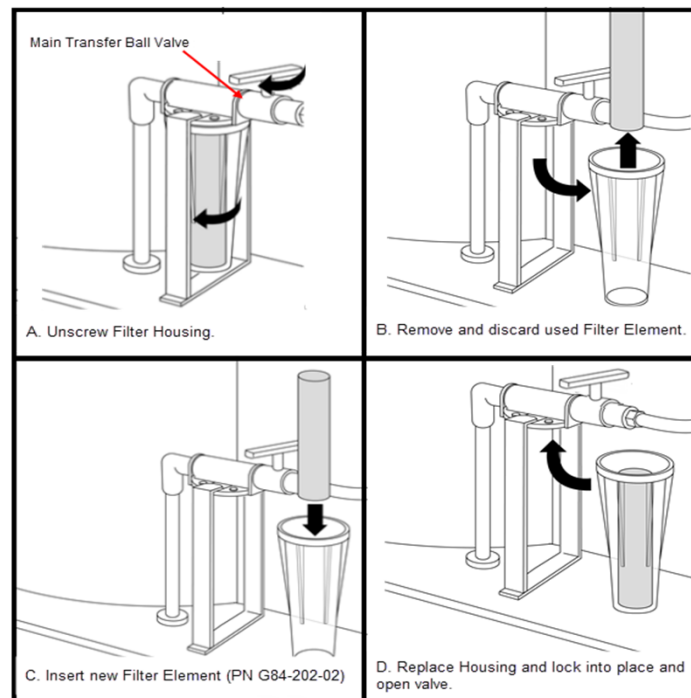

# SENSOR REPLACEMENT

## Operators Manual: Section 8.5

# SENSOR REPLACEMENT

## Operators Manual Section 8.5

### Sensor Replacement

**NOTE: IF THE FINAL FILL SENSOR NEEDS ADJUSTMENT OR REPLACEMENT, THEN A QUALIFIED TECHNICAL PERSONNEL SHALL COMPLETE THIS AND THE FOLLOWING TASKS. SAMPLE MUST BE DRAWN FROM THE FIRST BATCH OF CONCENTRATE MIXED. THIS SAMPLE MUST BE ANALYZED FOR CORRECT SOLUTION MIX BEFORE THE CONCENTRATE CAN BE USED. BEFORE REPLACING THE FINAL FILL SENSOR OR RELOCATING THE DRY ACID DISSOLUTION UNIT CONTACT FRESENIUS MEDICAL CARE TECHNICAL SERVICE AT 1 (800) 227-2572 AND REQUEST TWO (2) EMPTY SAMPLE BOTTLES (P/N G83-535-02). SEE APPENDIX D OF THE OPERATORS MANUAL FOR FURTHER INSTRUCTIONS.**

**(1) Request 2 Empty sample bottles (P/N G83-535-02).**



**(2) Follow Appendix D**

- APPENDIX D: FIRST BATCH VERIFICATION INSTRUCTIONS**
- Once the Final Fill Sensor is replaced or unit relocated and the empty sample bottles are available. Plug in the power cord. Turn treated water on. Turn the power switch ON (Red switch on the right side of the GranuFlo Dissolution Unit II). Verify the power light activates.
  - As per the Operators Manual section 6.0, secure the tank lid and initiate the RINSE CYCLE.
  - As per the Operators Manual section 7.0, run a DISSOLUTION CYCLE by pressing the DISSOLUTION Start Button. When the Add Granules Light flashes check to make sure water has reached the Mid-Level Sensor, and then add the six (6) boxes of GranuFlo® or Citrasate® DRY product.  
**NOTE: MAKE SURE TO FILL THE PRODUCTION BATCH RECORD FORM ATTACHED TO THIS MANUAL WITH THE PRODUCT INFORMATION.**  
**WARNING: DO NOT USE ANY BOX OF GRANUFLO® OR CITRASATE® DRY CONCENTRATE THAT HAS BEEN OPENED OR TAMPERED WITH. IT IS IMPORTANT THAT THE ENTIRE CONTENTS OF EACH BOX ARE EMPTIED INTO THE DISSOLUTION TANK.**  
**WARNING: THE USE OF EYE PROTECTION AND GLOVES IS RECOMMENDED WHEN HANDLING DRY ACID PRODUCT. IF CONTACT WITH EYES, RINSE IMMEDIATELY FOR 15 MINUTES. IF CONTACT WITH SKIN, FLUSH WITH PLENTY OF SOAP AND WATER. SEE MATERIAL SAFETY DATA SHEETS (MSDS) FOR THE DRY ACID PRODUCT BEING USED FOR FURTHER PERSONAL PROTECTIVE EQUIPMENT (PPE) OR EMERGENCY REQUIREMENTS/INSTRUCTIONS.**
  - As per the Operators Manual section 7.1, perform the *Specific Gravity* Test and record the results on the production batch record form.
  - Collect a sample of the final product(s) using the (2) sample bottles. The product sample(s) will be analyzed in accordance to manufacturer's product specifications. If only one product code is being used, collect two (2) samples of that product to be analyzed.
  - Place the sample bottles and the following completed forms into a shipping box:
    - Copy of the Production Record Form (Operator's Manual – Form 1 or Form 2)
    - Batch Analysis Form (Operator's Manual pg 44)
  - Cutout and affix the pre-printed mailing label from the Batch Analysis Form to the box. It is the responsibility of the RES to ship the samples to the "Ship To" address on the Batch Analysis Form. Contact Fresenius Medical Care Laboratory at (972) 929-7291 for results.
  - NOTICE:** The composition of the first batch of GranuFlo® / Citrasate® DRY product must be tested by a qualified testing laboratory to ensure that the resulting product meets the GranuFlo® / Citrasate® DRY product specifications. If final solution did not meet final batch criteria for use, the batch of concentrate must be discarded (See Section 13: CONCENTRATE SOLUTION DISPOSAL, PAGE 37).

**(3) Ship Samples Using BATCH ANALYSIS FORM**



#### BATCH ANALYSIS FORM Customer Information Form

**NOTE: TO PREVENT BATCH ANALYSIS DELAYS, THIS FORM MUST BE COMPLETE AND ACCURATE.**

Client Name: \_\_\_\_\_

Contact Name: \_\_\_\_\_ Contact Phone Number: \_\_\_\_\_

Client Fax Number: \_\_\_\_\_ OR Email: \_\_\_\_\_ @ \_\_\_\_\_

Dissolution Tank Serial Number: \_\_\_\_\_

Product Catalog Number: \_\_\_\_\_  
Important: Incorrect catalog number will affect the test results.

Lot Number: \_\_\_\_\_

Date Sample Taken: \_\_\_\_\_ Sample By: \_\_\_\_\_

**Ship To:**

Fresenius Medical Care  
Irving Manufacturing  
5201 Regent Blvd., Suite 100  
Irving, TX 75063  
Attention: Laboratory  
Ship: **Overnight**

# Disposal of Concentrate Solution

## Operators Manual: Section 13



**Residual Solutions**  
**“Bucket Disposal”**  
Section 13.1

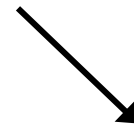

**“Tank Disposal”**  
Section 13.2

# DISPOSAL of CONCENTRATE SOLUTION

## 13.1: RESIDUAL SOLUTION BUCKET DISPOSAL

There are three occasions that require the need to discard residual solution. Those occasions are described as follows:

- **Filter Housing Residual:** Whenever you have to change out a Filter, then the solution in the Filter Housing shall be poured into the *Residual Solution Bucket*.
- **Hydrometer Cylinder Residual:** Once you are complete with the Specific Gravity Test, the solution in the Hydrometer Cylinder shall be poured into the *Residual Solution Bucket*.
- **Initial 3.5 Gallon Transferred Solution:** This is the 3.5 gallons of solution transferred into the *Residual Solution Bucket* in the beginning part of the Specific Gravity Test, section 7.1.

# DISPOSAL of CONCENTRATE SOLUTION

## 13.2: TANK SOLUTION DISPOSAL

There are five occasions in which you will need to discard the solution in the Dry Acid Dissolution Unit. Those occasions are described as follows:

- **Expired Solution:** If solution remains in the Dry Acid Dissolution Unit Tank for more than 14 days.
- **Foreign Object:** Any foreign object falling into the Dry Acid Dissolution Unit Tank after the dry acid product has been added.
- **Incorrect Catalog Used:** Any batch preparation with incorrect dry acid product catalog (s) numbers
- **Specific Gravity Out of Range:** Any batch prepared that has been found out of range.
- **Dry Acid Unit Needing Service:** Any Dry Acid Dissolution Unit that contains solution that becomes inoperable.



# DISPOSAL of CONCENTRATE SOLUTION

*c o n t i n u e d*

## **CONCENTRATE SOLUTION DISPOSAL PROCEDURE:**

MIXED DRY ACID CONCENTRATE SOLUTION HAS A PH BELOW 6. THEREFORE, IF YOU MUST DISPOSE OF ACID CONCENTRATE SOLUTION BECAUSE OF ONE OF THE ABOVE SITUATIONS, YOU SHOULD FOLLOW ANY APPLICABLE DISPOSAL REQUIREMENTS OF YOUR LOCAL, STATE, AND/OR FEDERAL AUTHORITIES. SEE CLINIC MANAGER FOR MORE INFORMATION.



---

**WARNING! SOME CHEMICALS USED TO NEUTRALIZE ACID CONCENTRATE SOLUTIONS MAY CAUSE SPLATTERING AND/OR GENERATE DANGEROUS LEVELS OF GASES WHEN COMBINED. FOR EXAMPLE, POTENTIALLY DANGEROUS LEVELS OF CARBON DIOXIDE MAY BE RELEASED WHEN SODIUM BICARBONATE IS USED AS THE NEUTRALIZING AGENT. PLEASE CAREFULLY CONSIDER THESE ISSUES, INCLUDING PROPER VENTILATION, IF NEUTRALIZATION IS REQUIRED.**

---

# DISPOSAL of CONCENTRATE SOLUTION

*c o n t i n u e d*

Immediately after a tank disposal, step unit to CYCLE COMPLETE, press STEP MODE button to turn OFF, then ensure that the water inlet valve is open and perform two (2) RINSE CYCLES by pressing the RINSE CYCLE start button and by pressing it again when the first RINSE CYCLE is completed.

After completing two (2) full RINSE CYCLES visually inspect if there is any powder deposits remaining in the tank. These can be removed by running additional RINSE CYCLES in the unit.

Immediately after rinsing the tank clean, make a batch of Dry Acid Product. Leaving the GranuFlo I Dissolution Unit with only treated water or wetted with only treated water leaves the Unit susceptible to bacterial growth.

---

**CAUTION!** DO NOT ALLOW THE UNIT TO REMAIN FULL OF WATER WITHOUT THE ADDITION OF FRESENIUS MEDICAL CARE DRY ACID PRODUCT. BACTERIAL GROWTH MAY OCCUR.

---

# Manual Control Operations

# MANUAL CONTROL OPERATIONS

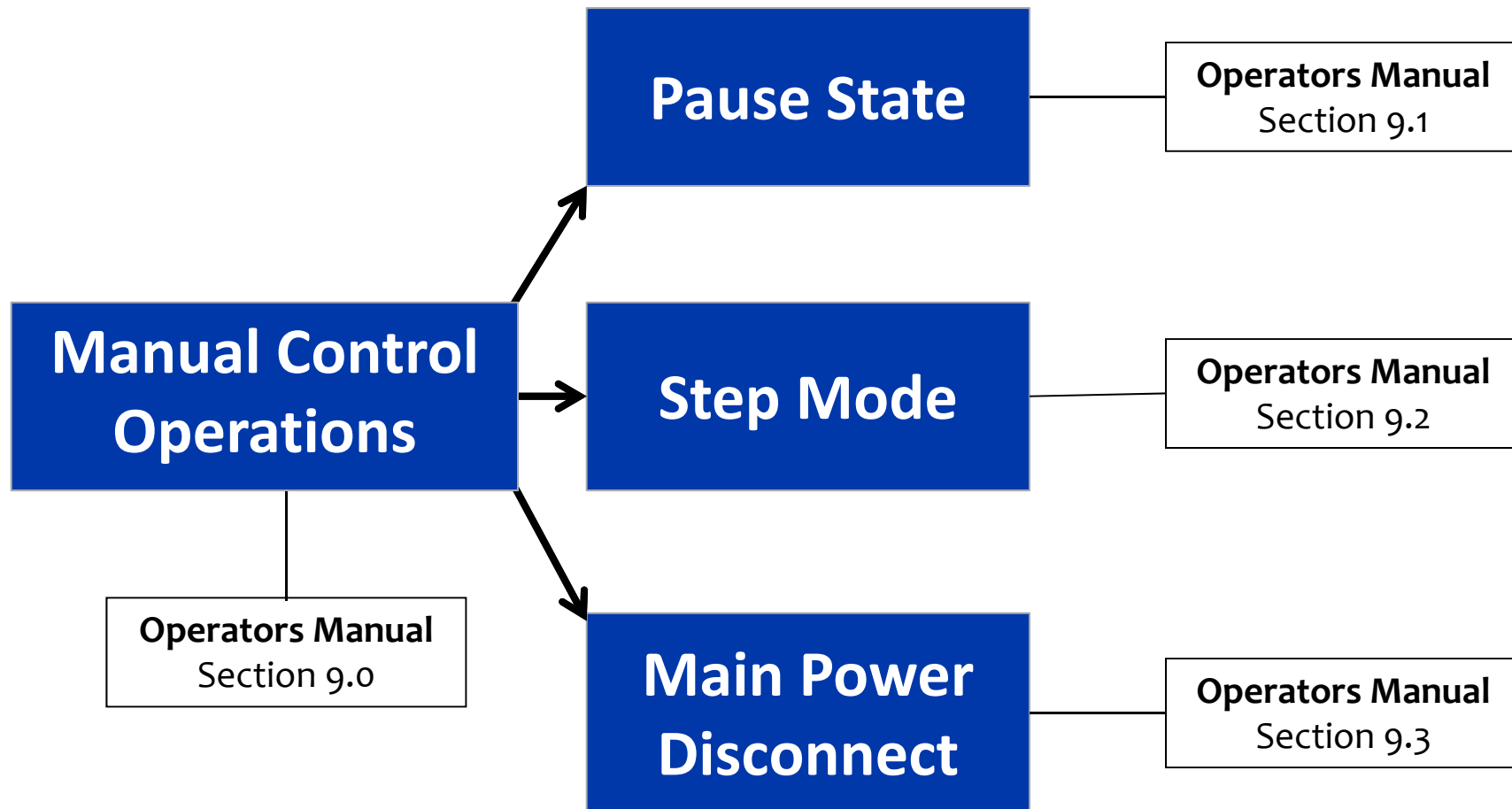

# MANUAL CONTROL OPERATIONS

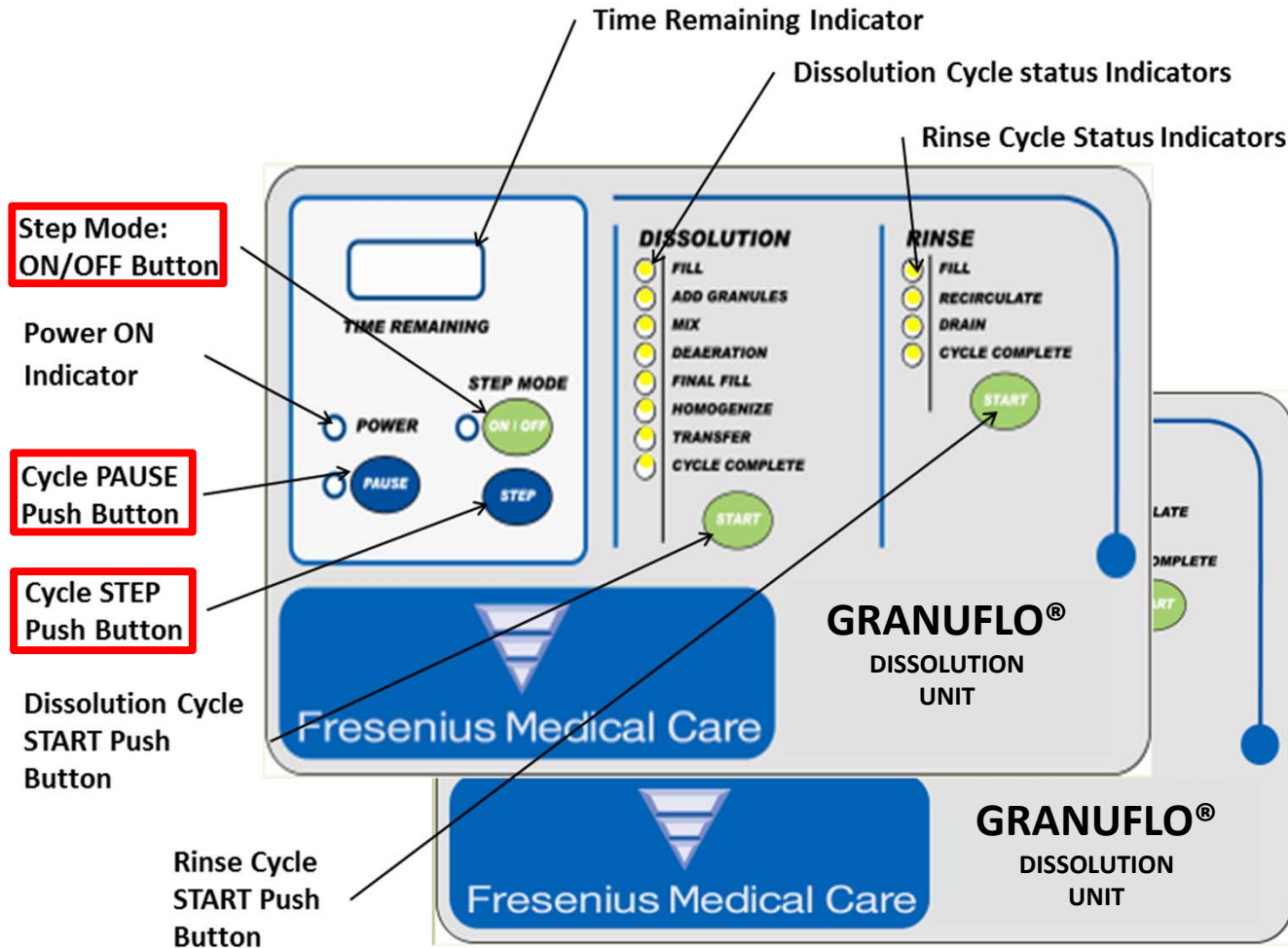

# MANUAL CONTROL OPERATIONS

## Pause State

### PAUSE STATE

If at any time the operator needs to PAUSE a timed operation during the cycle, the PAUSE button may be pressed.

- This will cause the Indicating light for the current step of the operation to flash.
- In the PAUSE state Pressing the PAUSE button or placing the control into the **STEP MODE** will disable the pump, agitators, drains, fill valves, etc.
- To continue the cycle, press the START button and the timers will resume.

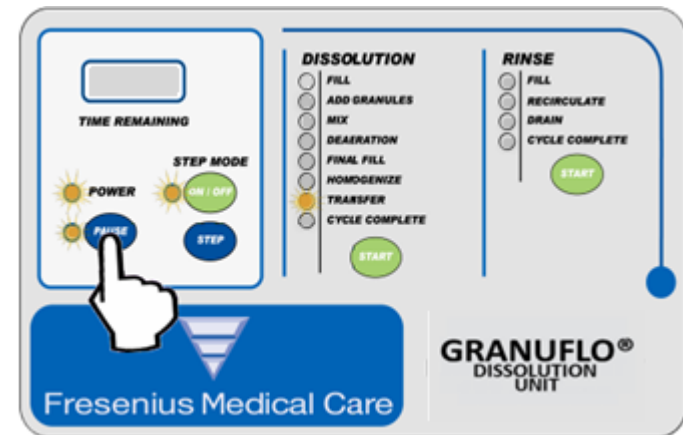

# MANUAL CONTROL OPERATIONS

## Step Mode

### When to Use it?

The STEP MODE function is intended to be used during the Disinfection operation or when it is necessary to discard an incorrectly mixed batch of solution.

### How To Use it?

- Press the **STEP MODE ON/OFF** button
- The step Mode Indicator light will illuminate.
- System will enter STEP MODE and all operations will be suspended.
- Press **STEP** button to skip to desired operation. (operation indicator light will illuminate)
- Press the **STEP MODE ON/OFF** button and the operation is continued.

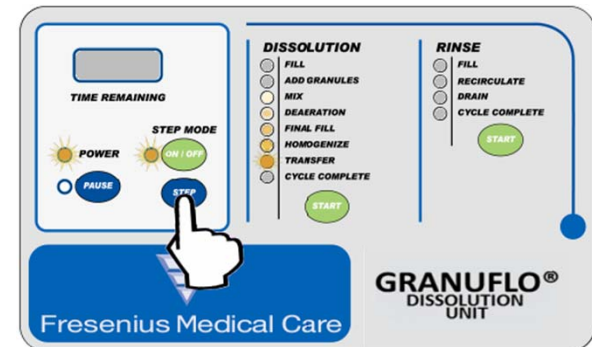
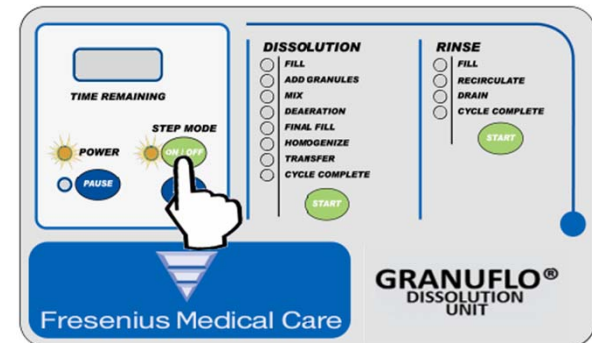

# MANUAL CONTROL OPERATIONS

## Main Power Disconnect

### MAIN POWER DISCONNECT

The MAIN POWER Switch is provided to allow the operator to completely shut down the power to the GranuFlo Dissolution Unit.

The Main Power Disconnect Switch should be switched to the OFF position when the GranuFlo Dissolution Unit is not in use or in case of an emergency.

Remove POWER PLUG from wall receptacle to disconnect power. A 'LOCKOUT' device may be used to prevent unauthorized start up.



# Appendix and Forms

# OPERATORS MANUAL APPENDIX A

## SPECIFIC GRAVITY RANGES

### APPENDIX A: GRANUFLO DRY ACID TABLE OF SPECIFIC GRAVITIES

#### Specific Gravity Ranges

1:44 PROPORTIONING

Catalog Number		17°C to 21°C		22°C to 26°C		27°C to 31°C	
		Low	High	Low	High	Low	High
1K	OFD1251-3B	1.191	1.203	1.188	1.200	1.186	1.198
	OFD2201-3B	1.191	1.203	1.189	1.201	1.187	1.199
2K	OFD2231-3B	1.192	1.204	1.190	1.202	1.187	1.199
	OFD2251-3B	1.192	1.204	1.190	1.202	1.188	1.200
	OFD2301-3B	1.193	1.205	1.191	1.203	1.189	1.201
3K	OFD3201-3B	1.193	1.205	1.191	1.203	1.188	1.200
	OFD3231-3B	1.194	1.206	1.191	1.203	1.189	1.201
	OFD3251-3B	1.194	1.206	1.192	1.204	1.189	1.201
	OFD3301-3B	1.195	1.207	1.193	1.205	1.190	1.202

Thermometer Specifications: Temperature Range 25° C +/-5°C (68° to 86° F) and accuracy +/- 1°C (3.6 °F)

**For Reference Only.**  
**See Appendix A in Operator's Manual**

# OPERATORS MANUAL APPENDIX B

## SPECIFIC GRAVITY RANGES

### APPENDIX B: CITRASATE® DRY SPECIFIC GRAVITIES TABLE

#### Specific Gravity Ranges

1:44 PROPORTIONING

Catalog Number		17°C to 21°C		22°C to 26°C		27°C to 31°C	
		Low	High	Low	High	Low	High
1K	OFD1231-DA	1.191	1.203	1.189	1.201	1.187	1.199
	OFD1251-DA	1.192	1.204	1.189	1.201	1.187	1.199
2K	OFD2231-DA	1.193	1.205	1.191	1.203	1.189	1.201
	OFD2251-DA	1.193	1.205	1.191	1.203	1.189	1.201
	OFD2301-DA	1.194	1.206	1.192	1.204	1.190	1.202
3K	OFD3231-DA	1.195	1.207	1.193	1.205	1.190	1.202
	OFD3251-DA	1.195	1.207	1.193	1.205	1.191	1.203
	OFD3301-DA	1.196	1.208	1.194	1.206	1.192	1.204

Minimum Thermometer Specifications: Temperature Range 25° C +/-5°C  
(68° to 86° F) and accuracy +/- 1°C (3.6 °F)

**For reference only.  
See Appendix B in Operator's Manual**

# OPERATORS MANUAL APPENDIX C

**GranuFlo®**
**Citrasate® Dry**

## FMCNA DRY Acid Mixing Procedure Card

This card is intended to be a supplement to the FMCNA Dry Acid Dissolution Unit Operators Manual and the Citrasate® Dry /GranuFlo® product labels. Refer to the FMCNA Dry Acid Dissolution Unit Operators Manual and the Citrasate Dry/GranuFlo product labels for a complete description of mixing instructions, hazards, contraindications and precautions.

### Preparation for Dissolution Cycle

**i** Note: FMCNA Dry Acid Dissolution Units are designed for use with Citrasate Dry or GranuFlo Acid products only  
Note: Do not use GranuFlo or Citrasate Dry cases if package is opened or damaged

**Step 1** Determine how much product is required for mixing (See Table 1 below)

FMCNA Dry Acid Dissolution Unit	No. of Cases Needed
99 gallon mixer	6
132 gallon mixer	8

Table 1: Citrasate Dry /GranuFlo Case Requirements

**Step 2** Check case labels to ensure all cases are of the same catalogue number.

**Step 3** Complete the Dry Acid Batch Production Record form.

**Step 4** Use water that meets or exceeds ANSI/AAMI RD62 or ISO 13959 hemodialysis water quality standards. Water temperature should be 20C – 30C (68F – 86F) for proper dissolution.

### Instructions for Dissolution

**i** Note: The contents in the GranuFlo or Citrasate Dry cases may clump or harden. This does not affect the chemical composition of the product

*Rinse Cycle must be completed prior to initiating the batch of concentrate*

**Step 1** Ensure Access Port Lid is in place, Transfer Valve is closed and Input Water Source is On.

**Step 2** Press the RINSE START button.



**Step 3** Begin the Fill Cycle on the FMCNA Dry Acid Dissolution Unit by pressing the DISSOLUTION START button.

**Step 4** Wait for the ADD GRANULES light prior to adding dry acid product.

**Step 5** Put on PPE.

**Step 6** Remove small access lid on FMCNA Dry Acid Dissolution Unit.

**Step 7** Open a case of GranuFlo/Citrasate Dry and cut off the tops of all bags just below the bag seal, leaving as much extra bag length as possible. When using Citrasate Dry, do not cut off top of small, orange acetate bag until immediately prior to adding.

**For Reference Only. See Appendix C in Operator's Manual**

**GranuFlo®**
**Citrasate® Dry**

## Instructions for Dissolution (Continued)

**Step 8** Gather extra bag material at the top with your thumb facing down. This will allow the proper hand position when the bag is inverted.

**Step 9** Grab the flap on the bottom of the bag and invert the bag. Insert the gathered end into the small opening in the FMCNA Dry Acid Dissolution Unit.

**Step 10** Release the gathered end of the bag and allow the contents to empty into the tank. Once all of the powder has transferred to the dissolution unit remove and discard the empty bag.

**Step 11** Repeat steps 7-10 until the correct number of bags have been emptied into the Dry Acid Dissolution Unit

**i** Note: The contents of the bags in each case are different. All bags must be used.

**Step 12** Dry off the Upper Level Sensors.









**Step 13** Label the FMCNA Dry Acid Dissolution Unit with contents and dates prepared.

**Step 14** Replace the small access lid and press the DISSOLUTION START button. The Dissolution Unit will proceed to the Mix Operation. Follow the FMCNA Dry Acid Dissolution Unit Operator Manual for instruction to complete the mixing process.

**Step 15** Once the Transfer Indicator Light flashes, the concentrate can be tested for the specific gravity.

**Step 16** After the Specific Gravity value is found to be acceptable, follow the FMCNA Dry Acid Dissolution Unit Operators Manual to transfer the solution to appropriate storage containers.

**i** Note: Reconstituted acid concentrate should not be stored in the Dry Acid Dissolution tank for longer than two weeks from the date of dissolution

Fresenius Medical Care North America, 530 Winter Street, Waltham, MA 02451, url: www.freseniusmedicalcare.com  
FMCNA Customer Service: 800-323-5188, Technical Support: 800-227-2572  
©2011 Fresenius Medical Care North America. All rights reserved. Fresenius Medical Care, the triangle logo, and GranuFlo are registered trademarks of Fresenius Medical Care Holdings, Inc. Citrasate is a registered trademark of Advanced Renal Technologies (ART) in the United States and is used under license from Advanced Renal Technologies.

# OPERATORS MANUAL APPENDIX D

**For Reference Only.  
See Appendix D in Operator's Manual**

## APPENDIX D: FIRST BATCH VERIFICATION INSTRUCTIONS

1. Once the Final Fill Sensor is replaced or unit relocated and the empty sample bottles are available. Plug in the power cord. Turn treated water on. Turn the power switch ON (Red switch on the right side of the GranuFlo I Dissolution Unit). Verify the power light activates.
2. As per the Operators Manual section 6.0, secure the tank lid and initiate the RINSE CYCLE.
3. As per the Operators Manual section 7.0, run a DISSOLUTION CYCLE by pressing the DISSOLUTION Start Button. When the ADD GRANULES light flashes check to make sure water has reached the Mid-Level Sensor, and then add the eight (8) boxes of GranuFlo® or Citrasate® DRY product.



**NOTE: MAKE SURE TO FILL THE PRODUCTION BATCH RECORD FORM ATTACHED TO THIS MANUAL WITH THE PRODUCT INFORMATION.**



**WARNING: DO NOT USE ANY BOX OF GRANUFLO® OR CITRASATE® DRY CONCENTRATE THAT HAS BEEN OPENED OR TAMPERED WITH. IT IS IMPORTANT THAT THE ENTIRE CONTENTS OF EACH BOX ARE EMPTIED INTO THE DISSOLUTION TANK.**



**WARNING! THE USE OF EYE PROTECTION, DUST MASK AND GLOVES IS RECOMMENDED WHEN HANDLING DRY ACID PRODUCT. IF CONTACT WITH EYES, RINSE IMMEDIATELY FOR 15 MINUTES. IF CONTACT WITH SKIN, FLUSH WITH PLENTY OF SOAP AND WATER. SEE MATERIAL SAFETY DATA SHEETS (MSDS) FOR THE DRY ACID PRODUCT BEING USED FOR FURTHER PERSONAL PROTECTIVE EQUIPMENT (PPE) OR EMERGENCY REQUIREMENTS/INSTRUCTIONS.**

4. As per the Operators Manual section 7.1, perform the *Specific Gravity* Test and record the results on the production batch record form.
5. Collect a sample of the final product(s) using the (2) sample bottles (P/N G83-535-02). The product sample(s) will be analyzed in accordance to manufacturer's product specifications. If only one product code is being used, collect two (2) samples of that product to be analyzed.
6. Place the sample bottles and the following completed forms into a shipping box:
  - Copy of Batch Production Record Form (Operator's Manual – Form 1 or Form 2)
  - Batch Analysis Form (Operator's Manual pg 43)
7. Cutout and affix the pre-printed mailing label from the Batch Analysis Form to the box. It is the responsibility of the RES to ship the samples to the "Ship To" address on the Batch Analysis Form. Contact Fresenius Medical Care Laboratory: at (972)-929-7291 for results.
8. NOTICE: The composition of the first batch of GranuFlo® / Citrasate® DRY product must be tested by a qualified testing laboratory to ensure that the resulting product meets the GranuFlo® / Citrasate® DRY product specifications. If final solution did not meet final batch criteria for use, the batch of concentrate must be discarded (SEE SECTION 13: CONCENTRATE SOLUTION DISPOSAL PROCEDURES, PAGE 37).

# OPERATORS MANUAL

## FORM 1: GranuFlo® Batch Production Record

FORM 1: GRANUFLO® BATCH PRODUCTION RECORD

Dialysis Unit Name & Location #:		GranuFlo I Dissolution Unit Serial #:	
<b>DRY ACID PRODUCT CASE INFORMATION</b>			
OPERATOR (print name):		DATE:	TIME: Batch #:
CASE 1: Dry Acid Catalog # (label on box)	BOX Lot #		Potassium # (1K, 2K, 3K)
CASE 2: Dry Acid Catalog #	BOX Lot #		Potassium #
CASE 3: Dry Acid Catalog #	BOX Lot #		Potassium #
CASE 4: Dry Acid Catalog #	BOX Lot #		Potassium #
CASE 5: Dry Acid Catalog #	BOX Lot #		Potassium #
CASE 6: Dry Acid Catalog #	BOX Lot #		Potassium #
CASE 7: Dry Acid Catalog #	BOX Lot #		Potassium #
CASE 8: Dry Acid Catalog #	BOX Lot #		Potassium #
1. After Final Fill Level has been reached, CLOSE water supply valve to the Unit. Once this is done check the box <input type="checkbox"/>			
<b>SPECIFIC GRAVITY</b>			
Measured Temp	Print Catalog # - Specific Gravity Value for the Measured Temp listed in Appendix A:		Measured Specific Gravity Value: Check one
TEMP:	LOW:	HIGH:	<input type="checkbox"/> -Pass
			<input type="checkbox"/> -Fail (void section)
OPERATOR SIGNATURE:		VERIFIER SIGNATURE:	

For Reference Only.  
See form in Operator's Manual

# OPERATORS MANUAL

## FORM 2: Citrasate® DRY Batch Production Record

FORM 2: CITRASATE® DRY WITH ACETATE PRODUCTION RECORD

DIALYSIS UNIT NAME & LOCATION #:		GranuFlo I Dissolution Unit Serial #:	
<b>DRY ACID PRODUCT CASE INFORMATION</b>			
OPERATOR (print name):	DATE:	TIME:	Batch #:
CASE 1: Dry Acid Catalog # (label on box)	BOX Lot #	4 <sup>th</sup> bag used ✓ box Yes <input type="checkbox"/>	Potassium # (1K, 2K, 3K)
CASE 2: Dry Acid Catalog #	BOX Lot #	4 <sup>th</sup> bag used ✓ box Yes <input type="checkbox"/>	Potassium #
CASE 3: Dry Acid Catalog #	BOX Lot #	4 <sup>th</sup> bag used ✓ box Yes <input type="checkbox"/>	Potassium #
CASE 4: Dry Acid Catalog #	BOX Lot #	4 <sup>th</sup> bag used ✓ box Yes <input type="checkbox"/>	Potassium #
CASE 5: Dry Acid Catalog #	BOX Lot #	4 <sup>th</sup> bag used ✓ box Yes <input type="checkbox"/>	Potassium #
CASE 6: Dry Acid Catalog #	BOX Lot #	4 <sup>th</sup> bag used ✓ box Yes <input type="checkbox"/>	Potassium #
CASE 7: Dry Acid Catalog #	BOX Lot #	4 <sup>th</sup> bag used ✓ box Yes <input type="checkbox"/>	Potassium #
CASE 8: Dry Acid Catalog #	BOX Lot #	4 <sup>th</sup> bag used ✓ box Yes <input type="checkbox"/>	Potassium #
<b>SPECIFIC GRAVITY</b>			
Measured Temp TEMP:	Print Catalog # -Specific Gravity Value for the Measured Temp listed in Appendix A: LOW:	HIGH:	Measured Specific Gravity Value:  Check one <input type="checkbox"/> Pass <input type="checkbox"/> Fail (void section)
1. After Final Fill Level has been reached, CLOSE water supply valve to the Unit. Once this is done check the box			<input type="checkbox"/>
OPERATOR SIGNATURE:		VERIFIER SIGNATURE:	

For Reference Only.  
See form in Operator's Manual

# BASE STAND PIPE FILTER

(Only on the 99 Gal, Operators Manual Sec 8.4.2)

## BASE STAND PIPE FILTER REMOVAL

- Using Base Filter Rod, P/N 260025 (A)
- Reach into the tank and connect the small end of the shaft into the Screw Nut of Base Filter (B).
- Turn the Screw Nut Counter Clockwise until the Base Stand Pipe Filter is no longer attached to the tank.
- Use the Base Filter Rod to help lift the Base Stand Pipe Filter out of Tank.

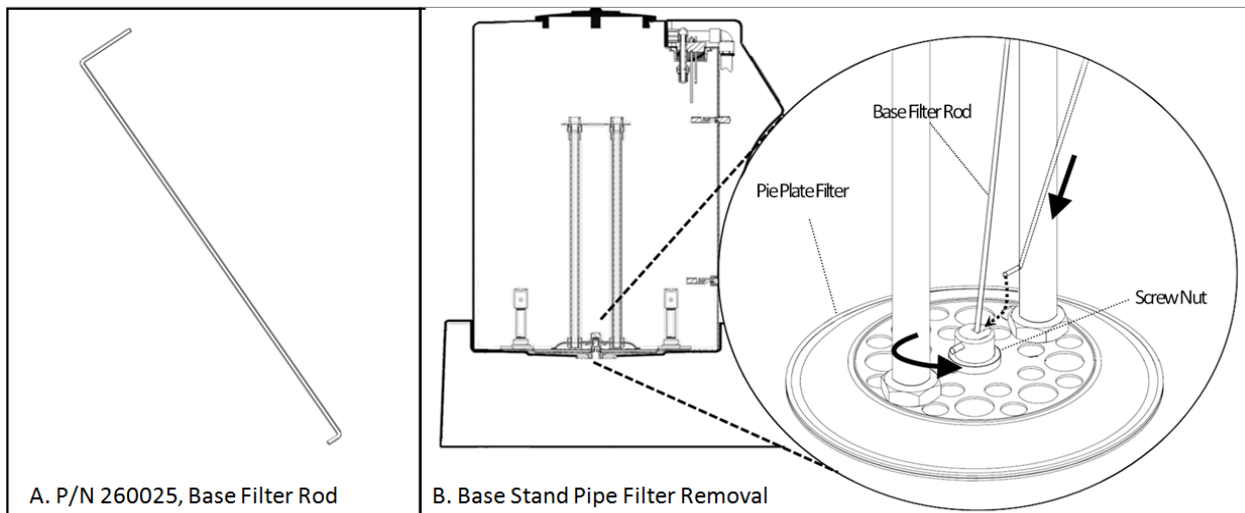

### After Removing the Base Stand Pipe Filter.

- Clean with purified water
- Re-install



# Copyright and Trademark Statements

© 2014, 2016, 2017 Fresenius Medical Care, All Rights reserved.

Fresenius Medical Care, the triangle logo and GranuFlo are trademarks of Fresenius Medical Care Holdings, Inc. or its affiliated companies. Citrasate is a registered trademark of Advanced Renal Technologies in the United States and is used under license from Advanced Renal Technologies. All other trademarks are the property of their respective owners.