

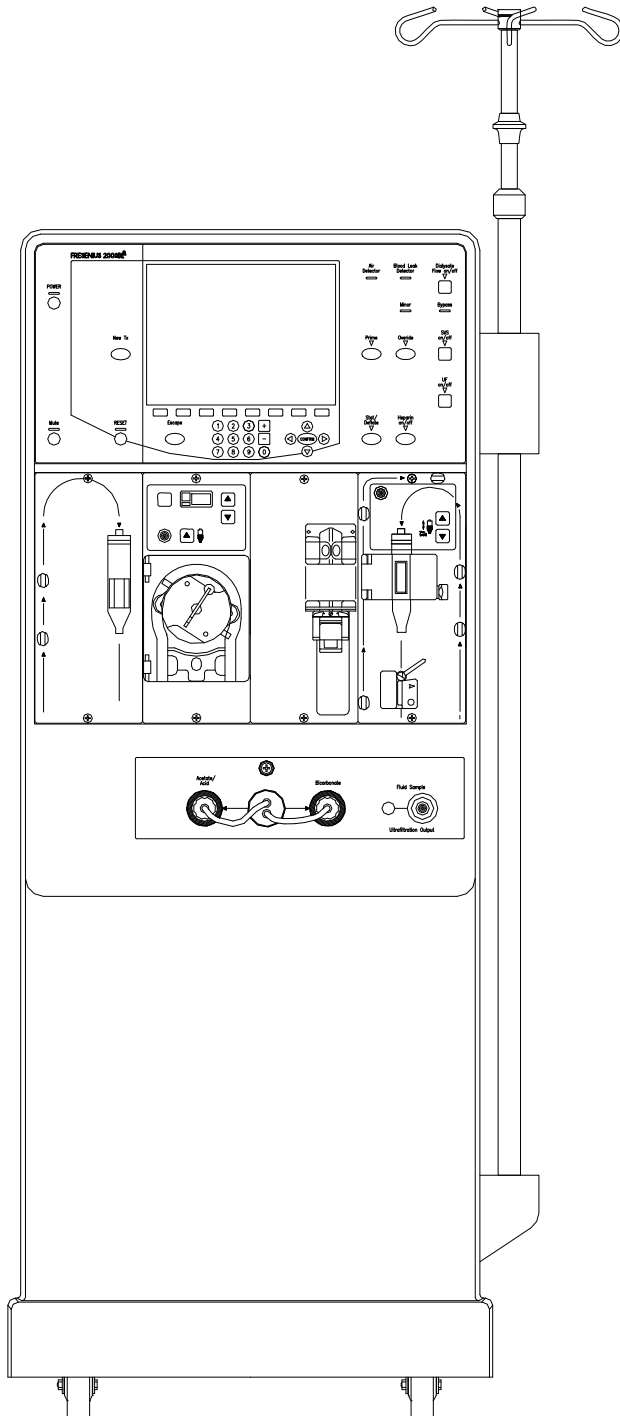

**FRESENIUS  
MEDICAL CARE**



2008K<sup>2</sup>  
HEMODIALYSIS  
SYSTEM

PREVENTIVE  
MAINTENANCE  
PROCEDURES

Part Number 508138 Rev. I

# FRESENIUS MEDICAL CARE NORTH AMERICA

**800-227-2572**

**Fresenius Medical Care North America  
920 Winter St.  
Waltham, MA 02451**

**Manufactured by:  
Fresenius USA, Inc.  
4040 Nelson Avenue  
Concord, CA 94520**

# **2008K<sup>2</sup>**

# **HEMODIALYSIS SYSTEM**

## **PREVENTIVE MAINTENANCE PROCEDURES**

Part Number 508138 Rev. I

**INCLUDING  
PREVENTIVE MAINTENANCE CHECKLISTS  
SIX (6) MONTH AND ANNUAL/4000 HOUR**

<http://www.fmcna.com>

Copyright © 2008 - 2017 Fresenius Medical Care, All Rights Reserved

## **2008K<sup>2</sup> Preventive Maintenance Procedures**

*This document contains proprietary information of Fresenius USA, Inc. d/b/a Fresenius Medical Care North America and its affiliates (“Fresenius Medical Care”). The contents of this document may not be disclosed to third parties, copied, or duplicated in any form, in whole or in part, without the prior written permission of Fresenius Medical Care.*

*Fresenius Medical Care, the triangle logo, 2008 and DIASAFE are trademarks of Fresenius Medical Care Holdings, Inc., or its affiliated companies. All other trademarks are the property of their respective owners.*





*Caution: US Federal law restricts this device to sale only by or on the order of a physician. Frequency, duration, and parameters of treatment are to be determined by the prescribing physician.*

*Installation, maintenance, calibration and other technical information may be found in the 2008K<sup>2</sup> Technician’s Manual, P/N 490137.*

*Contact Fresenius Medical Care Technical Support for applicable Field Service Bulletins. The spare parts manual for the model 2008K<sup>2</sup> and other information may be found on our web site at [www.fmcna.com](http://www.fmcna.com)*

*Indications for Use: The 2008K<sup>2</sup> hemodialysis machine is indicated for acute and chronic dialysis therapy.*

### **Conventions**

<b>Symbol</b>	<b>Description</b>
	<b>Warning!</b> A warning is a statement that identifies conditions or actions that could result in personal injury or loss of life. Warnings found in this manual outside of this section are designated with the warning symbol.
	<b>Shock Hazard:</b> A shock hazard warning refers to a risk of a possibly severe electrical shock due to improper use or handling of the equipment.
	<b>Caution:</b> A caution is a statement that identifies conditions or actions that could result in damage to the machine.
	<b>Note:</b> Notes are advisory comments or recommendations regarding practices or procedures.

# PREVENTIVE MAINTENANCE PROCEDURES

## TABLE OF CONTENTS

<b>1.0 INTRODUCTION .....</b>	<b>1</b>
1.1 TEST EQUIPMENT AND SUPPLIES NEEDED .....	1
1.2 OPERATING MODES .....	3
1.3 FRONT PANEL CONTROLS .....	4
1.4 MEASURING FLUID VOLUMES .....	7
<b>2.0 SIX (6) MONTH PREVENTIVE MAINTENANCE .....</b>	<b>8</b>
2.1 FILTERS .....	10
2.2 PRE-UF PUMP FILTER .....	10
2.3 UF PUMP CHECK VALVES .....	11
2.4 HIGH VOLTAGE AC CONNECTIONS .....	11
2.5 UF PUMP .....	12
2.6 CONDUCTIVITY .....	12
2.7 TEMPERATURE .....	13
2.8 ALARM OPERATION AND PRESSURE HOLDING TESTS .....	14
2.9 VERIFY PH .....	16
2.10 POWER FAILURE ALARM .....	16
2.11 FINAL CHECKS .....	17
<b>3.0 ANNUAL (4000 HOUR) PREVENTIVE MAINTENANCE .....</b>	<b>18</b>
3.1 FILTERS AND O-RINGS .....	18
3.2 PRE-UF PUMP FILTER .....	19
3.3 UF PUMP CHECK VALVES .....	19
3.4 DIAPHRAGM PUMPS .....	19
3.5 HEATER ELEMENT .....	20
3.6 HIGH VOLTAGE AC CONNECTIONS .....	20
3.7 DEAERATION MOTOR BRUSHES .....	21
3.8 INLET WATER PRESSURE REGULATOR .....	22
3.9 ONLINE CLEARANCE TEST (IF APPLICABLE) .....	23
3.10 DEAERATION AND LOADING PRESSURE .....	26
3.11 FLOW RELIEF PRESSURE .....	27
3.12 CONCENTRATE AND BICARB PUMPS .....	28
3.13 UF PUMP .....	28
3.14 CONDUCTIVITY .....	28
3.15 TEMPERATURE .....	28
3.16 VOLT HI LO DETECT .....	28
3.17 BLOOD LEAK AND DIMNESS .....	29
3.18 ARTERIAL, VENOUS AND TRANSMEMBRANE PRESSURE .....	30
3.19 DIALYSATE FLOW .....	33
3.20 HEPARIN PUMP .....	33
3.21 BLOOD PUMP .....	36
3.22 LEVEL DETECTOR .....	38
3.23 ALARM OPERATION AND PRESSURE HOLDING TESTS .....	40
3.24 VERIFY PH .....	40
3.25 RINSE CHECKS .....	41
3.26 BATTERY AND POWER FAILURE ALARM .....	42
3.27 BLOOD PRESSURE MODULE .....	43
3.28 FINAL CHECKS .....	46
<b>4.0 REBUILDING THE DIAPHRAGM PUMPS .....</b>	<b>47</b>
4.1 REBUILDING THE ULTRAFILTRATION PUMP .....	47
4.2 REBUILDING THE CONCENTRATE AND BICARBONATE PUMPS .....	50
4.3 TESTING CONCENTRATE AND BICARBONATE PUMPS .....	52
<b>PREVENTIVE MAINTENANCE CHECKLIST SIX (6) MONTH .....</b>	<b>55</b>
<b>PREVENTIVE MAINTENANCE CHECKLIST ANNUAL/4000 HOUR .....</b>	<b>57</b>

## General Warnings

---



**Warning!** Never perform maintenance when a patient is connected to the machine. If possible, remove the machine from the treatment area when it is being serviced. Label the machine to ensure it is not accidentally returned to clinical use before the service work is completed. Always fully test the machine when maintenance is completed. Confirm dialysate conductivity and pH level before returning the machine to clinical use.

---



**Shock Hazard:** Refer servicing to qualified personnel.

The electrical source must be 120 volts, 60 Hz, single phase. The outlet must be a three-conductor type with a hospital-grade receptacle and a ground fault interrupter. Test the polarity and ground integrity before installation and ensure it is maintained thereafter. Failure to do so may result in electrical shock to the operator or patient

---



**Warning!** Only Original Equipment Manufacturer (OEM) Fresenius Medical Care parts should be used in the repair or upgrade of the Fresenius Medical Care 2008K<sup>2</sup> Hemodialysis System. Although, parts may look similar to parts in various vendor catalogs or brick and mortar stores the 2008K<sup>2</sup> Hemodialysis System uses parts that have been specified and tested in accordance to ANSI/AAMI/ISO guidelines. The use of non-OEM parts will void your warranty and may cause patient harm.

---



**Note:** This document is written for the 2008K<sup>2</sup> Hemodialysis Systems using software versions 5.28 or later.

---

## 1.0 INTRODUCTION

Preventive Maintenance for the 2008K<sup>2</sup> Hemodialysis System is simple and straightforward. Maintenance is performed in only two intervals: six (6) months, and annually or after 4000 hours of operation. The maintenance procedures have been devised to require a minimum of time while ensuring that the machine is maintained in optimum operating condition.

Included in the Preventive Maintenance procedures are tests to verify normal machine operation. Should the machine fail to pass any of these tests, repair or re-calibrate as needed, then repeat the tests until the specifications are met before returning the machine to service.

Checklists are provided in the back of this manual to record the work done. Make copies of these checklists as needed. Your initials on the checklist certifies that each procedure has been completed and that the machine is performing according to the specifications given.

## 1.1 TEST EQUIPMENT AND SUPPLIES NEEDED

A number of small parts must be available to perform the Preventive Maintenance. Part number 190098 is a kit of the parts needed, except for the 9-Volt battery that must be replaced during the annual preventive maintenance. An NEDA 1604AC heavy-duty (alkaline type) battery is required. In addition, the following test equipment is needed:



**Warning!** Test equipment used must be maintained and/or calibrated per the test equipment manufacturer's requirements. In particular, the dialysate meter must meet the specifications listed below. Refer to the test equipment's operator's manual, or contact the manufacturer for calibration and maintenance requirements. Failure to properly maintain and calibrate test equipment could lead to improper calibration and/or failure of the device to meet its specifications.

---



**Warning!** Disinfect the machine internally and externally and check all pressure transducer protectors for contamination before working on the machine.

---

- 2008K<sup>2</sup> Calibrations Procedures (part number 508137).
- Test Kit (part number 150034), which contains two gauges with fittings and hoses for measuring loading pressure and deaeration pressure.
- Dialysate meter to measure dialysate pressure, temperature and conductivity at the ends of the dialysate lines. The meter must be capable of making pressure measurements from -250mmHg to +400mmHg with an accuracy of at least  $\pm 3$ mmHg. The temperature function of this meter must be accurate within 0.2°C from 20°C to 45°C and must be capable of measuring dialysate temperatures up to 85°C with an accuracy of at least  $\pm 4.0$ °C. The conductivity function of this meter must be accurate to within 0.1mS over a range of 12mS to 17mS at a temperature of 25°C.
- Stopwatch with a resolution to 0.01 second and an accuracy of 0.01% or better.
- Buret, 25ml capacity with 0.1ml graduations (part number 290104).
- Graduated cylinder: 1000ml capacity with a tolerance of 10.0ml at 1000ml or better.
- Syringe, 60cc capacity. Tolerance is not important; the syringe is not used for volume measurements.
- Tubing, 24" long (part number 545325-10). Use on the tip of the Buret.
- Resistor Plug Set for OLC Testing (part number 190168).

The following equipment is also required to test the blood pressure module:

- Test Device (part number 370090). The Test Device contains two air chambers with calibrated volumes.
- Mercury manometer or equivalent pressure meter accurate to within 1mmHg at pressures up to 330mmHg.



## 1.2 **OPERATING MODES**

The following preventive maintenance procedures contain instructions to place the 2008K<sup>2</sup> into Dialysis Mode and Service Mode.

To place the machine in Service Mode, turn the machine power On and wait for the message, **Press CONFIRM for Service Mode** to appear. Once it appears, press the [CONFIRM] key and the message will change to **Machine in Service Mode**. After the System Initializing process is complete, the machine will be in Service Mode.

If the [CONFIRM] key is not pressed when the **Press CONFIRM for Service Mode** message is on the screen, the screen will change and the message **Machine in Dialysis Mode** will appear. After the System Initializing process is complete, the machine will be in Dialysis Mode.

### 1.3 FRONT PANEL CONTROLS

The front panel consists of many areas. The following illustrates these areas:

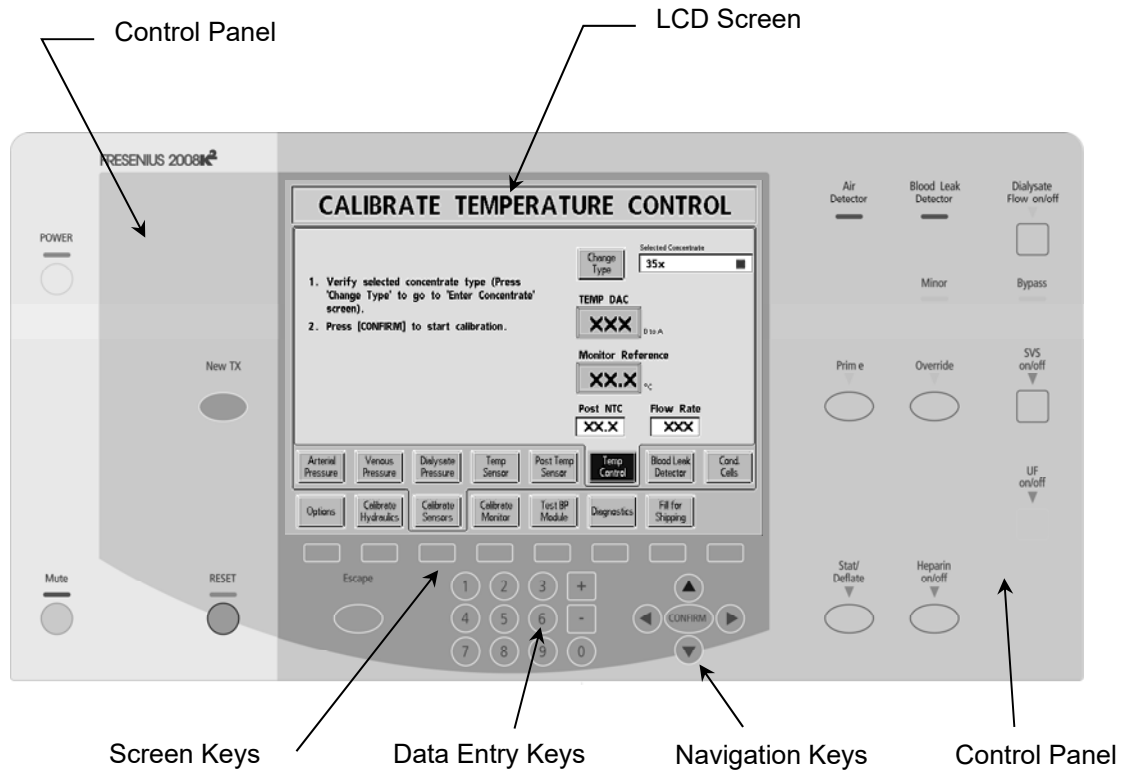

Figure 1 - 2008K<sup>2</sup> Front Panel

#### Control Panel Operation

Throughout the preventive maintenance procedures, whenever a control panel key is to be pressed, the appropriate key name is surrounded by square brackets as in the following example:

Press the [CONFIRM] key and the screen will change.

In this example, the [CONFIRM] key on the control panel should be pressed.

## Screen Operation

The screen is designed to display information and is used to enter data. The following describes the type of buttons and data boxes that will be encountered during the calibration process.

### Data Button

A yellow data button is used during calibration to enter a measured volume or value. When the yellow area of the data button is highlighted, it will change to a darker yellow. The data can be changed using the [+] and [-] data entry keys or the value can be entered using the number keys both on the control panel. Once the data is entered, press the [CONFIRM] key and the data button changes back to light yellow. The [Escape] key can be pressed when the data button is dark yellow to abort the data entry and return it to light yellow. The entered data does not get stored until the [CONFIRM] key is pressed. A gray data button means the button is not active.



### Screen Button (screen key)

The bottom row of blue screen buttons are selected by pressing the corresponding screen key directly below the screen button. By pressing a screen key, the screen will change to the selected screen directly without pressing the [CONFIRM] key. If data entry, option change, or menu selection is in process when a screen key is pressed, a message requiring the operator to press the [Escape] key or the [CONFIRM] key is displayed instead of changing screens.

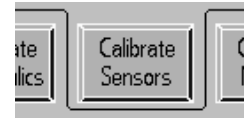

### Screen Button (screen change)

Some screen buttons that change screens are not part of the bottom row of the display. To use this type of screen button it must be highlighted first. Use the navigation keys ([▲], [▼], [◀], and [▶]) to highlight the desired screen button then press the [CONFIRM] key. The screen will change.



A screen button is not active if it is gray.

### Screen Button (menu selection)

Some screen buttons will display a menu of choices. To display the menu, use the navigation keys ([▲], [▼], [◀], and [▶]) to highlight the screen button and press the [CONFIRM] key. The menu will be displayed with the current selection highlighted. Use the [+] and [-] data entry keys to scroll the menu list and highlight a new selection. Once a new selection is highlighted, press the [CONFIRM] key and the selection is stored and the menu list disappears. If, after the menu is displayed, a new selection is not required, press the [Escape] key to keep the current selection and make the menu disappear.

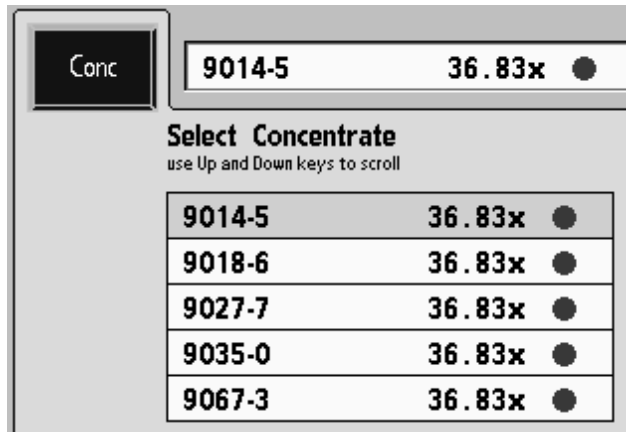

If a screen change is required while a menu is being displayed, the operator is prompted to press either the [Escape] key or the [CONFIRM] key.

### Data Box

This type of box shows selected data or data the machine is measuring. During the calibration process this type of box is used to verify a value or selection.

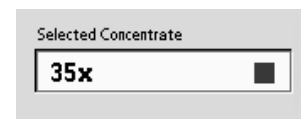

## 1.4 MEASURING FLUID VOLUMES

Several of the following procedures require measuring fluid volumes using graduated cylinders and laboratory burets. When making these measurements do the following:

- Make certain the container is clean and dry before collecting the fluid to be measured. Two drops of fluid are approximately 0.1ml, which is enough to affect the accuracy of critical measurements.
- Ensure that no items such as thermometers or tubing are allowed to come in contact with the fluid in the graduate. Such items will change the calibration of the graduate and affect the accuracy of measurements. Both the total volume indicated and the amount of fluid indicated by each increment on the graduated scale will be incorrect. For example, if a graduate is calibrated in 1ml increments, a piece of tubing in contact with the fluid will cause each increment to be *less* than 1ml, depending upon the total volume of the tubing that penetrates into the fluid.
- Surface tension causes the fluid to curve into a meniscus (See Figure 2). Measure the volume at the bottom of the meniscus curve as shown.

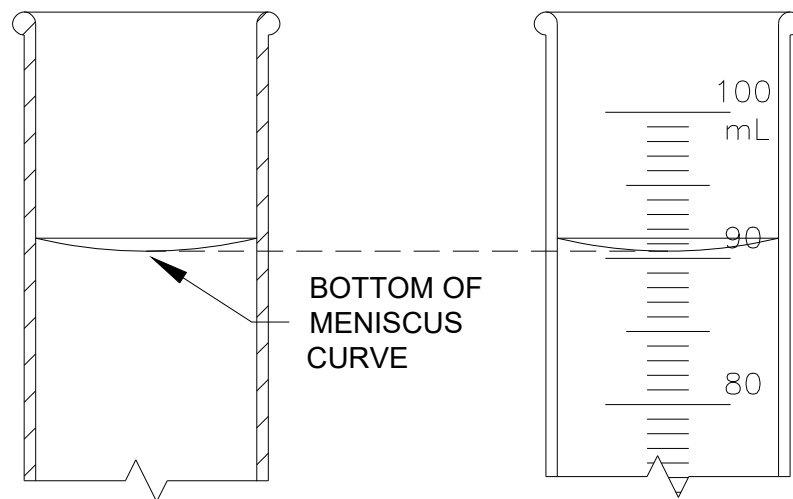

**Figure 2. Meniscus Curve.**

## 2.0

### **SIX (6) MONTH PREVENTIVE MAINTENANCE**

Perform the following Preventive Maintenance procedures every six (6) months of machine operation.

Make copies of the Six (6) Month Preventive Maintenance Checklist provided in the back of this manual and use them to record the maintenance done.



**Note:** When performing an Annual Preventive Maintenance do not perform the six (6) month procedures below first. Go directly to Section 3 and perform the annual procedures described there.

---

While performing the following procedures, check the floor of the hydraulic unit and all surfaces for moisture that might indicate a leak. Locate and correct any leaks detected. Clean the floor of the hydraulic unit so that future leaks will be readily apparent. Also, check all electrical connectors that can be reached to be sure they are fully seated and there is no strain on the electrical cables.

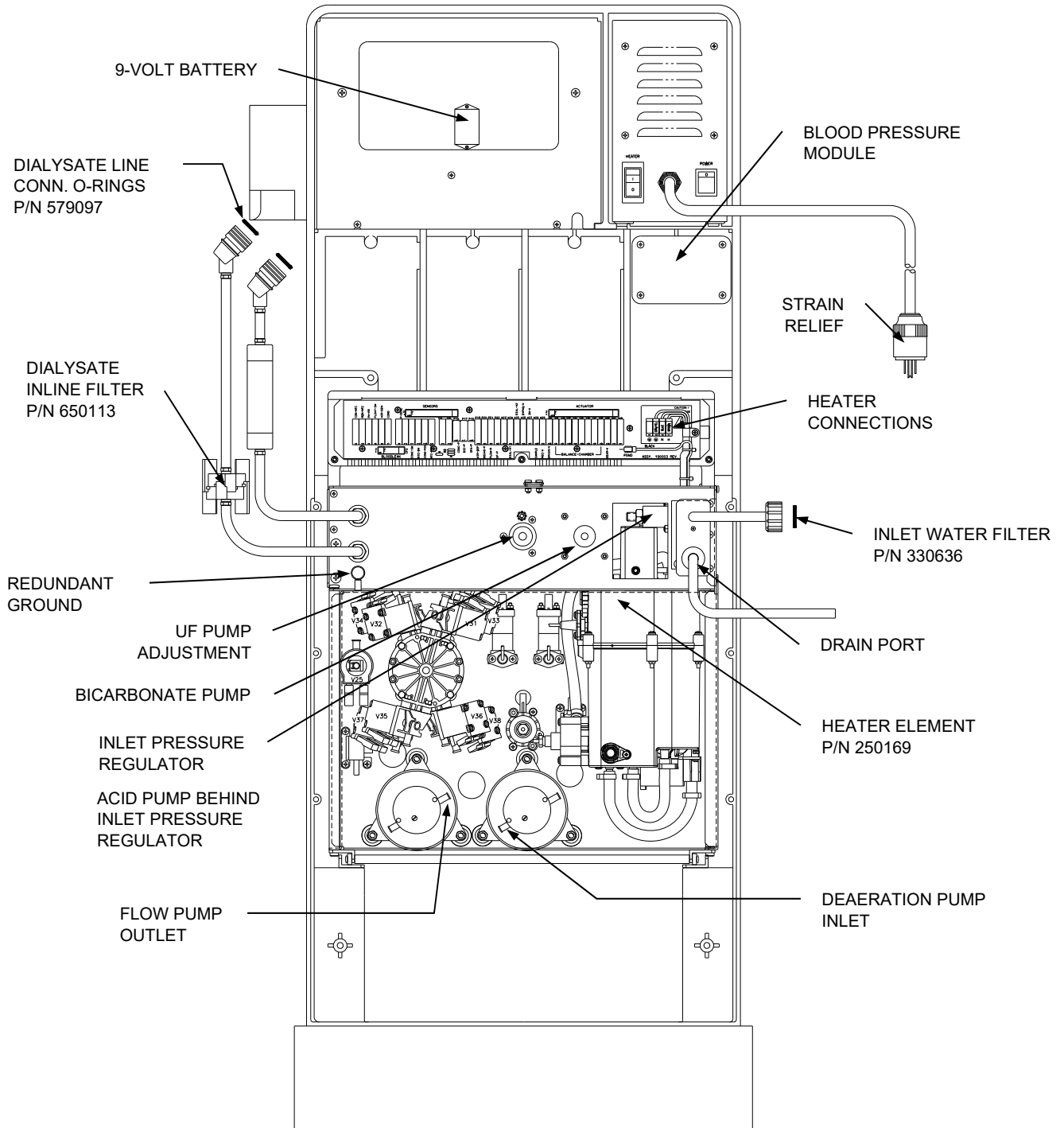

**Figure 3. 2008K<sup>2</sup> Hemodialysis System, Rear View.**

## 2.1 FILTERS

Clean filters as follows. Replace any filters that appear damaged or corroded.

1. Inlet Water Filter in the inlet connector of the water supply (See Figure 3, pg. 9).



**Warning!** After cleaning or replacing the inlet filter screen, disinfect the water inlet line as described in the Operator's manual and in accordance with your Unit Policy.

---

2. Filters in the Concentrate and Bicarbonate Connectors (See Figure 4.).

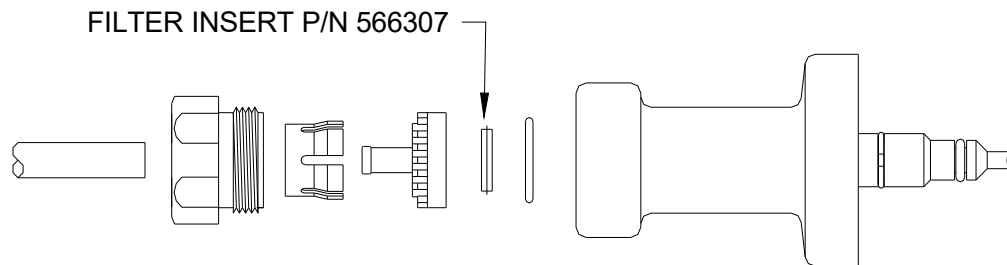

**Figure 4. Concentrate and Bicarbonate Connector Assemblies.**

3. Clean the Dialysate Inline filter (See Figure 3, pg. 9).

## 2.2 PRE-UF PUMP FILTER

Inspect the Pre-UF Pump filter for leaks or distortion. Replace the Pre-UF Pump Filter if leakage or distortion is found.



**Caution:** Do not attempt to disassemble the Pre-UF Pump Filter. If not properly reassembled, the Pre-UF Pump filter may leak. A leak in the hydraulic system at this location may affect the operation of the machine or cause fluid loss from the patient.

---



## 2.3 UF PUMP CHECK VALVES

---



**Caution:** If a check valve is replaced, ensure it is oriented correctly to allow fluid flow in the proper direction.

---

Inspect the UF pump Output check valves (one at the UF pump output and the other downstream at the UF Sample Port). Replace any that show signs of wear, damage or leaking.

## 2.4 HIGH VOLTAGE AC CONNECTIONS

---



**Shock Hazard:** Dangerous high voltage is present at the connections accessed in this procedure when the machine is operating. Ensure the machine's power plug is disconnected from the wall outlet before proceeding.

---

1. Remove power from the machine then check and tighten the 8-pin heater connections next to the distribution board (See Figure 3, pg. 9). Check heater block AC connections for signs of arcing or melting.
2. If applicable, inspect the power plug for loose or frayed wires. Ensure the strain relief is securely fastened.
3. Inspect the entire length of the power cord (from plug to strain relief) for nicks or cuts in the insulation and replace if necessary (part number 150425).
4. Confirm that the strain relief is tightly secured to the power supply chassis.
5. At the strain relief, locate the black, white and green wires from the power cord (inside the power supply chassis). Follow the black and white wires to the main power switch. Attached to the main power switch are four (4) wires (2 black and 2 white). Look for loose connections, cracked insulation, and signs of overheating, such as discolored or melted insulation. Replace wires with power supply wire kit (part number 190411).
6. Inspect the main power switch and verify that its operation is smooth (no grinding or sticky operation) and that the wires are not crossed.



---

**Shock Hazard:** Do not operate the machine if the resistance is greater than 0.2 ohm. A shock hazard to operators and patients could exist.

---

7. With a digital multimeter, measure the resistance between the round (ground) pin on the power plug and the redundant ground terminal on the machine (See Figure 3, pg. 9). Verify that the resistance is less than or equal to 0.2 ohm. If the value is above 0.2 ohm, measure the internal resistance of your meter by shorting the leads together, then subtract this value from the resistance measured between the power plug ground pin and the redundant ground terminal on the machine to obtain the true ground resistance.
8. Record the measured value on either the Six (6) Month Preventive Maintenance Checklist or the Annual/4000 Hour Preventive Maintenance Checklist depending upon which is being performed.
9. Perform the electrical safety checks required by local codes, facility procedure and the Joint Commission on Accreditation of Healthcare Organizations.

## **2.5 UF PUMP**

Calibrate the UF Pump Volume (Refer to the 2008K<sup>2</sup> Calibration Procedures – part number 508137.)

Record the measured value on the Six (6) Month Preventive Maintenance Checklist.

## **2.6 CONDUCTIVITY**

Verify that the dialysate conductivity measured by the internal cell in the machine agrees with an external meter within 0.1mS/cm as follows:

1. Connect an external conductivity meter to the dialysate lines.
2. With the machine in Dialysis Mode and flow ON, compare the value shown on the external meter with the conductivity shown on the Display screen. They must be within 0.1mS/cm of each other.
3. Record the measured value on either the Six (6) Month Preventive Maintenance Checklist or the Annual/4000 Hour Preventive Maintenance Checklist depending upon which is being performed.

## 2.7 **TEMPERATURE**

Verify that the actual dialysate temperature measured by an external meter agrees with the display screen within 0.3°C at 37°C and 39°C as follows:

1. Connect the dialysate lines to an external meter.
2. Place the machine in Dialysis Mode with concentrate in the system. Clear any alarms.
3. Select<sup>1</sup> the **Temperature** button. The button label will change to **Temp. Setting**. The value now displayed on this button is the temperature set point. Adjust the temperature set point to exactly 37.0 then press the **[CONFIRM]** key. The button will change back and now reads the actual temperature of the dialysate again. Wait until this value stabilizes. It will settle very close to the value set, depending upon inlet water temperature and other conditions.
4. After the temperature of the dialysate stabilizes, compare the temperature shown on the **Temperature** button with the temperature shown on the external meter connected to the dialysate lines. The two readings must be within 0.3°C of each other.
5. Record the measured value on either the Six (6) Month Preventive Maintenance Checklist or the Annual/4000 Hour Preventive Maintenance Checklist depending upon which is being performed.
6. Repeat steps 3 and 4 with the temperature set to 39.0°C. Verify that the actual temperature reported on the front panel display screen and the external meter are within 0.3°C of each other after the temperatures stabilize again.
7. Record the measured values on either the Six (6) Month Preventive Maintenance Checklist or the Annual/4000 Hour Preventive Maintenance Checklist depending upon which is being performed.

<sup>1</sup> Refer to Section 1.3 on the use of screen buttons.

## 2.8 **ALARM OPERATION AND PRESSURE HOLDING TESTS**

Verify the automatic alarms produce the responses shown in Table 1 and the machine passes the automatic pressure holding test as follows:

1. Place the dialysate lines in the shunt and close the door.



**Warning!** The use of a “test drip chamber” or “dummy drip chamber” must never be used on the treatment floor. It must only be used in a controlled technical environment.

---

2. Place a venous chamber filled with water in the holder on the level detector module.
3. Place the machine in Dialysis mode and start the blood pump. Clear all blood and water alarms.
4. Select<sup>1</sup> the **Test & Options** screen key. On this screen select<sup>1</sup> the **Both Tests** button. Press the [CONFIRM] key to start.
5. Observe the machine stepping through the following alarm tests and ensure that each alarm produces all of the responses shown in Table 1.

<sup>1</sup> Refer to Section 1.3 on the use of screen buttons.

**Table 1. Alarm Tests.**

ALARM TEST	RESPONSE
Air Detector	<ol style="list-style-type: none"> <li>1. Red visual alarm</li> <li>2. Venous clamp closes</li> <li>3. Blood pump stops</li> </ol>
Blood Leak	<ol style="list-style-type: none"> <li>1. Red visual alarm</li> <li>2. Venous clamp closes</li> <li>3. Blood pump stops</li> </ol>
Arterial Pressure	<ol style="list-style-type: none"> <li>1. Red visual alarm</li> <li>2. Venous clamp closes</li> <li>3. Blood pump stops</li> </ol>
Venous Pressure	<ol style="list-style-type: none"> <li>1. Red visual alarm</li> <li>2. Venous clamp closes</li> <li>3. Blood pump stops</li> </ol>
TMP	<ol style="list-style-type: none"> <li>1. Red visual alarm</li> <li>2. Venous clamp closes</li> <li>3. Blood pump stops</li> </ol>
9-Volt Battery	<p>Passes if battery voltage is greater than 7.0 volts under a load of 22Ω.</p>
Optical Detector	<ol style="list-style-type: none"> <li>1. Lower venous alarm limit rises to 10mmHg causing a venous pressure alarm</li> <li>2. Venous clamp closes</li> <li>3. Blood pump stops</li> </ol>
Temperature	<ol style="list-style-type: none"> <li>1. Red visual alarm</li> <li>2. Yellow visual bypass</li> <li>3. Machine in Bypass mode (no flow through the dialysate flow indicator).</li> </ol>
Conductivity	<ol style="list-style-type: none"> <li>1. Red visual alarm</li> <li>2. Yellow visual bypass</li> <li>3. Machine in Bypass mode (no flow through the dialysate flow indicator).</li> </ol>

6. When the tests shown in Table 1 are complete, the machine conducts a pressure holding test. When the test ends verify that the display screen reports **TEST COMPLETE**, indicating that all the tests were passed successfully. Press the [RESET] key.
7. Test the UF pump integrity as follows:
  - Pull the hydraulics out and remove the output tube from the UF pump.
  - Install a 24” tube (part number 545325-10) to the empty output port. Route this tubing out the back of the machine so that it will not be kinked or pinched when the hydraulics is closed. Close the hydraulics and place the other end of tube into a collection container.
  - Conduct steps 1-6 again.
    - If the pressure holding test fails, refer to Section 4.1.
    - If the pressure holding test passes, disconnect the 24” tube and reconnect the original output tube to the UF pump.
8. Test the audible alarm as follows:
  - Place a piece of opaque paper inside the housing of the optical detector to simulate a line containing blood. Close the door of the optical detector.
  - Open the shunt door. Verify that the machine responds with an audible alarm. Press the [Mute] key and verify that the Mute lamp lights, and the audible tone stops.

## **2.9      VERIFY pH**

1. Place the machine into dialysis mode and allow it 10 minutes to stabilize.
2. Use a pH test strip (part number 335130-01 or equivalent) to verify the dialysate fluid is between the ANSI/AAMI RD52 standard of 6.9 and 7.6.
3. Record the measured value on the Six (6) Month Preventive Maintenance Checklist.

## **2.10     POWER FAILURE ALARM**

Test the Power Failure alarm by turning the main power switch off on the back of the power supply with the machine powered on. Verify that the audible alarm sounds. If no audible alarm occurs, check/replace the 9-Volt battery.

## 2.11 **FINAL CHECKS**

Before returning the machine to clinical use after successful completion of all of the Preventive Maintenance procedures listed above, complete the following:

- Verify that the machine label with serial number is in place, usually on the back of the cabinet near the Monitor Control Unit or above the quick connectors of the open shunt door assembly. Record this serial number on the Preventive Maintenance Checklist form.
- Verify that no dialysate spills or leaks are visible in the hydraulics or on the bottom of the cabinet. Clean and dry any spills found and correct the source.
- Verify that all cables are properly routed to prevent pinching or chaffing.
- Verify that all covers are replaced and that all cover screws and mounting hardware has been replaced.



**Caution:** Reliable operation of the machine requires that all screws and covers be properly installed. Ensure that all screws and covers are in place before returning the machine to clinical use.

---

- Clean the exterior surfaces of the machine and remove all traces of dirt, oil or other contaminants.



**Caution:** Do not use a cleaner containing Dimethyl Benzylammonium Chloride. This ingredient will damage many plastic surfaces. Certain brands of cleaners specifically marketed to clinics and hospitals contain this ingredient. Check the contents of any unknown cleaner before using it.

---

### 3.0 **ANNUAL (4000 HOUR) PREVENTIVE MAINTENANCE**

Perform the following Preventive Maintenance procedures every 12 months or 4000 hours of machine operation, whichever comes first. Perform the procedures in the order given below to complete the Annual Preventive Maintenance.

Make copies of the Annual Preventive Maintenance Checklist provided at the back of this manual and use them to record the maintenance done.



**Note:** When performing an Annual Preventive Maintenance do not perform the six (6) month procedures first. The annual procedures will refer back to a Section 2 six (6) month procedure when necessary.

### 3.1 **FILTERS AND O-RINGS**

Clean filters and replace O-rings as follows. Replace any filters that appear damaged or corroded.

1. Inlet Water Filter in the inlet connector of the water supply (See Figure 3, pg. 9).



**Warning!** After cleaning or replacing the inlet filter screen, disinfect the water inlet line as described in the Operator's manual and in accordance with your Unit Policy.



**Warning!** Excessive silicone-gel O-ring lubricant can damage the hydraulic pressure transducers (P-DIAL and CFS). Only apply a minimal thin layer of O-ring lubricant when needed.

2. Filters and O-rings in the Concentrate and Bicarbonate Connectors (See Figure 5). Replace all three O-rings in each connector.

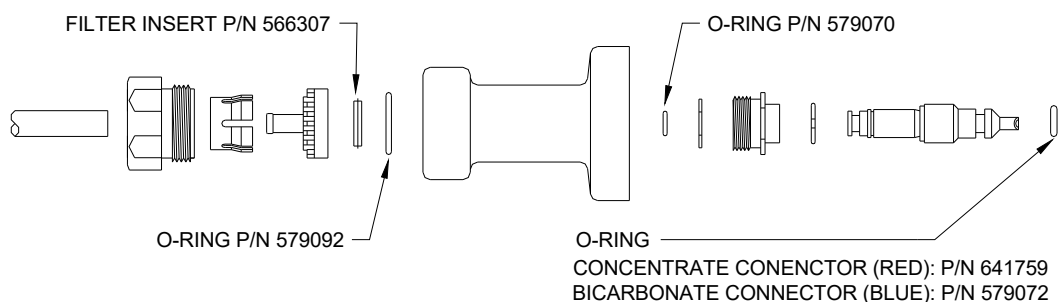

**Figure 5. Concentrate and Bicarbonate Connector Assemblies.**

3. Clean the Dialysate Inline filter (See Figure 3, pg. 9).
4. Replace the O-rings in the Dialysate Line Connectors (See Figure 3, pg. 9).



### 3.2 **PRE-UF PUMP FILTER**

Replace the Pre-UF Pump Filter (part number 672574).



**Caution:** Do not attempt to disassemble the Pre-UF Pump Filter. If not properly reassembled, the Pre-UF Pump filter may leak. A leak in the hydraulic system at this location may affect the operation of the machine or cause fluid loss from the patient.

---

### 3.3 **UF PUMP CHECK VALVES**



**Caution:** Ensure each check valve is oriented correctly to allow fluid flow in the proper direction.

---

Replace the UF Pump Output check valves. There are two check valves at the UF pump output. One is at the UF pump itself. The other is downstream at the UF Sample Port.

### 3.4 **DIAPHRAGM PUMPS**

Rebuild the UF, Bicarbonate and Concentrate diaphragm pumps as described in Sections 4.1 and 4.2.

### 3.5

#### HEATER ELEMENT

---



**Shock Hazard:** Dangerous high voltage is present at these connections when the machine is operating. Ensure the machine is disconnected from the wall outlet.

---



**Caution:** The heater element is hot enough to inflict serious injury if it is touched while power is applied or shortly after power is removed. Ensure the machine is disconnected from the wall outlet.

---

1. Remove the rear access panels and distribution board cover so that the wires of the heater are accessible.



**Note:** If the heater element is replaced, replace the heater O-ring as well (part number F40003854).

---

2. Remove the heater element from the hydrochamber on the machine (See Figure 3, pg. 9). Inspect the heater element for signs of corrosion. If corrosion exists, replace the heater element.
3. Attach one lead of the voltmeter to the ground (yellow / green wire) and the other lead to the brown or blue wire. Measure the resistance. Resistance should be “ OL “ or greater than 19.9 meg-ohms. If this is not the case, replace the heater element.
4. After completing this check, reinstall the heater element and O-ring.

### 3.6

#### HIGH VOLTAGE AC CONNECTIONS

Perform the Six (6) Month Preventive Maintenance procedures in Section 2.4.

### 3.7 **DEAERATION MOTOR BRUSHES**

Replace the deaeration motor brushes every 8000 hours using the following steps:

1. Remove the complete deaeration motor/pump assembly from the machine.
2. Using a marker, make marks on the motor housing and motor cap as illustrated below. These marks will ensure the correct alignment when reassembling the motor case.

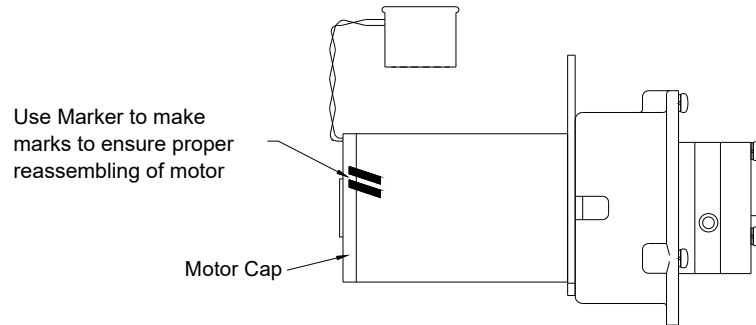

**Figure 6. Deaeration Motor/Pump Assembly with marks.**

3. Using a T-25 Torx screwdriver, remove the two screws holding the motor cap to the motor housing.
4. Remove the motor cap to gain access to the motor brushes. Replace the motor brushes.
5. Reassemble the motor, aligning the marks.
6. While holding the pieces together, install and tighten the two T-25 screws.



**Note:** If the motor case and motor cap are not installed using the marks, the motor will run in reverse and flow errors will result.

---

### 3.8 INLET WATER PRESSURE REGULATOR

Verify that the regulator provides the proper water pressure as follows:

1. Shut off the water supply to the machine.
2. Install a gauge with a T-fitting to monitor the pressure at the outlet side of the Inlet Pressure Regulator (See Figure 3, pg. 9).



---

**Caution:** Use tie wraps or tubing clamps to secure the connections. The water pressure may be sufficient to blow the lines off the fittings if they are not secured.

---

3. Turn the water supply to the machine ON.
4. With the dialysate lines in the shunt, select<sup>1</sup> Dialysis Mode. The pressure gauge will cycle between two readings as the water inlet valve opens and closes.
5. Allow the water inlet valve to open and close for approximately 30 seconds to clear any air.
6. Once the air is gone, verify the pressure gauge reads between 18 and 20psi when the pressure is at its highest value, and reads greater than 8psi when the pressure is at its lowest value.



---

**Note:** Readings below 8psi at the lowest level indicates inadequate inlet water flow into the machine. This may be caused by a dirty inlet filter screen or problems with the treated water supply.

---

7. Record the measured value on the Annual/4000 Hour Preventive Maintenance Checklist.
8. Turn the dialysate flow off and the pressure gauge will stop cycling and will show only a single pressure.
9. Note this single pressure reading on the pressure gauge.
10. After 15 minutes, check for any pressure increase on the pressure gauge.
11. If the pressure reading on the pressure gauge increases, the Inlet Pressure Regulator is leaking internally and needs to be rebuilt or replaced

	Part Number
Complete Inlet Pressure Regulator:	565048
Rebuild Kit for the Inlet Pressure Regulator:	190934

12. If the Inlet Pressure Regulator passes the internal leakage test, turn the machine OFF, turn OFF the water supply, remove the gauge and reconnect the tubing using clamps to prevent leaks.
13. Turn the treated water supply source ON, turn the machine ON and select<sup>1</sup> Dialysis Mode. Start dialysate flow and inspect all hoses and connections. Ensure that there are no leaks.

<sup>1</sup> Refer to Section 1.3 on the use of screen buttons.

### 3.9 ONLINE CLEARANCE TEST (IF APPLICABLE)

If the machine is equipped with Online Clearance (OLC), conduct the following test:

#### OLC Self-Test

1. With stable temperature and conductivity, start an OLC Self-Test by selecting<sup>1</sup> the OLC Self-Test screen button on the Kt/V screen.



**Note:** Switch to the debug screens by pressing and holding the [+ ] and [- ] keys at the same time for approximately 1 sec. The main display will change indicating that the machine is in debug mode.

---

2. When the OLC Self-Test is complete, go to debug screen #5 and confirm that 0 Test is in the range  $\pm 25$ .



**Note:** If 0 Test is out of range, the OLC Self-Test will fail. If this happens, conduct temperature (PRE & POST) and conductivity calibrations, then conduct OLC Self-Test again.

---

#### OLC Self-Test Troubleshooting

If the OLC Self-Test continues to fail after conducting the temperature (PRE & POST) and the conductivity calibrations, conduct the following troubleshooting steps:

1. Turn the machine ON and allow the machine to run in Dialysis Mode at 500ml/min flow rate for approximately 10 minutes. This allows the machine to come up to temperature and conductivity.
2. Once the machine is warmed up, remove X3 (MON-NTC) and X7 (COND) from the distribution board.
3. Using the Resistor Plug Set for OLC Testing (part number 190168), plug the 6.04K $\Omega$  plug into X3 (MON-NTC) and the 274 $\Omega$  plug into X7 (COND) on the distribution board.



**Note:** Due to the resistor placement inside the OLC test plugs, the orientation of the plug when inserted onto the distribution board is irrelevant.

---

<sup>1</sup> Refer to Section 1.3 on the use of screen buttons.

4. Switch to the debug screens by pressing and holding the **[+]** and **[-]** data entry keys at the same time for approximately 1 sec. The main display will change indicating that the machine is in debug mode.
5. Use the **[+]** or **[-]** data entry keys to go to debug screen #5.
6. On debug screen #5, locate TPRE and observe its value for 1 minute. During this time, record the highest and lowest values observed in the table below.

	Highest Value	Lowest Value	Difference
TPRE	-		=

7. Calculate the difference between the highest and lowest TPRE value and record it in the table above.
8. Verify that the difference for TPRE  $\leq 2$ . If the difference for TPRE  $> 2$ , then possible causes are sensor board, motor noise, or -12V problems.
9. Again on debug screen #5, locate CPRE and observe its value for 1 minute. During this time record the highest and lowest values observed in the table below.

	Highest Value	Lowest Value	Difference
CPRE	-		=

10. Calculate the difference between the highest and lowest CPRE value and record it in the table above.
11. Verify that the difference for CPRE  $\leq 8$ . If the difference for CPRE  $> 8$ , then possible causes are sensor board, motor noise, or -12V problems.
12. Remove the 6.04K $\Omega$  and 274 $\Omega$  plug from the distribution board and replace the original connectors.
13. Remove X44 (NTC-POST) and X13 (COND-POS) from the distribution board.
14. Using the Resistor Plug Set for OLC Testing (part number 190168), plug the 6.04K $\Omega$  plug into X44 (NTC-POST) and the 274 $\Omega$  plug into X13 (COND-POS) on the distribution board.

- On debug screen #5, locate TPOS and observe its value for 1 minute. During this time record the highest and lowest values observed in the table below.

	Highest Value	Lowest Value	Difference
TPOS	-		=

- Calculate the difference between the highest and lowest TPOS value and record it in the table above.
- Verify that the difference for TPOS  $\leq 2$ . If the difference for TPOS  $> 2$ , then possible causes are sensor board, motor noise, or -12V problems.
- Again on debug screen #5, locate CPOS and observe its value for 1 minute. During this time record the highest and lowest values observed in the table below.

	Highest Value	Lowest Value	Difference
CPOS	-		=

- Calculate the difference between the highest and lowest CPOS value and record it in the table above.
- Verify that the difference for CPOS  $\leq 8$ . If the difference for CPOS  $> 8$ , then possible causes are sensor board, motor noise, or -12V problems.



---

**Note:** In the following step, conduct the test for the dialysate flow ON to OFF transition.

---

- With the 6.04K $\Omega$  plug on X44 (NTC-POST) and the 274 $\Omega$  plug on X13 (COND-POS) of the distribution board, verify that CPOS does not change more than 10 increments when the dialysate flow is turned OFF.
- Remove the 6.04K $\Omega$  and 274 $\Omega$  plug from the distribution board and replace the original connectors.
- With stable temperature and conductivity, start an OLC Self Test by selecting<sup>1</sup> the OLC Self-Test screen button on the Kt/V screen.
- When the OLC Self Test is complete, go to debug screen #5 and confirm that 0 Test is in the range  $\pm 25$ .

<sup>1</sup> Refer to Section 1.3 on the use of screen buttons.

### 3.10 DEAERATION AND LOADING PRESSURE

Verify that the deaeration pressure is between -24 and -25 inHg and the loading pressure is between 18 and 20psi (between 23 and 25psi if a DIASAFE® Plus filter system is installed) as follows:

1. With dialysate flow OFF, install a gauge with a T-fitting to monitor the pressure on the inlet (suction) side of the deaeration pump (See Figure 3, pg. 9).
2. Connect a gauge equipped with a yellow connector into the red ACETATE/ACID port.
3. In Dialysis Mode, turn dialysate flow ON and verify that the gauge on the deaeration pump indicates between -24 and -25 inHg. The needle will be vibrating somewhat. Verify that it does not go higher than -24 inHg or lower than -25 Hg. Verify that the gauge in the ACETATE/ACID port indicates between 18 and 20psi (between 23 and 25psi if a DIASAFE® Plus filter system is installed).
4. Record the measured values on the Annual/4000 Hour Preventive Maintenance Checklist.



**Note:** When the machine is at a different elevation above sea level, it may be difficult or impossible to achieve -24inHg. The following table will help in determining the appropriate deaeration pressure calibration point at different elevations:

**Table 2**

<b>Elevation</b>	<b>Approx. atmospheric pressure</b>	<b>Minimum target deaeration pressure relative to atmospheric pressure</b>
<b>feet</b>	<b>mmHg</b>	<b>inches of Hg</b>
0	760	-24.0
1000	728	-23.0
2000	697	-22.0
3000	667	-21.0
4000	639	-20.0
5000	612	-19.0
6000	585	-18.5
7000	561	-17.5
8000	537	-16.9
9000	514	-16.2
10000	492	-15.5



### 3.11 FLOW RELIEF PRESSURE

Verify that the flow relief pressure is between 29 and 30psi (between 35 and 36psi if a DIASAFE® Plus filter system is installed) as follows:

1. Turn the machine on in Service mode. From the Calibrate Hydraulics screen, select<sup>1</sup> the Flow Pressure screen button. The screen will change to the following:

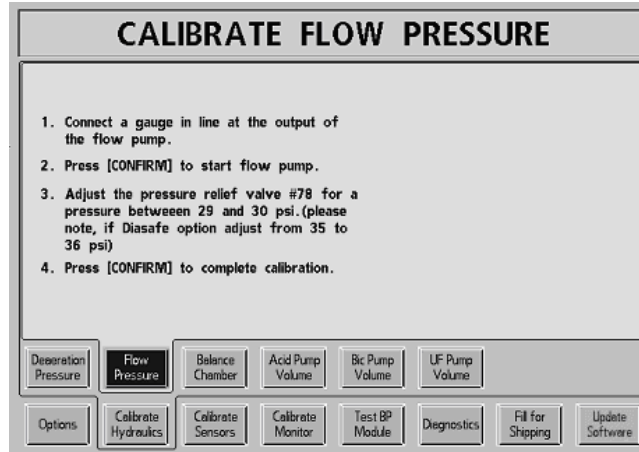

2. Connect a gauge in line at the **output** of the flow pump (See Figure 3, pg. 9).



---

**Note:** The output side of the flow pump is the side with the white reinforced jacket over the line. The input side has clear plastic line.

---

3. Press the [CONFIRM] key to start the flow pump.
4. Verify the gauge indicates a pressure between 29 and 30psi (between 35 and 36psi if a DIASAFE® Plus filter system is installed).
5. Record the measured value on the Annual/4000 Hour Preventive Maintenance Checklist.

<sup>1</sup> Refer to Section 1.3 on the use of screen buttons.

### 3.12 **CONCENTRATE AND BICARB PUMPS**

Test the Concentrate and Bicarbonate diaphragm pumps as described in Section 4.3.

### 3.13 **UF PUMP**

Calibrate the UF Pump Volume (Refer to the 2008K<sup>2</sup> Calibration Procedures – part number 508137.).

Record the measured value on the Annual/4000 Hour Preventive Maintenance Checklist.

### 3.14 **CONDUCTIVITY**

Verify that the dialysate conductivity measured by the internal cell in the machine agrees with an external meter within 0.1mS/cm as described in Section 2.6.

### 3.15 **TEMPERATURE**

Verify that the dialysate temperature shown on the front panel Display screen agrees with an external meter within 0.3°C at 37°C and 39°C as described in Section 2.7.

### 3.16 **VOLT HI LO DETECT**

Verify that the 5-volt supply is operating within 0.2 volts as reported on the debug screen as follows:

1. Switch to the debug screens by pressing and holding the **[+]** and **[-]** data entry keys at the same time for approximately 1 sec. The main display will change indicating that the machine is in debug mode.
2. Use the **[+]** or **[-]** data entry keys to go to debug screen #4.
3. Locate the 5V value on the display screen. This value must be between 4.8V and 5.2V.



**Note:** If the 5V value is not within limits, the problem is most likely the 12volt supply out of tolerance. Perform the Volt Hi Lo Detect calibration procedure. Refer to the 2008K<sup>2</sup> Calibration Procedures – part number 508137.

---

4. Record the measured value on the Annual/4000 Hour Preventive Maintenance Checklist.

### 3.17 **BLOOD LEAK AND DIMNESS**

Verify that the blood leak level is between 4.5 and 5.2 volts and the blood dimness level is within  $5.0 \pm 1.0$  volts as follows:

1. Switch to the debug screens by pressing and holding the **[+]** and **[-]** data entry keys at the same time for approximately 1 sec. The main display will change indicating that the machine is in debug mode.
2. Use the **[+]** or **[-]** data entry keys to go to debug screen #4.
3. Locate the **LEAK** value on the display screen. This value must be between 4.5V and 5.2V.
4. Locate the **DIMN** value on the display screen. This value must be between 4.0V and 6.0V.



**Note:** If these values are outside the limits given, perform a bleach rinse to clean the glass detector tube inside the machine before considering other repairs.

---

5. Record the measured value on the Annual/4000 Hour Preventive Maintenance Checklist.

**ARTERIAL, VENOUS AND TRANSMEMBRANE PRESSURE****ARTERIAL PRESSURE**

1. Inspect the internal pressure transducer protector for contamination. If contamination is found, replace the pressure transducer protector (part number M30971) and remove and disinfect the pressure port with 1:100 bleach for a minimum of 15 minutes.
2. Open the arterial transducer port **P<sub>ART</sub>**. On the blood pump module to air (atmospheric pressure). Verify that the Arterial Pressure bargraph indicates 0.
3. Attach a syringe and a calibrated pressure gauge to the **P<sub>ART</sub>** Port using a T-fitting.
4. Push the syringe in to show a pressure of 200mmHg on the external gauge. Verify that the Arterial Pressure bargraph indicates 200.
5. Switch to the debug screens by pressing and holding the **[+]** or **[-]** data keys at the same time for approximately 1 sec. The main display will change indicating that the machine is in debug mode.
6. Use the **[+]** or **[-]** data keys to go to debug screen #1 and locate the ART value.
7. Increase the pressure to a range of 310 – 315mmHg. Clamp off the tubing at the **P<sub>ART</sub>** Port and monitor the debug ART value for 30 seconds. The maximum allowable leakage is 2mmHg in 30 seconds.

## VENOUS PRESSURE

1. Inspect the internal pressure transducer protector for contamination. If contamination is found, replace the pressure transducer protector (part number M30971) and remove and disinfect the pressure port with 1:100 bleach for a minimum of 15 minutes.
2. Open the venous transducer port **P<sub>VEN</sub>**. On the level detector module to air (atmospheric pressure). Verify that the Venous Pressure bargraph indicates 0.
3. Attach a syringe and a calibrated pressure gauge to the **P<sub>VEN</sub>** Port using a T-fitting.
4. Push the syringe plunger in to show 400mmHg on the external pressure gauge. Verify that the Venous Pressure bargraph indicates 400.
5. Switch to the debug screens by pressing and holding the **[+]** or **[-]** data keys at the same time for approximately 1 sec. The main display will change indicating that the machine is in debug mode.
6. Use the **[+]** or **[-]** data keys to go to debug screen #1 and locate the VEN value.
7. Decrease the pressure to a range of 310 – 315mmHg. Clamp off the tubing at the **P<sub>VEN</sub>** Port and monitor the debug VEN value for 30 seconds. The maximum allowable leakage is 2mmHg in 30 seconds.

## TRANSMEMBRANE PRESSURE

1. With dialysate flow ON, ensure the dialysate lines are full of fluid and no air is visible passing through the flow indicator.
2. Hang a four-way connector to the I.V. pole at normal dialyzer height.
3. Set dialysate flow to 500ml/min, then press the [CONFIRM] key.
4. Open the arterial (**P**<sub>ART.</sub>) and venous (**P**<sub>VEN.</sub>) transducer ports to air (atmospheric pressure).
5. Turn the blood pump off.
6. Turn dialysate flow OFF, remove the dialysate lines from the shunt and attach them to the connector. Close the shunt door.



**Note:** Filling the lines before removing them from the shunt will avoid wetting the pressure gauge transducer during the test.

---

7. Connect a 30cc syringe to one of the four-way connector outlets and a pressure gauge to the remaining outlet.
8. Switch to the debug screens by pressing and holding the [**+**] and [**-**] data entry keys at the same time for approximately 1 sec. The main display will change indicating that the machine is in debug mode.
9. Use the [**+**] or [**-**] data entry keys to go to debug screen #1.
10. Use the syringe to set the pressure on the external gauge to 0mmHg. Calculate the dialysate pressure measured by the machine as follows:
  - Note the value shown for **TMP** on the display screen.
  - Subtract the value shown for **VEN** on the display screen.
11. Verify that the calculated value is between +20 and -10mmHg.
12. Use the syringe to create a pressure of -250mmHg on the pressure gauge.
13. Calculate the dialysate pressure measured by the machine again as described in step 10. Verify that the calculated value is between -230 and -260mmHg.

### 3.19 DIALYSATE FLOW

Verify the dialysate flow is within  $\pm 3\%$  of the stated rate at 500ml/min as follows:



**Note:** All flow rates are controlled by the software. Testing the rate at 500ml/min verifies the accuracy of all rates.

---

1. In Dialysis Mode, turn the dialysate flow ON at 500ml/min. Verify that the UF pump is OFF and the machine is out of bypass. Allow the dialysate flow to run for 2 minutes, minimum, before continuing.



**Note:** Do not collect the spent dialysate from the drain hose in the next step. The accuracy of the collection will be affected if not collected directly from the drain port with the drain hose removed.

---

2. Collect spent dialysate from the drain port on the back of the machine (See Figure 3, pg. 9) for exactly 1 minute. Verify that the amount collected is between 485 and 515ml.
3. Record the measured value on the Annual/4000 Hour Preventive Maintenance Checklist.

### 3.20 HEPARIN PUMP

If the machine is equipped with a heparin pump module, clean and test the pump as follows:

1. Remove the heparin pump module from the machine and wipe the lower edge of the module and the heparin pump cabinet opening to remove any residual disinfecting agent.
2. Reinstall the heparin pump into the machine cabinet. When installing the module screws do not use a power screwdriver
3. Place the machine in Dialysis Mode and clear all alarms.
4. Select<sup>1</sup> the Heparin screen key. On this screen select<sup>1</sup> the Syringe button. Use the [ + ] or [ - ] data entry keys to select the syringe being used for this test and press the [CONFIRM] key.
5. Select<sup>1</sup> the Load Syringe button. Press the [CONFIRM] key and the carriage will fully retract downward.
6. When the carriage has stopped, clean the carriage bar (See Figure 7).

<sup>1</sup> Refer to Section 1.3 on the use of screen buttons.

7. Extend the syringe plunger past the 10ml mark. Install the syringe into the pump and latch the plunger handle into the carriage. If needed, squeeze the carriage/plunger release lever to slide the carriage up to meet the plunger handle. The syringe plunger should be at a position greater than 10ml.

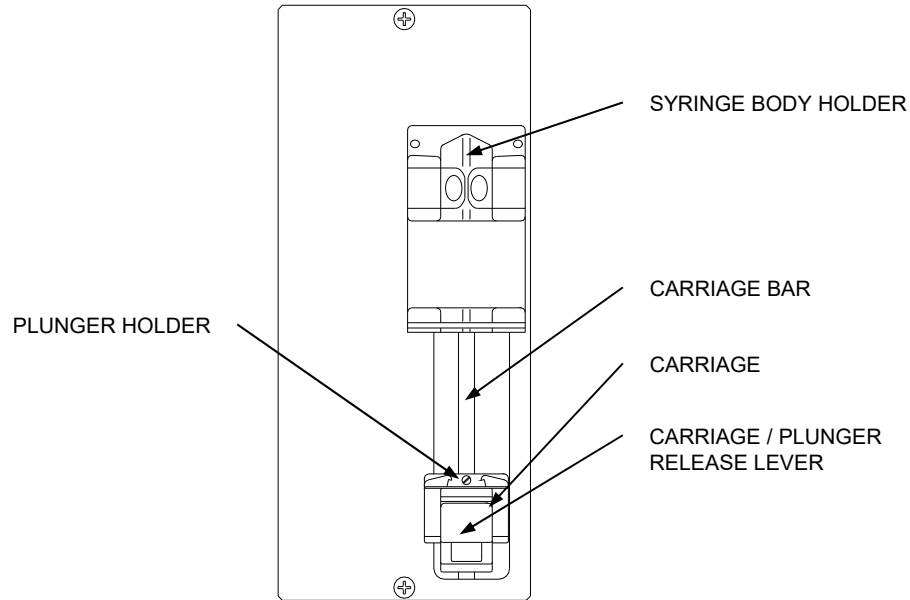

**Figure 7. Heparin Pump Module.**

8. Select<sup>1</sup> the Heparin Prime button. Press and hold the [CONFIRM] key. The plunger will start moving towards the 10ml mark. Release the [CONFIRM] key as soon as the syringe plunger is aligned exactly with the 10ml mark on the side of the syringe body.
9. Select<sup>1</sup> the Bolus data button. Use the [+ ] or [- ] data entry keys to set a value of 5.0ml then press the [CONFIRM] key.
10. Select<sup>1</sup> the Total Infused data button. Press the [0] (zero) key and then the [CONFIRM] key.
11. Select<sup>1</sup> the Infuse Bolus button. Press the [CONFIRM] key and start timing the interval with the stopwatch.

<sup>1</sup> Refer to Section 1.3 on the use of screen buttons.



12. When the pump stops, use the table below to verify the time to run a 5ml Bolus is correct for the selected syringe type.

Type	Syringe Size	5ml Bolus Time
B-D Black	10ml	29.4 – 30.4 seconds
Terumo	10ml (12ml)	24.5 – 25.5 seconds
Monoject	12ml	24.8 – 25.8 seconds
Braun	10ml	24.2 – 25.2 seconds
Monoject	10ml	24.8 – 25.8 seconds
Nipro	10ml	29.4 – 30.4 seconds
SOL-Care	10ml	27.7 – 28.7 seconds

13. Also, verify that the **Total Infused** data button reads 5.0 and that the syringe plunger has moved to between 4.8 to 5.2 on the syringe scale.
14. Move the carriage all the way up to the end of its travel.



**Note:** Use the Heparin Pump Prime function to move the carriage to the end of travel to ensure the screw gear stays fully engaged for the end of travel alarm test.

---

15. Select<sup>1</sup> the **RATE** data button. Use the **[+]** or **[-]** data entry keys to set a value of 9.9ml/hr. then press the **[CONFIRM]** key.
16. Press the **[Heparin on/off]** key to start the pump. The green lamp above the key should light.
17. Verify that a **HEPARIN PUMP ALARM** is displayed on the status line within 2 minutes.



**Note:** If the machine is not alarm free, another message of higher priority may be displayed on the status line.

---

<sup>1</sup> Refer to Section 1.3 on the use of screen buttons.

### 3.21 **BLOOD PUMP**

Clean and test the arterial blood pump module as follows:

1. Remove the blood pump rotor by opening the door, pulling out the handle and turning the rotor 90 degrees
2. Clean the rollers with a cloth dampened only with water.
3. With the crank lever pulled out, locate and lubricate the crank lever retainer ball. If the crank lever is hard to pull out, replace the crank lever retainer assembly (part number 564301).
4. Without removing the plastic sleeve, inspect the solid guide post on all four (4) tubing guides. The solid guide post should not be loose or bent. If any of the solid guide posts are loose or bent, the rotor assembly needs to be replaced (part number M30990).



**Note:** The plastic sleeve will make it feel like the solid guide post is loose. When inspecting, pay close attention to the movement of the metal shaft.

---

5. Clean the inside of the blood pump housing with the damp cloth. Compressed air may be used if it is available.
6. Remove the blood pump module from the machine and inspect the motor gearbox. In heavy use, some oil may accumulate on the gearbox housing. Wipe the housing clean.
7. Wipe the lower edge of the module and the blood pump cabinet opening to remove any residual disinfecting agent.
8. Reassemble the blood pump module and reinstall it in the machine cabinet. When installing the module screws do not use a power screwdriver.
9. Place the machine in Dialysis Mode and clear all blood alarms.
10. Start the blood pump if it is not already running.
11. Open the blood pump door. Verify that the red alarm light on the blood pump module lights within 15 or 30 seconds.



**Note:** Delay time before the blood pump alarm lights is set by dipswitch 4 on the LP955 blood pump board.

---

12. Close the blood pump door and press the [RESET] key to clear the alarm.

13. Test the pump as follows:

- Set the Tubing Size to 8mm.
- Insert a bloodline in the pump. Do not change the setting of the tubing size selector, even if you are not using 8mm tubing.
- Connect a pressure gauge to the bloodline in the pump (See Figure 8) and allow the rotor to pull up  $37^{\circ}\text{C} \pm 1.5^{\circ}\text{C}$  water. Let this fluid flow past the pressure gauge long enough to clear out air.

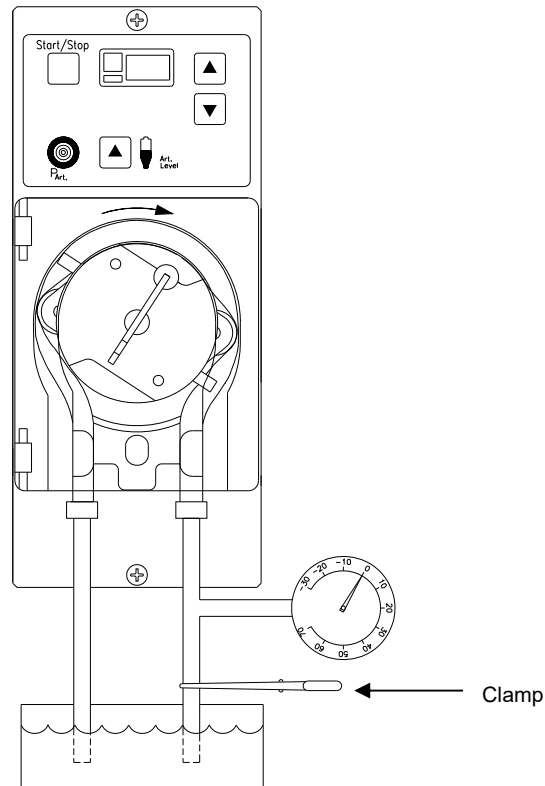

**Figure 8. Blood Pump Rotor Occlusion Test**

- With the pump running at 600ml/min, clamp the outlet so that the pressure gauge is between the output of the pump and the clamp (See Figure 8). The peak pressure on the gauge must be between 25 and 35psi. If the peak pressure is out of range, replace the blood pump rotor springs (part number 650174).
- Set the Tubing Size Selector to agree with the size of bloodline used in the pump.

## 3.22

### LEVEL DETECTOR

---



**Caution:** In the following steps, the level detector must be removed from the machine cabinet. Before returning it to the cabinet, wipe the lower edge of the module and the level detector cabinet opening to remove any residual disinfecting agent. When installing the module screws do not use a power screwdriver.

---

#### ALARM TEST

1. Perform the Level Detector calibration per the procedure outlined in the 2008K<sup>2</sup> Calibration Procedures (part number 508137).
2. Place the machine in Dialysis Mode and turn the blood pump ON. Insert a water filled venous chamber into the level detector and clear all alarms.
3. Position the Level Detector so you can watch the Channel 1 and Channel 2 LED's on the circuit board (See Figure 9).
4. While watching the Channel 1 and Channel 2 LED's, remove the venous chamber to create a blood alarm and close the occlusion clamp. Verify that the Channel 1 LED lights first followed quickly by Channel 2.

#### OCCLUSION CLAMP TEST

1. Place a venous line into the closed occlusion clamp. Do not connect this line to the venous chamber in the level detector.
2. Place the lower end of the venous line below the occlusion clamp in a container of water positioned so that air escaping from the end of the line is easily seen.

3. Connect a syringe and a pressure gauge to the venous line above the occlusion clamp.
4. With the syringe, apply a pressure of at least 30psi (1550mmHg) to the venous line while watching the end of the venous line in the water.
5. Verify that no air escapes from the venous line, indicating that the clamp is fully occluding the line.

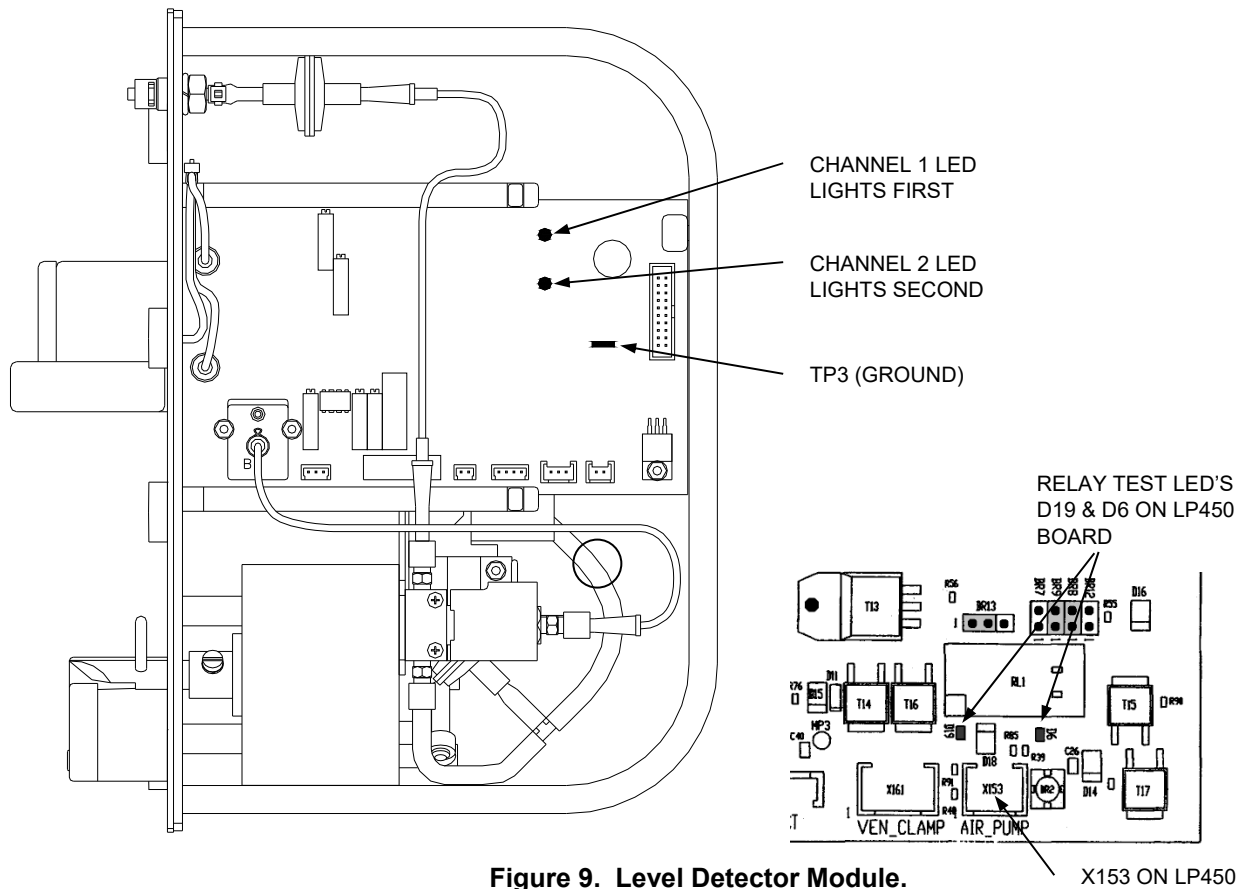

**Figure 9. Level Detector Module.**

X153 ON LP450

## RELAY CONTACT TEST

A relay prevents the level up and level down membrane keys on the face of the level detector to function if they are pressed at the same time. These relay contacts can be checked using the following steps:

- 1 With the machine in Dialysis Mode and the blood pump turned ON. Insert a water filled venous chamber into the level detector and clear all alarms
- 2 Locate the relay test LED's D6 and D19 on the LP450 board (see Figure 9).
- 3 To test the LED's, press the level down switch on the face of the level detector and verify that both LED's D6 and D19 light. The on-board air pump will also run. If both LED's light, proceed to step 4.



**Note:** If either LED doesn't light during the LED test (step 3), then the results of the Relay Contact Test (step 4) are invalid. In this case use the appropriate step below instead of step 4:

While in alarm condition (clamp closed), attach the ground lead of a voltmeter to TP3 (ground) on the LP450 board. Measure the voltage on the solder side of pins 1 and 2 of X153 on the LP450 board. Verify that both pins are 0 volts. If voltage is present, the relay contacts are bad.

---

- 4 To test the relay contacts, remove the venous chamber to create a blood alarm and verify that both LED's D6 and D19 do not light when the level down switch is pressed. If either LED lights, the relay contacts are bad.

### **3.23 ALARM OPERATION AND PRESSURE HOLDING TESTS**

Perform the Six (6) Month Preventive Maintenance procedures in Section 2.8.

### **3.24 VERIFY pH**

1. Place the machine into dialysis mode and allow it 10 minutes to stabilize.
2. Use a pH test strip (part number 335130-01 or equivalent) to verify the dialysate fluid is between the ANSI/AAMI RD52 standard of 6.9 and 7.6.
3. Record the measured value on the Annual/4000 Hour Preventive Maintenance Checklist.

### **3.25 RINSE CHECKS**

Perform the Rinse Checks as follows:

1. Place the machine in rinse mode, then turn the water supply off. Verify that the display screen shows **NO WATER**.
2. Turn water supply on.
3. Start rinse mode, and watch the flow from the drain line. The water from the drain line will stop at one point for 15 seconds. At this time put the drain line in a 1000ml graduated cylinder. Start timing when the flow starts again. At 30 seconds, remove the line from the graduated cylinder. Verify that a minimum of 310ml is collected.
4. Record the measured value on the Annual/4000 Hour Preventive Maintenance Checklist.
5. To avoid problems with pre-rinse, allow the rinse to complete prior to proceeding to the next step.
6. Open the shunt door and remove the dialysate lines.
7. Connect the dialysate lines to an external meter capable of reading at least 85°C.
8. Close the shunt door.
9. Start the machine in heat disinfect mode with the dialysate lines on the external meter as follows:
  - With the shunt door closed, reach up into the opening at the bottom of the shunt and find the two spring-loaded switches that protrude through the holes next to the connectors. Push these switches in with your fingers, simulating dialysate lines connected to the shunt.
  - While holding these switches pushed in, select<sup>1</sup> the Heat Disinfect button on the startup screen.
  - While holding the switches, open the shunt door. Verify the heat disinfect does not get interrupted.
  - Leave the shunt door open; closing it will stop the heat disinfect mode.

<sup>1</sup> Refer to Section 1.3 on the use of screen buttons.



**Warning!** Scalding hot water is passing through the dialysate lines and the external meter manifold. Allow the dialysate lines and the external meter manifold to cool before disconnecting the lines.

---

10. The heat disinfect timer will not be operating. It is not needed. Monitor the external temperature meter and verify that the temperature rises to between 80°C and 90°C.



**Note:** Some external temperature meters may not display correctly at higher temperatures. Consult the appropriate product literature from the meter manufacturer for applicable conversion charts.

---

11. Record the measured value on the Annual/4000 Hour Preventive Maintenance Checklist.

### 3.26 **POWER FAILURE ALARM AND BATTERY REPLACEMENT**

Remove the 9-volt battery located behind the monitor unit (See Figure 3, pg. 9). The battery is inside the plastic housing. Press the cover in and to the left to release it, then pull it out.



**Note:** If the 9-volt battery is swollen, the power logic board is bad and should be replaced.

---

With the battery removed, perform an Alarm Test and confirm the Battery Test fails.



**Note:** If the Battery Test passes with the 9-Volt battery removed, IC9 is bad on the Power Logic Board and should be replaced.

---

Replace the 9-volt battery with a new one observing the correct polarity marked inside the holder. Install the battery/holder assembly into the monitor unit.

With the new battery in place, perform an Alarm Test and confirm the Battery Test passes.

Test the power failure alarm by removing the machine power plug from the wall outlet with the machine powered on. Verify that the audible alarm sounds.



### 3.27

## **BLOOD PRESSURE MODULE**

---



**Note:** There are seven types of blood pressure modules that can be connected to the 2008K<sup>2</sup>. Since each module type has different test criteria and the 2008K<sup>2</sup> is unable to detect which module is connected, disregard the displayed Pass/Fail results if present and use the appropriate table to determine pass or fail.

---

Test the blood pressure module (See Figure 3, pg. 9), as follows:

Place the machine in Service Mode.

Select<sup>1</sup> the Test BP Module screen key and the screen will change.

### **INFLATION SPEED TEST**

From the Test BP Module screen, select<sup>1</sup> the Inflation Speed button.

1. Connect the 10 foot blood pressure tubing from the module to the 700cc port on the Test Device. Ensure the tubing fits snugly on the ports.
2. Press the [CONFIRM] key. The screen will change and the test will start.
3. The blood pressure module will pressurize the Test Device and report the time. When the test is complete, use the table below to verify that the Time to 250 value is within range dependent upon the module type installed.

<b>Module Type</b>	<b>Time to 250</b>
M400	≤ 7.3 seconds
M2000, M2600 or M3600	≤ 10.0 seconds
TM-2910 or TM-2915	≤ 10.0 seconds
SunTech	≤ 11.0 seconds

4. Press the [CONFIRM] key.

<sup>1</sup> Refer to Section 1.3 on the use of screen buttons.

## DEFLATION SPEED TEST



**Note:** The deflation speed test is not applicable to the SunTech module.

From the Test BP Module screen, select<sup>1</sup> the Deflation Speed button.

1. Connect the 10 foot blood pressure tubing from the module to the 220cc port on the Test Device. Ensure the tubing fits snugly on the ports.
2. Press the [CONFIRM] key. The screen will change and the test will start.
3. The blood pressure module will depressurize (deflate) the Test Device. The screen will change and report the deflation speed at various pressures in mmHg per second.
4. Use the table below to verify that the values reported are within the following ranges dependent upon the module type installed.

Model Type \ Pressure	RATE AT 240 (mmHg/sec)		RATE AT 160 (mmHg/sec)		RATE AT 80 (mmHg/sec)		RATE AT 40 (mmHg/sec)	
	Min	Max	Min	Max	Min	Max	Min	Max
M400	4.3	6.2	4.6	6.2	3.3	5.2	2.6	4.4
M2000 or M2600	4.4	6.7	4.4	6.7	3.0	5.2	2.4	4.6
M3600	3.8	6.6	3.8	6.6	2.8	5.5	2.3	4.6
TM2910 or TM-2915	3.5	7.5	3.5	7.5	3.5	7.5	3.5	7.5
SunTech	N/A	N/A	N/A	N/A	N/A	N/A	N/A	N/A

5. Press the [CONFIRM] key.

## AIR LEAKAGE TEST

From the Test BP Module screen, select<sup>1</sup> the Air Leakage button.

1. Connect the 10 foot blood pressure tubing from the module to the appropriate module specific port on the Test Device. (See table at the top of the next page). Ensure the tubing fits snugly on the ports.
2. Press the [CONFIRM] key. The screen will change and the test will start.
3. The blood pressure module will pressurize the Test Device as indicated by a rise in the Cuff Pressure displayed to approximately 290mmHg. An internal timer is then activated automatically. Any change in the pressure being held will show in the Cuff Pressure display.

<sup>1</sup> Refer to Section 1.3 on the use of screen buttons.

- At the end of the **Air Leakage** test, the pressure is automatically released, the screen will change and the **Leak Rate** in mmHg is displayed.
- Use the table below to verify that the **Leak Rate** value is within range dependent upon the module type installed.

Module Type	Test Device Port	Leak Rate
M400, M2000 or M2600	220cc	≤15mmHg
M3600	220cc	≤12mmHg
TM-2910 or TM-2915	700cc	≤30mmHg
SunTech	700cc	≤22mmHg

- Press the [CONFIRM] key.

## CALIBRATION CHECK

### For the M400, TM-2910 & TM-2915

- From the **Test BP Module** screen, select<sup>1</sup> the **Calibrate Mode** button.
- Disconnect the 10 foot blood pressure tubing from the Test Device and connect it to a mercury manometer or similar pressure meter accurate to within ±1mmHg.
- Press the [CONFIRM] key. The screen will change and the blood pressure module will pressurize the line.
- When the pressure shown on the display screen and on the external meter stabilizes, verify that they agree within ±3mmHg.



---

**Caution:** Do not exceed 330mmHg in the following step. The blood pressure module may be damaged if this pressure is exceeded.

---

- Over-Pressure Relief Check:**  
Remove the hose from the external meter and connect it to a large syringe (60cc) that has its plunger pulled back. Use the syringe to over-pressurize the blood pressure module while watching the display carefully. Use the table below to verify that the pressure is automatically released within range dependent upon the module type installed.

Module Type	Over-Pressure Release Range
M400	between 320 and 330mmHg
TM-2910 and TM-2915	between 310 and 330mmHg

<sup>1</sup> Refer to Section 1.3 on the use of screen buttons.

**For the M2000, M2600, M3600 & SunTech**

1. From the Test BP Module screen, select<sup>1</sup> the Air Leakage button.
2. Connect the 10 foot blood pressure tubing from the module to the appropriate module specific port on the Test Device. (See the table below). Ensure the tubing fits snugly on the ports.

Module Type	Test Device Port
M400, M2000, M2600 or M3600	220cc
TM-2910, TM-2915 or SunTech	700cc

3. Press the [CONFIRM] key. The screen will change and the blood pressure module will pressurize the line.
4. The blood pressure module will pressurize as indicated by a rise in the Cuff Pressure displayed to approximately 290mmHg. An internal timer is then activated automatically.
5. When the pressure shown on the display screen and on the external meter stabilizes, verify that they agree within  $\pm 3$ mmHg.
6. At the end of the Air Leakage test, the pressure is automatically released.
7. Over-Pressure Relief Check:  
Due to the microprocessor control of the M2000, M2600, M3600 and SunTech, the over-pressure relief check does not need to be conducted. In fact, an over- pressure relief test could permanently damage the module.

**3.28 FINAL CHECKS**

1. Check the machine for any optional components that are not included here. Perform the preventive maintenance tests provided with those units.
2. Perform the Six (6) Month Preventive Maintenance procedures in Section 2.11.

<sup>1</sup> Refer to Section 1.3 on the use of screen buttons.

## 4.0 **REBUILDING THE DIAPHRAGM PUMPS**

The machine contains two types of diaphragm pumps. The ultrafiltration (UF) pump is a solenoid coil type. The concentrate and bicarbonate pumps are stepper motor types.

## 4.1 **REBUILDING THE ULTRAFILTRATION PUMP**

Figure 10 shows an exploded view of the ultrafiltration pump. When working on the pump, be especially careful to do the following:

- Do not lose the wear button or the shim washers inside the pump solenoid.
- Count the shim washers when you disassemble the pump. The number of washers varies as needed to mate the solenoid to the pump properly.



**Caution:** Replace exactly the same number of shims in the ultrafiltration pump as were removed. The pump will not operate correctly if the same number of shims are not replaced.

Examine all components for signs of corrosion. Replace any components that show signs of excessive rust.

---



**Note:** If the UF pump does not provide output even though the green light is on and not flashing, inspect the check valves. If a check valve is installed backwards, the pump will not work.

---

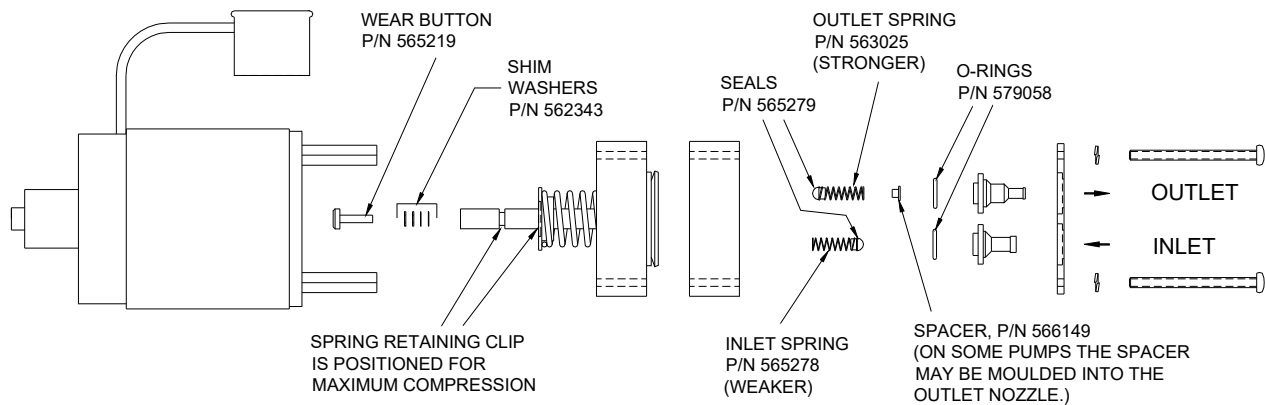

**Figure 10. Ultrafiltration Pump Exploded View.**

Rebuild the ultrafiltration pump as follows:

1. Remove the UF pump from the machine (See Figure 3, pg. 9). Make a note of which line goes to which port on the pump. When looking at the end plate, the arrow pointing into the pump nozzle is the input side. The arrow pointing away from the pump nozzle is the output side.
2. Hold the two sections of the pump housing and end plate together with one hand and remove the four long screws from the end plate.
3. Carefully remove the end plate to reveal the input and output nozzles, springs, seals and O-rings.
4. Replace the inlet and outlet springs.



**Caution:** Be certain the correct springs are used. The weaker spring goes on the inlet side. The stronger spring goes on the outlet side.

5. Inspect the seals. Replace them if there is any sign of swelling or wear.
6. Inspect the O-rings. Replace them if there is any sign of wear.



---

**Note:** Before reassembling the UF pump, verify nothing has fallen into the solenoid opening.

---

7. Reassemble the pump as follows:
  - The outlet seal goes toward the pump membrane.
  - The inlet seal faces away from the pump membrane.
  - Reinstall the spacer in the outlet nozzle if one was removed from the pump.
  - Ensure the outlet nozzle is oriented so it will be at the top of the pump solenoid to help avoid air locks in the pump.
8. Replace the long screws into the end plate and tighten.
9. Replace the pump in the machine and reconnect the electrical and hydraulic lines. Orient the pump so the outlet nozzle is above the inlet nozzle to help avoid air locks.
10. To displace air and to check for leaks, start a rinse and allow the machine to complete the entire rinse cycle.
11. Verify proper function of the UF pump by performing the Six (6) Month Preventive Maintenance procedures in Section 2.5.

## 4.2 REBUILDING THE CONCENTRATE AND BICARBONATE PUMPS

Figure 11 is an exploded view of the concentrate and bicarbonate pumps.

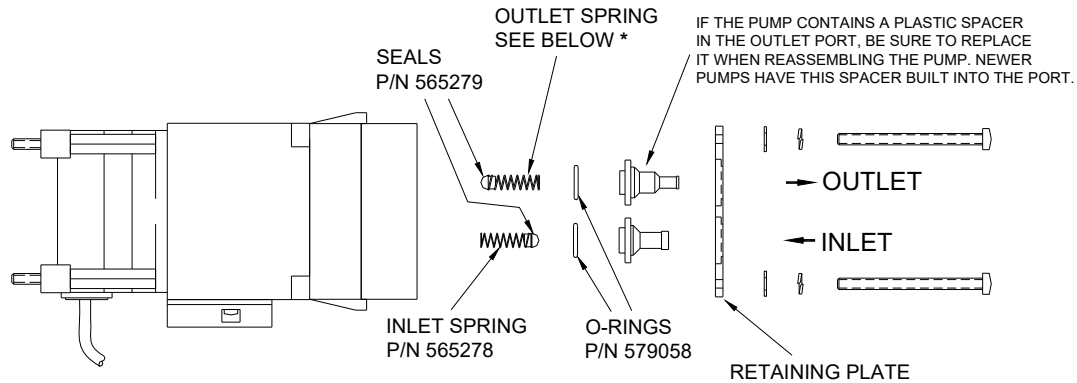

\* ON ACID AND BICARBONATE PUMPS USE WEAK SPRINGS FOR BOTH INLET AND OUTLET (P/N 565278).

**Figure 11. Concentrate and Bicarbonate Pump Exploded View.**

Rebuild the concentrate pumps as follows:

1. Remove the pump from the machine (See Figure 3, pg. 9). Make a note of which line goes to which port on the pump. When looking at the end plate, the arrow pointing into the pump nozzle is the input side. The arrow pointing away from the pump nozzle is the output side.
2. Hold the two sections of the pump housing and end plate together with one hand and remove the long screws that hold the end plate. On some models of the pump, four screws hold the end plate, and on others only two screws hold the end plate.

On pump models with four screws securing the end plate, replace one or two of them to avoid having the pump come completely apart. You only need access to the inlet seals and springs.



3. Carefully remove the end plate to reveal the input and output nozzles, springs, seals and O-rings.
4. Replace the inlet and outlet springs.



**Caution:** Be certain the correct springs are used on concentrate pumps. See Figure 11 on previous page.

---

5. Inspect the seals. Replace them if there is any sign of swelling or wear.
6. Inspect the O-rings. Replace them if there is any sign of wear.
7. Reassemble the pump as follows:
  - The outlet seal goes toward the pump membrane.
  - The inlet seal faces away from the pump membrane.
  - Reinstall the spacer in the outlet nozzle if one was removed from the pump.
  - Ensure the outlet nozzle is oriented so it will be at the top of the pump solenoid to help avoid air locks in the pump.
8. Replace the long screws into the end plate and tighten.
9. Reinstall the pump in the machine and reconnect the electrical and hydraulic lines. Orient the pump so the outlet nozzle is above the inlet nozzle to help avoid air locks.



**Note:** To avoid discoloration of the pump wiring, route the pump wiring away from heat sources such as the pump housing and valve coils when reinstalling the pump.

---

10. To displace air and to check for leaks, start a rinse and allow the machine to complete the entire rinse cycle.
11. Test the rebuilt diaphragm pump by performing the procedure described in Section 4.3.

### 4.3 TESTING CONCENTRATE AND BICARBONATE PUMPS

The concentrate (acid) and bicarbonate pumps are tested by measuring the volume of water they pump and comparing that measurement with the expected value determined by the machine. The measured pump volume must be within 2% of the expected value.

Test each pump as follows:

1. Place the machine in Dialysis Mode and open the shunt door.
2. Switch to the debug screens by pressing and holding the **[+]** and **[-]** data entry keys at the same time for approximately 1 sec. The main display will change indicating that the machine is in debug mode.
3. Use the **[+]** or **[-]** data entry keys to go to debug screen #1.
  - Locate the debug value for **FILACT**. In order to turn off dialysate flow later, **FILACT** must be 0.
  - Locate the debug value for **DOUBLE**. Certain types of Bicarbonate or higher Bicarbonate levels selected will require the pump to double stroke. If the debug value for **DOUBLE** is 1, the pump is double stroking. Before continuing the test, adjust the Bicarbonate level until the debug value for **DOUBLE** is 0.
  - If the debug values for the Bicarbonate Pump Volume (**BMIN** and **BMAX**) are showing 0 on debug screen #1, the machine is set up for a concentrate family that does not use bicarbonate. Change the concentrate selection to one requiring bicarbonate.



**Note:** The **AMIN**, **AMAX**, **BMIN**, **BMAX** are the expected limits for twenty pulses of the acid (concentrate) pump volume and the bicarbonate pump volume, respectively. These volumes are based on the measured volume of the balancing chamber to produce the correct mixing ratio.

---

4. Press the **[Dialysate Flow on/off]** key to stop dialysate flow.
5. Connect a 25ml buret filled with water to the concentrate connector for the pump to be tested. Use a short length of tubing forced over the end of the connector, and make sure there are no leaks in the fitting to the connector or to the buret.

6. With the machine in Dialysis Mode, press the [Dialysate Flow on/off] key to start the flow. Observe that liquid is drawn from the buret in discrete steps. Allow the machine to run and pump fluid from the buret for about 20 strokes, to prime the pump. Press the [Dialysate Flow on/off] key to stop the flow.



**Note:** Do not let the buret run dry so that air can enter the system.

---

7. Refill the buret exactly to the full mark. Press the [Dialysate Flow on/off] key to start the flow and count exactly 20 pulses of water drawn from the buret, then stop the flow.



**Note:** If DOUBLE=1 on debug screen #1 then count each pulse of the double stroking bicarbonate pump.

---

8. Measure the amount of water drawn from the buret carefully to within 0.05ml (within 1/2 division on a buret calibrated in 0.1ml increments). Verify that this value is between the displayed limits of AMIN and AMAX for the acid pump volume and BMIN and BMAX for the bicarbonate pump volume.
9. If a pump volume falls outside of the permitted error, repeat the above procedure to ensure that you are getting consistent results before recalibrating the machine.







# PREVENTIVE MAINTENANCE CHECKLIST ANNUAL/4000 HOUR

SERIAL NO. \_\_\_\_\_ DATE \_\_\_\_\_

MACHINE I.D. NO. \_\_\_\_\_ MACHINE HOURS \_\_\_\_\_

TECHNICIAN(S) \_\_\_\_\_ LABOR HOURS \_\_\_\_\_

See the Referenced Section of the 2008K<sup>2</sup> Preventive Maintenance Procedures (part number 508138 Rev. I) for detailed instructions to perform the following:

Reference Section	Procedure	Value	Completed By:
3.1	Clean Filters and Replace O-Rings.....		_____
3.2	Replace Pre-UF Pump Filter.....		_____
3.3	Replace UF Pump Check Valves.....		_____
3.4	Rebuild UF, Concentrate and Bicarbonate Pumps.....		_____
3.5	Check Ground Heater Element.....		_____
3.6	Check High Voltage AC Connections..... (≤0.2 ohms)	_____	_____
3.7	Replace Deaeration Motor Brushes..... (every 8000 hours)		_____
3.8	Check Inlet Water Pressure Regulator..... (Range: 18 to 20psi)	_____	_____
3.9	Conduct Online Clearance Test..... (If Applicable)		_____
3.10	Check Deaeration Pressure..... (Range: See Table 2 on page 26)	_____	_____
	Check Loading Pressure..... (Range: 18 to 20psi / with DIASAFE® Plus filter 23 to 25psi)	_____	_____
3.11	Check Flow Relief Pressure..... (Range: 29 to 30psi / with DIASAFE® Plus filter 35 to 36psi)	_____	_____
3.12	Test Concentrate and Bicarbonate Pumps.....		_____
3.13	Calibrate UF Pump..... (Range: 24 ± 0.1cc at 24 UF Pump strokes)	_____	_____
3.14	Check Conductivity Calibration..... (Range: Δ ± 0.1mS/cm)	Machine Display _____ External Meter _____	_____
3.15	Check Temperature Calibration..... (Range: 37 ± 0.3°C)	_____	_____
		(Range: 39 ± 0.3°C)	_____
3.16	Check Volt Hi Lo Detect..... (Range: 4.8 to 5.2 ± 0.2V)	_____	_____
3.17	Check Blood Leak Calibration..... (Range 4.5 to 5.2V)	_____	_____
	Check Dimness Calibration..... (Range 4.0 to 6.0V)	_____	_____
3.18	Check Arterial, Venous and TMP Calibration.....		_____
3.19	Check Dialysate Flow..... (Range @ 500ml/min: 485 to 515ml)	_____	_____
3.20	Check Heparin Pump..... (If Applicable)		_____
3.21	Check Blood Pump.....		_____
3.22	Check and Calibrate Level Detector.....		_____
3.23	Check Alarm Operation and Pressure Holding Tests.....		_____
3.24	Verify pH..... (Range 6.9 to 7.6)	_____	_____
3.25	Rinse Check..... (Range: ≥ 310ml collected)	_____	_____
	Heat Disinfect Check..... (Range: 80 to 90°C)	_____	_____
3.26	Check Power Failure Alarm.....		_____
	Replace 9-Volt Battery.....		_____
3.27	Check Blood Pressure Module.....		_____
3.28	Final Checks.....		_____





# COMMON CONVERSIONS

## PRESSURE

1 Bar	29.53 inHg
1 inHg	25.4 mmHg
1 Psi	51.72 mmHg

## VOLUME

1 FLUID OUNCE	29.6 MILLILITERS
1 U.S QUART	0.946 LITERS
1 U.S. GALLON	3.8 LITERS
0.034 FLUID OUNCES	1 MILLILITER
1.057 QUARTS	1 LITER
0.26 U.S. GALLON	1 LITER

## MASS

1 OUNCE (avdp.)	28.35 GRAMS
1 POUND (avdp.)	0.45 KILOGRAM
0.035 OUNCE (avdp.)	1 GRAM

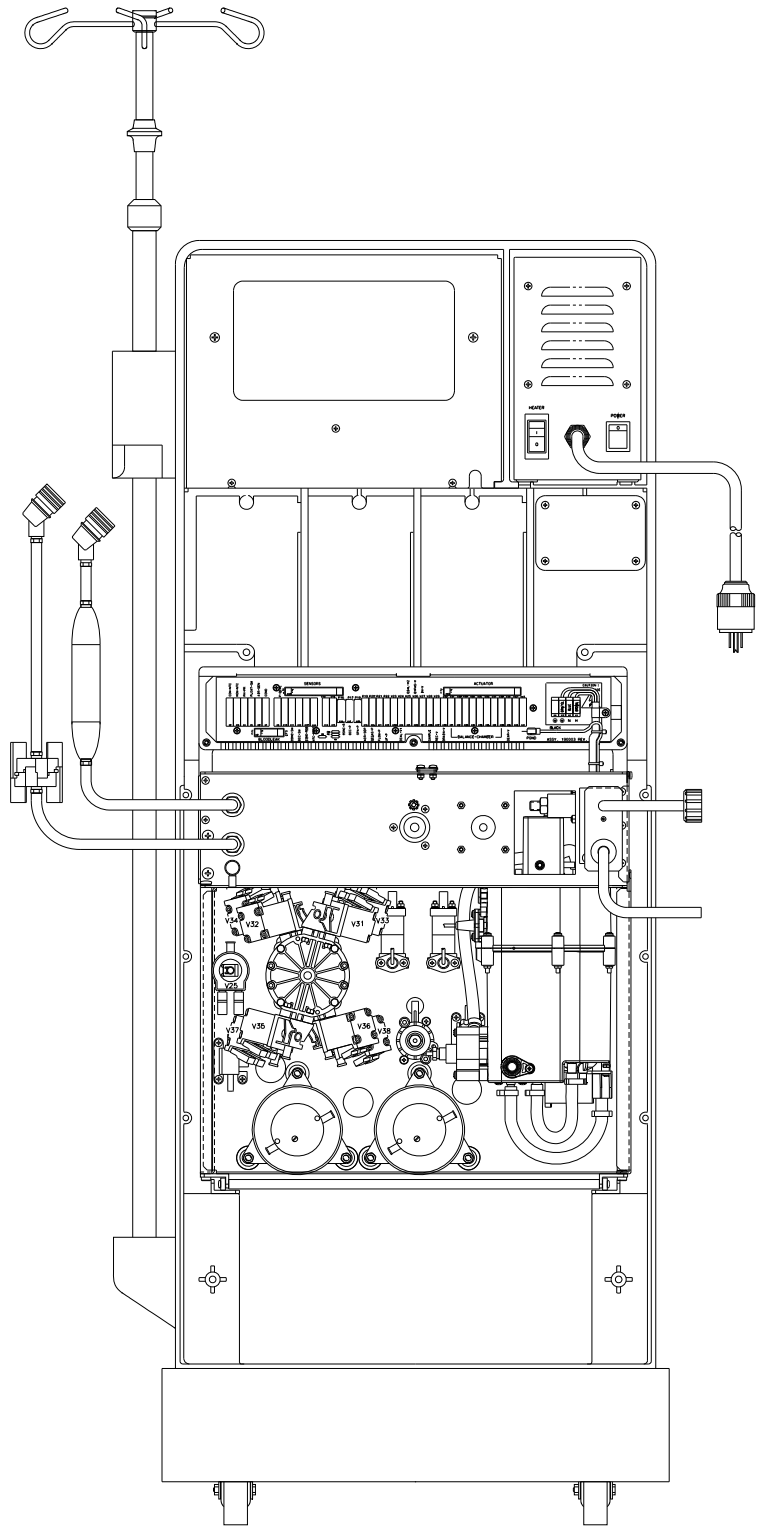

**Fresenius Medical Care North America**  
Manufactured by:  
Fresenius USA, Inc.  
4040 Nelson Avenue  
Concord, CA 94520  
800 227-2572

<http://www.fmcna.com>